



# Commercial Flooring Solutions

2025 Collection

**Gerflor**<sup>®</sup>

## Formats

With foam backing (Comfort)



Without foam backing (Compact)

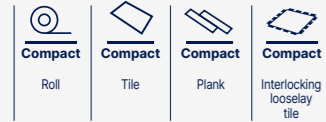

## Performances

**17 dB**

Sound insulation in dB  
(EN ISO 717-2)

**R10**

Slip resistance wet  
(DIN 51130)

**10<sup>5</sup>**

Electrical resistance in  $\Omega$  :  
 $5 \times 10^4 \leq R \leq 10^6$   
(EN 1081/DIN 51953)

**10<sup>7</sup>**

Electrical resistance in  $\Omega$  :  
 $10^6 \leq R \leq 10^8$   
(EN 1081/DIN 51953)



Very high density foam

**100% recyclable**

## Treatments

**evercare™**

Micro structured cross coat  
Polimerised laser technology

**PROTECSOL® 2**

Polyurethane surface  
Treatment UV cured  
Stain shield  
Matt effect

**Protectsol®  
Protectsol® Mat**

Polyurethane surface  
Treatment UV cured

**ProtectShield™  
Pur+ Matt**

Polyurethane  
surface treatment  
Matt surface

**Pur+**

Polyurethane surface  
treatment

**Pur**

Polyurethane surface  
treatment

**Sparclean®**

Powder coated  
treatment

**neocare™**

New exclusive  
Linoleum surface protection

## Certification



Scale reduction for Wood designs.  
The images of floorcoverings in this catalogue have been reproduced as faithfully as printing technology permits.

Creation 70 Looselay  
Chips Blue

## 8-33. Mipolam Homogeneous

**Evercare™**  
Mipolam Symbioz™  
Mipolam Planet & Bioplanet  
Mipolam Affinity  
Mipolam Accord  
Mipolam Cosmo  
Mipolam Troplan

**PUR**  
Mipolam Classic

## 34-53. Premium **New**

Poesy  
Neopolis  
Metallica  
Osmoz  
Indiana  
Brazilia  
Neoterra  
Cocoon  
Premium ZERO **New**

## 54-123. Taralay Multilayered

**Taralay Millenium**  
**Taralay Libertex**  
**Taralay Impression**  
**Taralay Impression hcp**  
**My Taralay Impression**  
**Taralay Initial**  
**Nerok**  
**Tarastep Pro**

## 124-227. Creation Tiles & planks

**Creation 70**  
Creation 70  
Creation 70 Clic  
Creation 70 Looselay **New**  
Creation 70 Connect  
**Creation Saga² **New****  
**Creation 55**  
Creation 55  
Creation 55 Solid Clic  
Creation 55 Rigid Acoustic  
Creation 55 Looselay **New**  
Creation 55 Looselay Acoustic **New**

**Creation 40**  
Creation 40  
Creation 40 Solid Clic  
Creation 40 Rigid Acoustic

**Creation 30**  
Creation 30  
Creation 30 Solid Clic

**My Creation**  
**My Saga²**

## 228-239. Carpet Tiles

**Armonia 400 **New****  
**Armonia 520/620 **New****

## 240-255. Wall Solutions

**Wall panels & tiles**  
Mural Revela **New**  
Mural Revela accessories **New**

**Wall coverings**  
Mural Ultra Design  
Mural Club  
Mural Calypso **New**

## 256-277. Fast Track High Traffic Tiles

**GTI® Max**  
**GTI® Pure**  
**GTI® EL5**

**Attraction®**  
**Design tile **New****  
**R-tile **New****

## 278-297. Technical solutions

**EL5 / EL7 solutions  
(Dissipative & conductive floors)**  
Mipolam EL7  
Mipolam Robust EL7  
Mipolam EL5  
Mipolam Technic EL5  
GTI® EL5

**Safety flooring**  
Tarasafe Ultra **New**  
Tarasafe Standard **New**  
Tarasafe Plus/Super  
Tarasafe Ultra H<sub>2</sub>O

**Shower System**  
Tarasafe H<sub>2</sub>O **New**  
Tarasafe Ultra H<sub>2</sub>O  
Tarasafe Design  
Mural Calypso **New**

## 298-327. DLW Linoleum

**Compact Linoleum**  
Marmorette  
Colorette  
Uni Walton  
Lino Art Urban  
Lino Art Metallic  
Lino Art Star

**Acoustic Linoleum**  
Marmorette Acoustic  
Marmorette Acoustic Plus  
Colorette Acoustic Plus  
Uni Walton Acoustic Plus  
Lino Art Urban Acoustic Plus

**Technical Solutions**  
High mechanical Traffic Linodur  
Dissipative Linoleum Marmorette LCH

## 328-371. Sport flooring

**Taraflex® **New****  
Synthetic Sport Flooring

**Connor Sports®**  
Hardwood Flooring Systems

**Sport Court®**  
Outdoor Surfaces

**DLW**  
Linoleum Sport Flooring

**Powershock**  
Fitness Rubber Solutions

## 372-401. Finishes

**Finishes**  
Skirting solutions  
Stair solutions  
Profile solutions  
Welding solutions  
Entrance mats solutions

**Installation solutions**  
Shower system  
Accessibility  
Acoustic underlayers  
Specific products  
Adhesives and tapes

**Sport finishes**  
Paint and marking for boundary lines

## 402-409. Specifications



# Gerflor presentation

Since 1937, Gerflor **has designed, manufactured and distributed design-led, innovative and eco-responsible** floor coverings and wall protection solutions. Present in more than **100 countries**, with **5200 employees, 30 subsidiaries** and **24 production sites**, Gerflor serves many activity sectors including health, education, residential accommodation and sport.

## Worldwide presence for better service



America  
● Sales offices ● Manufacturing plants ● Head office

**30** sales offices    **24** manufacturing plants and logistic hubs    **5** Technocentres

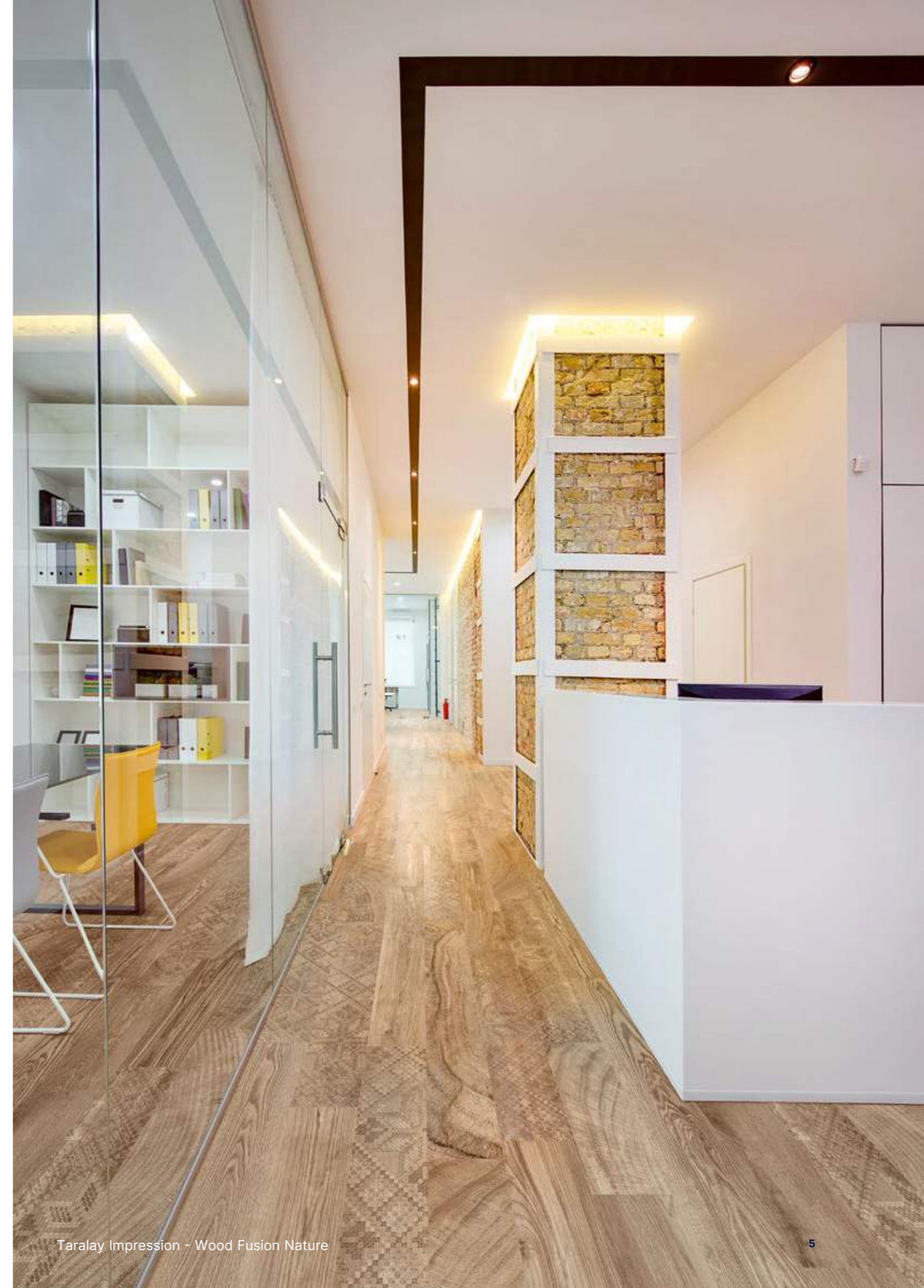



# Our commitments for a sustainable future

Gerflor teams have always considered customers and the environment as their absolute priorities. Our floor coverings, wall solutions and finishing components are user friendly, healthy solutions. They are designed with respect for our planet to last as long as possible with proposed end-of-life options. From product design through end-of-life, the circular economy is a core priority for the group. We have determined 5 priority commitments to guide our environmental management up to 2025.

## We care / we act Our Commitments for a Sustainable future



**CARBON FOOTPRINT\***  
-20 % kg  
CO<sub>2</sub> equivalent/m<sup>2</sup>  
between 2020 and 2025



**BIOSOURCED CONTENT\*\***  
10 % by 2025



**RECYCLED CONTENT**  
30 % by 2025



**ADHESIVE FREE\*\*\***  
35 % by 2025



**ANNUAL VOLUME RECYCLED**  
60 000 t by 2025

\* Scopes 1 and 2 defined in the GHG protocol \*\* % of activity with biosourced materials \*\*\* % of activity - adhesive free solution







# Mipolam Homogeneous

pages 8-33

- 12. Mipolam Homogeneous Evercare™**
- 14. Mipolam Symbioz™
- 18. Mipolam Planet & Bioplanet
- 24. Mipolam Affinity
- 28. Mipolam Accord
- 30. Mipolam Cosmo
- 31. Mipolam Troplan
  
- 32. Mipolam Homogeneous PUR**
- 32. Mipolam Classic



# Mipolam Homogeneous

Type Binder content EN ISO 10581

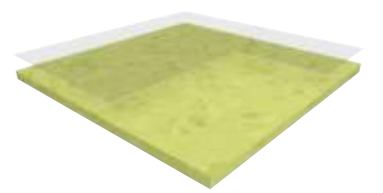

Mipolam  
Symbioz™  
 Bio Content  
17 %

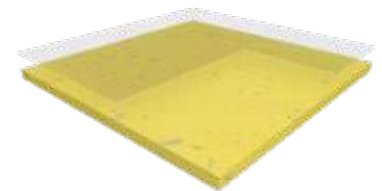

Mipolam Planet  
Mipolam Bioplanet  
 Bio Content  
17 %

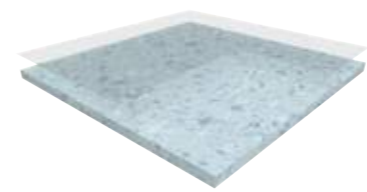

Mipolam Affinity  
Mipolam Accord



Mipolam Cosmo

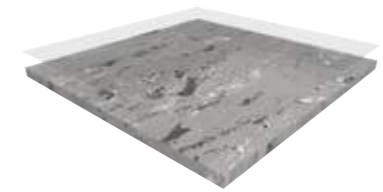

Mipolam Troplan

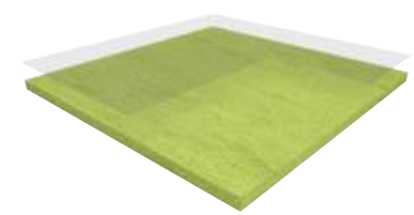

Mipolam Classic

**An exclusive and Gerflor patented surface treatment.**

- Stain shield**
- No wax for life Water and detergent savings**
- Matt effect: enhanced design**
- Anti-bacterial & anti-viral activity**  
ISO 22196 & ISO 21702

PUR Treatment

Evercare™ Treatment



Maintenance



# Mipolam Homogeneous Evercare™

## Mipolam Symbioz™

Mipolam Symbioz™

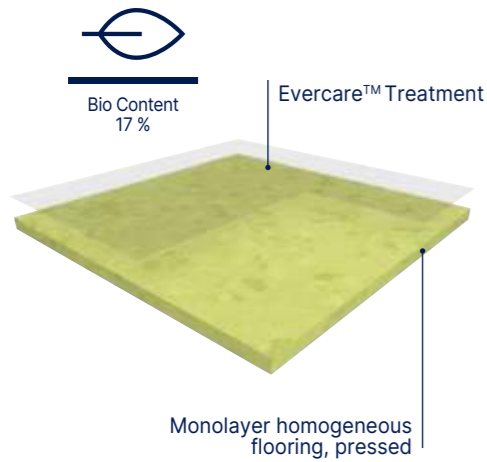

**MIPOLAM SYMBIOZ™** is fully flexible homogeneous compacted floorcovering in sheet, 2m wide, providing excellent resistance to wear and tear in high traffic areas. Their weight is **2595 gr/m²**. They feature a non-directional design incorporating coloured chips to ensure an even colour throughout the thickness presenting a **nice matt finish**.

Comprising 83% natural and recycled content, including 17% bio content, 45% mineral raw material (Salt & chalk) and 21% recycled content, **MIPOLAM SYMBIOZ™** achieves a 20% to 30% reduction in Cradle to Gate CO2 emissions compared to standard homogeneous flooring. It is 100% phthalates free and recyclable. This floorcovering is a non-emissive product (below the level of VOC measurement accuracy).

According to ISO 21702, **MIPOLAM SYMBIOZ™** has **anti viral activity** against Human Coronaviruses: it reduces the number of virus by 99,7% after 2h00.

According to ISO 22196, **MIPOLAM SYMBIOZ™** has **anti bacterial activity** against E. coli, S. aureus and MRSA of 99% after 24h00. The flooring is equipped with **Evercare™**, patented surface treatment obtained by **UV laser cross-linking** offering the **best chemical resistance to the main products used in healthcare** environment as Betadine, eosin, hydro alcoholic solutions, making the maintenance easy and long lasting the flooring.

This treatment **avoids applying any acrylic emulsion** throughout the lifetime of the product.

The flooring is **antistatic** (<2kV), its residual indentation is ≈ 0.02 mm. The flooring complies with the EN ISO 10581 norm, has a binder content Type I and is suitable for heavy duty traffic areas and **Bfl-s1 fire** resistance.

As part of our sustainable development policy, this product is manufactured in the first floor covering plant awarded with the triple certification: ISO 9001 (quality), ISO 14 001 (environment) and OHSaS 18001 (safety).



**BBR40:**  
100% Bio-based plasticizer rod for Mipolam Symbioz™  
(see page 385)



Evercare™



100% recyclable

**Mipolam Symbioz™ have been engineered using a full life cycle model, to guarantee the lowest environmental impact at every stage of the product life**

- ▶ **Highest durability:** product life expectancy > 20 years
- ▶ **Eco-responsible exclusive Bio based plasticizer, 100% made from organic source**
- ▶ **Evercare™:** patented polyurethane surface treatment with unique performance in staining providing chemical resistance
- ▶ **Easy maintenance:** no wax for life
- ▶ **On average 30% savings on maintenance cost**
- ▶ **15% less detergent and water use.**

**Indoor Air Quality: very low emitting material (40 times lower than European standards).**

Mipolam Symbioz™			
Description			
Total thickness	EN ISO 24346	mm	2
Weight	EN ISO 23997	g/sqm	2595
Width of sheet	EN ISO 24341	cm	200
Length of sheet	EN ISO 24341	lm	20
<b>Classification</b>			
Norm / Product specification	-	-	EN ISO 10581
European classification	EN ISO 10874	class	34-43
Fire rating	EN 13501-1	class	Bfl-s1
Static electrical propensity	EN 1815	kV	< 2
Slip resistance	EN 16165:2021 – Appendix B (DIN 51 130)	class	R9
<b>Performances</b>			
Type Binder content	EN ISO 10581	type	I
Dimensional stability	EN ISO 23999	%	≤ 0.40
Impact Sound Insulation	EN ISO 717-2	dB	5
Residual indentation (norm)	EN ISO 24343-1	mm	≤ 0.10
Residual indentation (average measured value)	-	mm	≈ 0.02
Castor chair test (type H)	ISO 4918	-	OK
Thermal conductivity	EN ISO 10456	W/(m.k)	0.25
Colour fastness	EN ISO 105-B02	degree	≥ 6
Surface treatment	-	-	Evercare™
Chemical products resistance	EN ISO 26987	class	OK
Anti-bacterial activity (E. coli - S. aureus - MRSA) after 24h <sup>(1)</sup>	ISO 22196	-	> 99% inhibits growth
Anti-viral activity (human coronavirus) after 2h <sup>(1)</sup>	ISO 21702	-	> 99.7% virucidal activity
<b>Environment / Indoor Air Quality</b>			
TVOC after 28 days	ISO 16000-6	microgram/m³	< 10
Certification	-	-	Floorscore®
<b>CE Marking</b>			



EN 14041



(1) The implementation of an effective cleaning regime is the most important defence against infection.



# Mipolam Homogeneous Evercare™

Mipolam Symbioz™



Evercare™



100% recyclable



Bio Content  
17%

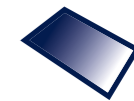

Matt finish











6027 Acacia



^ Scale 1



6027 Acacia

 6002 Lipica 	 6030 Stonehenge 	 6050 Hurricane 	 6056 Tulum 
 6001 Cotton 	 6009 Grey Stone 	 6036 Oceania 	 6058 Vermiglio 
 6005 Ghibli 	 6008 Calico 	 6037 Lagoon 	 6018 Ushuaia 
 6031 Breeze 	 6010 Mist 	 6006 Blue Sky 	 6075 Cardinal 
 6034 Mole 	 6029 Cloud 	 6047 Sauge 	 6065 Segesta 
 6041 Clay 	 6039 Pebble 	 6057 Musk 	 6025 Tangelo 
 6043 Wood 	 6044 Sea Storm 	 6067 Kaki 	 6032 Sunshine 
 6045 Chocolate 	 6059 Black Diamond 		



# Mipolam Homogeneous Evercare™

## Mipolam Planet & Bioplanet

### Mipolam Planet & Bioplanet

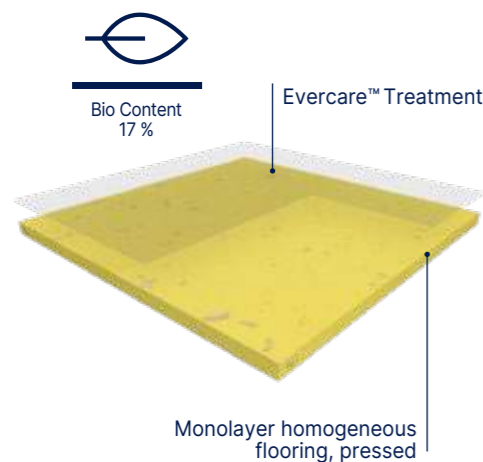

**MIPOLAM PLANET** is fully flexible homogeneous compacted floorcovering in sheet, 2 m wide, providing excellent resistance to wear and tear in high traffic areas. Their weight is **2700 gr/m<sup>2</sup>**. They feature a non-directional design incorporating translucent chips that provides a 3D effect and ensures an even colour throughout the thickness presenting a nice matt finish over 40 colours. The flooring is equipped with **Evercare™**, patented surface treatment obtained by UV laser cross-linking offering the best chemical resistance to the main products used in healthcare environment as betadine, eosin, hydro alcoholic solutions, making the maintenance easy and the floor long lasting. This treatment avoids applying any acrylic emulsion throughout the lifetime of the product. It is free of formaldehyde, heavy metals and CMR 1 & 2 or vPvB (very persistent and very bio-accumulative) or PBT (persistent, bio-accumulative and toxic) and is REACH compliant. It is **100% phthalates free and recyclable**. Its VOC emissions after 28 days (ISO 16000-6) are below detection levels (< 10 microgram/m<sup>3</sup> and g/m<sup>3</sup>) and this product is classified A + (the best class). According to ISO 21702, Mipolam Planet has **anti-viral activity** against Human Coronaviruses: it reduces the number of virus by 99.7% after 2h00. According to ISO 22196, Mipolam Planet has **anti-bacterial activity** against E. coli, S. aureus and MRSA of 99% after 24h00. The flooring is **antistatic** (< 2 kV), its residual indentation is ≈ 0.02 mm. The flooring complies with the EN ISO 10581 norm, has a binder content Type I and is suitable for heavy duty traffic areas and **Bfl-s1 fire resistance**. As part of our sustainable development policy, this product is manufactured in the first floor covering plant awarded with the triple certification: ISO 9001 (quality), ISO 14 001 (environment) and OHSaS 18001 (safety).

**MIPOLAM BIOPLANET** is fully flexible homogeneous compacted floorcovering in sheet, 2 m wide, providing excellent resistance to wear and tear in high traffic areas. Its weight is **2700 gr/m<sup>2</sup>**. It features a non-directional design incorporating translucent chips that provides a 3D effect and ensures an even colour throughout the thickness presenting a nice matt finish over 40 colours. It contains over 75% sustainable of renewable raw materials. It include a 100% bio based plasticizer, made of residues from non-agricultural food. The flooring is equipped with **Evercare™**, patented surface treatment obtained by UV laser cross-linking offering the best chemical resistance to the main products used in healthcare environment as betadine, eosin, hydro alcoholic solutions, making the maintenance easy and the floor long lasting. This treatment avoids applying any acrylic emulsion throughout the lifetime of the product. It is free of formaldehyde, heavy metals and CMR 1 & 2 or vPvB (very persistent and very bio-accumulative) or PBT (persistent, bio-accumulative and toxic) and is REACH compliant. It is **100% phthalates free and recyclable**. Its VOC emissions after 28 days (ISO 16000-6) are below detection levels (< 10 microgram/m<sup>3</sup> and g/m<sup>3</sup>) and this product is classified A + (the best class). According to ISO 21702, Mipolam Bioplanet has **anti-viral activity** against Human Coronaviruses: it reduces the number of virus by 99.7% after 2h00. According to ISO 22196, Mipolam Bioplanet has **anti-bacterial activity** against E. coli, S. aureus and MRSA of 99% after 24h00. The flooring is **antistatic** (< 2 kV), its residual indentation is ≈ 0.02 mm. The flooring complies with the EN ISO 10581 norm, has a binder content Type I and is suitable for heavy duty traffic areas and **Bfl-s1 fire resistance**. As part of our sustainable development policy, this product is manufactured in the first floor covering plant awarded with the triple certification: ISO 9001 (quality), ISO 14 001 (environment) and OHSaS 18001 (safety).



- ▶ **Recycled content up to 25%, 100% Recyclable**
- ▶ **Bio content 17% (Mipolam BioPlanet - on demand)**
- ▶ **Anti-viral activity & Anti-bacterial activity**  
**Indoor air quality: TVOC 100 times below standard**
- ▶ **40 COLOURS: Bright and subtle non directional design**
- ▶ **Heavy traffic resistance**
- ▶ **Ease of maintenance thanks to Evercare™**

			Mipolam Planet	Mipolam BioPlanet	Mipolam Planet R10
<b>Description</b>					
Total thickness	EN ISO 24346	mm	2	2	2
Weight	EN ISO 23997	g/sqm	2700	2700	2700
Width of sheet	EN ISO 24341	cm	200	200	200
Tile size	EN ISO 24342	mm	608 × 608 <sup>(1)</sup>	608 × 608 <sup>(1)</sup>	608 × 608 <sup>(1)</sup>
Length of sheet	EN ISO 24341	lm	20	20	20
<b>Classification</b>					
Norm / Product specification	-	-	EN ISO 10581	EN ISO 10581	EN ISO 10581
European classification	EN ISO 10874	class	34-43	34-43	34-43
Fire rating	EN 13501-1	class	Bfl-s1	Bfl-s1	Bfl-s1
Static electrical propensity	EN 1815	kV	< 2	< 2	< 2
Slip resistance	EN 16165:2021 – Appendix B (DIN 51 130)	class	R9	R9	R10
<b>Performances</b>					
Type Binder content	EN ISO 10581	type	I	I	I
Dimensional stability	EN ISO 23999	%	sheet < 0.40	sheet < 0.40	sheet < 0.40
Dimensional stability (average measured value)	-	%	sheet ≈ 0.10	sheet ≈ 0.10	sheet ≈ 0.10
Impact Sound Insulation	EN ISO 717-2	dB	5	5	5
Residual indentation (norm)	EN ISO 24343-1	mm	≤ 0.10	≤ 0.10	≤ 0.10
Residual indentation (average measured value)	-	mm	≈ 0.02	≈ 0.02	≈ 0.02
Castor chair test (type H)	ISO 4918	-	OK	OK	OK
Decontamination	ISO 8690	-	Excellent	Excellent	Excellent
Watertightness	EN 13553	Annex A	Pass	Pass	Pass
Thermal conductivity	EN ISO 10456	W/(m.k)	0.25	0.25	0.25
Colour fastness	EN ISO 105-B02	degree	≥ 7	≥ 7	≥ 7
Surface treatment	-	-	Evercare™	Evercare™	Evercare™
Chemical products resistance	EN ISO 26987	class	OK	OK	OK
Anti-bacterial activity (E. coli - S. aureus - MRSA) after 24h <sup>(2)</sup>	ISO 22196	-	> 99% inhibits growth	> 99% inhibits growth	> 99% inhibits growth
Anti-viral activity (human coronavirus) after 2h <sup>(2)</sup>	ISO 21702	-	> 99.7% virucidal activity	> 99.7% virucidal activity	> 99.7% virucidal activity
<b>Environment / Indoor Air Quality</b>					
TVOC after 28 days	ISO 16000-6	microgram/m <sup>3</sup>	< 10	< 10	< 10
Certification	-	-	Floorscore®	Floorscore®	Floorscore®
<b>CE Marking</b>					



EN 14041

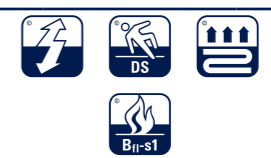

(1) Products available in tiles for a minimum quantity order of 500 sqm.  
 (2) The implementation of an effective cleaning regime is the most important defence against infection.



# Mipolam Homogeneous Evercare™

Mipolam Planet & Bioplanet

 Evercare™
  100% recyclable

  
**Matt finish**



5404 Vanilla Sky  

^ Scale 1



5403 Moon Dust  





5402 Ivory Dust  



5412 Moon Stone  



5424 Hawk Eye  



5439 Moon Way



5441 Clay Soil  

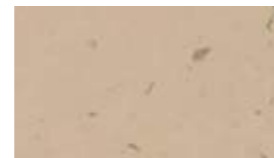

5432 Sun Stone  

5418 Terra Nera  





5422 Sunflower  



5438 Andalusite  



5428 Shedded Ground  



5443 Wood Path  



5445 Tree Bark  



5444 Rocky Hill  





5482 Sugar Drip  



5406 Moqui  



5430 Sideral Grey  



5460 Lava Stone  





5437 Reef Water  





5416 Aquamarina  



5450 Blended Ashes  



5459 Stormy Cloud  



5417 Foggy Hill  



5426 Shadow  



5420 Stone Powder  



5429 Fog Patch  



5427 Green Zest  





5436 Tiger Eye  



5413 Rain Fall  



5439 Moon Way  



5447 Aventurine  



5456 Intense Indigo  



5410 Silex  



5411 Atlantic Grey  



5455 Lava Flow  



5466 Rocky Blue  



5408 Chalk Dust  



5409 Pebble Beach  



5475 Intense Ruby  





5446 Blue Nug  



# Mipolam Homogeneous Evercare™

Mipolam Affinity / Accord / Cosmo / Troplan

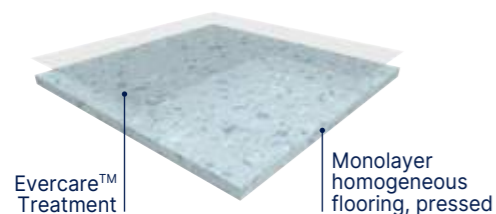
## Mipolam Affinity



**MIPOLAM AFFINITY** is a vinyl flooring homogeneous pressed in 2 m sheets, with a thickness of 2 mm and a **weight of 2800 g**. The non-directional design with colour throughout the thickness is available in 50 references presenting a contrasted designed & a **matt finish**. This flooring is recommended for collective buildings making skirtings easier, as well as angles and welding. The flooring is equipped with **Evercare™**, patented surface treatment obtained by **UV laser cross-linking** offering **the best chemical resistance to the main products used in healthcare** environment as Betadine, eosin, hydro alcoholic solutions, making the maintenance easy and the floor long lasting. This treatment **avoids applying any acrylic emulsion** throughout the lifetime of the product. According to ISO 21702, **MIPOLAM AFFINITY** has **anti-viral activity** against Human Coronaviruses: it reduces the number of virus by 99.7% after 2h. According to ISO 22196, **MIPOLAM AFFINITY** has **anti-bacterial activity** against E. coli, S. aureus and MRSA of 99% after 24h. It is free of formaldehyde, heavy metals and CMR 1 & 2 or vPvB (very persistent and very bio-accumulative) or PBT (persistent, bio-accumulative and toxic) and is **REACH compliant**. It is 100% phthalate free and recyclable. Its VOC emissions after 28 days (ISO 16000-6) are below detection levels (<10 microgram/m<sup>3</sup>) and this product is classified A + (the best class). This flooring is **antistatic** (< 2 kV), its residual indentation is ≤ 0.02 mm to 150 minutes respecting EN ISO 24343-1. This flooring complies with EN ISO 10581 offering a Binder content Type I, which makes it suitable for heavy duty traffic areas. It has a **Bfl-s1 fire** resistance.

## Mipolam Accord

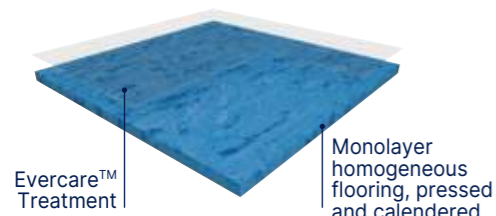

**MIPOLAM ACCORD** is a vinyl flooring homogeneous calendered and pressed in 2m sheets, with a thickness of 2 mm and a **weight of ≤ 2790 g**. The semi-directional design with colour throughout the thickness is available in 28 references presenting a nice **matt finish**. This flooring is recommended for collective buildings making skirtings easier, as well as angles and welding. The flooring is equipped with **Evercare™** the latest improvements in polyurethane surface treatment obtained by **UV laser cross-linking**. This Evercare™ **avoids staining of chemical products used in Healthcare** like Betadine, eosin or anti-bacterial hand gel and increases the durability of the flooring. This treatment has excellent maintenance characteristics and does not require the application of acrylic polishes. According to ISO 21702, **MIPOLAM ACCORD** has **anti-viral activity** against Human Coronaviruses: it reduces the number of virus by 99.7% after 2h. According to ISO 22196, **MIPOLAM ACCORD** has **anti-bacterial activity** against E. coli, S. aureus and MRSA of 99% after 24h. The flooring is composed of minimum **25% recycled content 100% controlled** and is **REACH compliant**. It is 100% phthalate free and 100% recyclable. This flooring is **antistatic** (<2kV). The product is non-reactive to residual indentation with a value ≤ 0.02 mm to 150 minutes respecting EN ISO 24343-1. The flooring is compliant with EN ISO 10581 norm, has a binder content type I, is suitable for heavy duty traffic areas and has a **Bfl-s1 fire** resistance. The product emission rate of volatile organic compounds is < 10 microgram/m<sup>3</sup> (TVOC after 28 days ISO 16000-6).

## Mipolam Cosmo



**MIPOLAM COSMO** is a vinyl flooring homogeneous calendered and pressed in 2 m sheets, with a thickness of 2 mm and a **weight ≤ 3000 g**. The semi-directional design with colour throughout the thickness is available in 10 references presenting a nice **matt finish**. This flooring is suitable for medium to high traffic areas, and facilitates floor-wall junctions, angles and welding treatments. The flooring is equipped with **Evercare™**, patented surface treatment obtained by UV laser cross-linking offering **the best chemical resistance to the main products used in healthcare** environment as Betadine, eosin, hydro alcoholic solutions, making the maintenance easy and long lasting the flooring. This treatment **avoids applying any acrylic emulsion** throughout the lifetime of the product. According to ISO 21702, **MIPOLAM COSMO** has **anti-viral activity** against Human Coronaviruses: it reduces the number of virus by 99.7% after 2h. According to ISO 22196, **MIPOLAM COSMO** has **anti-bacterial activity** against E. coli, S. aureus and MRSA of 99% after 24h. It is composed of 45% minerals, 22% of inexhaustible material and at least **25% of recycled 100% controlled**. It is free of formaldehyde, heavy metals and CMR 1 & 2 or vPvB (very persistent and very bio-accumulative) or PBT (persistent, bio-accumulative and toxic) and is **REACH compliant**. It is 100% phthalate free and 100% recyclable. VOC emissions after 28 days (ISO 16000-6) are below detection levels with <10 microgram/m<sup>3</sup> and this product is classified A + (the best class). The flooring is **antistatic** (<2kV), its residual indentation is ≤ 0.02 mm. The flooring is compliant with EN ISO 10581 norm, has a binder content type I, is suitable for heavy duty traffic areas and has a **Bfl-s1 fire** resistance.

## Mipolam Troplan

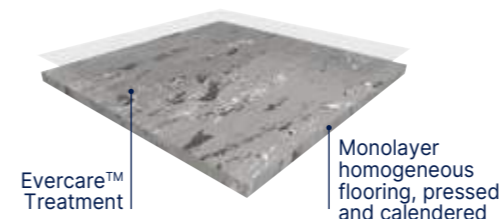

**MIPOLAM TROPLAN** is a vinyl flooring homogeneous calendered and pressed in 2 m sheets, with a thickness of 2 mm and a **weight ≤ 3300 g**. The directional design with colour throughout the thickness is available in 18 references presenting a nice **matt finish**. This flooring is suitable for medium to high traffic areas, and facilitates floor-wall junctions, angles and welding treatments. The flooring is equipped with **Evercare™**, patented surface treatment obtained by **UV laser cross-linking** offering **the best chemical resistance to the main products used in healthcare** environment as Betadine, eosin, hydro alcoholic solutions, making the maintenance easy and long lasting the flooring. This treatment **avoids applying any acrylic emulsion** throughout the lifetime of the product. According to ISO 21702, **MIPOLAM TROPLAN** has **anti-viral activity** against Human Coronaviruses: it reduces the number of virus by 99.7% after 2h. According to ISO 22196, **MIPOLAM TROPLAN** has **anti-bacterial activity** against E. coli, S. aureus and MRSA of 99% after 24h. It is composed of 45% minerals, 22% of inexhaustible material and at least **25% of recycled 100% controlled**. It is free of formaldehyde, heavy metals and CMR 1 & 2 or vPvB (very persistent and very bio-accumulative) or PBT (persistent, bio-accumulative and toxic) and is **REACH compliant**. Mipolam Troplan is 100% phthalate free and 100% recyclable. VOC emissions after 28 days (ISO 16000-6) are below detection levels with < 10 microgram/m<sup>3</sup> and this product is classified A + (the best class). The flooring is **antistatic** (< 2 kV), its residual indentation is ≤ 0.03 mm. The flooring is compliant to the EN ISO 10581 norm, has a binder content type II, is suitable for heavy duty traffic areas and has a **Bfl-s1 fire** resistance.





# Mipolam Homogeneous Evercare™

Mipolam Affinity / Accord / Cosmo / Troplan



## High performing homogeneous multipurpose floorings

Suitable for heavy traffic areas (education, healthcare, shops)

► Mipolam Affinity / Mipolam Accord / Mipolam Cosmo / Mipolam Troplan:  
Evercare™ - New revolutionary patented polyurethane surface treatment with unique performance in staining providing unrivalled chemical and scratching resistance

► Antistatic

► Densely compacted surface for improved wear and ease of maintenance

			Mipolam Affinity	Mipolam Accord	Mipolam Cosmo	Mipolam Troplan
<b>Description</b>						
Total thickness	EN ISO 24346	mm	2	2	2	2
Weight	EN ISO 23997	g/sqm	2800	2790	3000	3300
Width of sheet	EN ISO 24341	cm	200	200	200	200
Length of sheet	EN ISO 24341	lm	20	20	20	20
Tile size	EN ISO 24342	mm	608 × 608 <sup>(1)</sup>	608 × 608 <sup>(1)</sup>	608 × 608 <sup>(1)</sup>	608 × 608
Number of tiles per package	-	-	20	20	20	20
<b>Classification</b>						
Norm / Product specification	-	-	EN ISO 10581	EN ISO 10581	EN ISO 10581	EN ISO 10581
European classification	EN ISO 10874	class	34-43	34-43	34-43	34-43
Fire rating	EN 13501-1	class	Bfl-s1	Bfl-s1	Bfl-s1	Bfl-s1
Static electrical propensity	EN 1815	kV	< 2	< 2	< 2	< 2
Slip resistance	EN 16165:2021 – Appendix B (DIN 51 130)	class	R9	R9	R9	R9
<b>Performances</b>						
Type Binder content	EN ISO 10581	type	I	I	I	II
Dimensional stability (requirement)	EN ISO 23999	%	Sheet ≤ 0.40 Tile ≤ 0.25	Sheet ≤ 0.40 Tile ≤ 0.25	Sheet ≤ 0.40 Tile ≤ 0.25	Sheet ≤ 0.40 Tile ≤ 0.25
Dimensional stability (average measured value)	EN ISO 23999	%	-	-	-	-
Impact Sound Insulation	EN ISO 717-2	dB	5	5	5	4
Residual indentation (norm)	EN ISO 24343-1	mm	≤ 0.10	≤ 0.10	≤ 0.10	≤ 0.10
Residual indentation (average measured value)	-	mm	≈ 0.02	≈ 0.02	≈ 0.02	≈ 0.03
Castor chair test (type H)	ISO 4918	-	OK	OK	OK	OK
Thermal conductivity	EN ISO 10456	W/(m.k)	0.25	0.25	0.25	0.25
Colour fastness	EN ISO 105-B02	degree	≥ 6	≥ 6	≥ 6	≥ 6
Surface treatment	-	-	Evercare™	Evercare™	Evercare™	Evercare™
Chemical products resistance	EN ISO 26987	class	OK	OK	OK	OK
Anti-bacterial activity (E. coli - S. aureus - MRSA) after 24h <sup>(2)</sup>	ISO 22196	-	> 99% inhibits growth	> 99% inhibits growth	> 99% inhibits growth	> 99% inhibits growth
Anti-viral activity (human coronavirus) after 2h <sup>(2)</sup>	ISO 21702	-	> 99.7% virucidal activity	> 99.7% virucidal activity	> 99.7% virucidal activity	> 99.7% virucidal activity
<b>Environment / Indoor Air Quality</b>						
TVOC after 28 days	ISO 16000-6	microgram/m <sup>3</sup>	< 10	< 10	< 10	< 10
Certification	-	-	Floorscore®	Floorscore®	Floorscore®	Floorscore®
<b>CE Marking</b>						



EN 14041

(1) Products available in tiles for a minimum order quantity of 500 sqm.

(2) The implementation of an effective cleaning regime is the most important defence against infection.



# Mipolam Homogeneous Evercare™

Mipolam Affinity

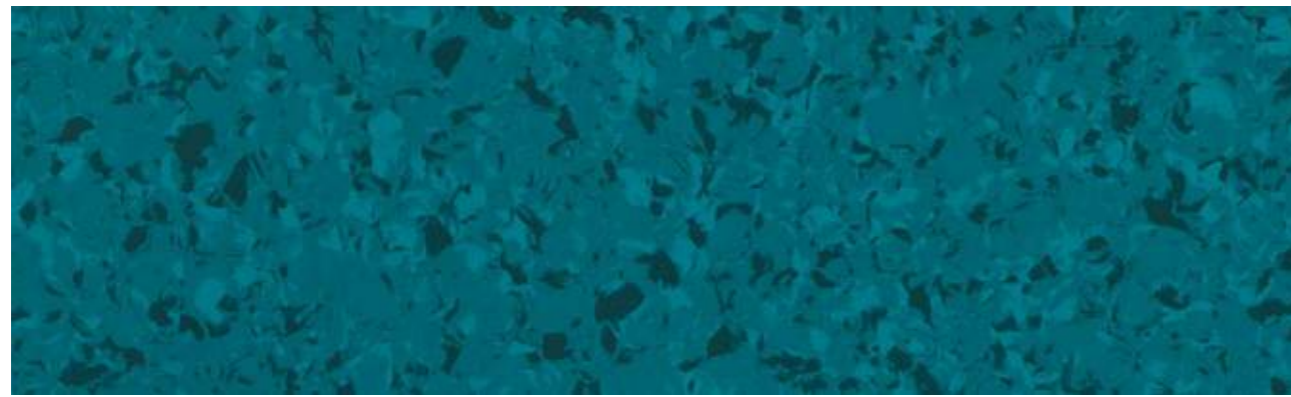
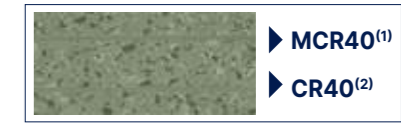

4476 Amethyst  
Ⓢ Ⓢ

^ Scale 1



4476 Amethyst - 4402 Yuki



(1) Ⓢ Mentioned colors available with MCR40 specific multicolor welding rod (code: H058)  
 (2) Ⓢ All colors available with CR40 matching uni welding rod (code: 0585)



# Mipolam Homogeneous Evercare™

Mipolam Affinity

 Compact  
 Compact  
 608 x 608 mm

Evercare™

 100% recyclable

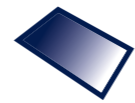

Matt finish



4402 Yuki  
 

^ Scale 1



4402 Yuki - 4447 Light Emerald

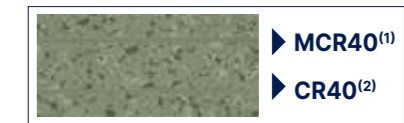

 4445 Mocca  	 4443 Lime Taupe  	 4444 Havana Brown  	 4467 Clover  
 4431 Exotic Mud  	 4463 Greige  	 4428 Sandy  	 4457 Olivine  
 4413 Marlyn  	 4441 Light Greige  	 4404 Milkshake  	 4427 Pine Forest  
 4412 Tundra  	 4405 Sand Opal  	 4424 Smoked Opal  	 4407 Spearmint  
 4411 Raffia  	 4401 Quartz  	 4403 Natural Shade  	 4447 Light Emerald  
		 4432 Citrine  	 4422 Mango  

(1)  Mentioned colors available with MCR40 specific multicolor welding rod (code: H058)  
 (2) All colors available with CR40 matching uni welding rod (code: 0585)



# Mipolam Homogeneous Evercare™

## Mipolam Accord

 Compact  
 Compact  
 608 × 608 mm

Evercare™

 100% recyclable

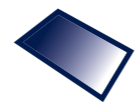

Matt finish

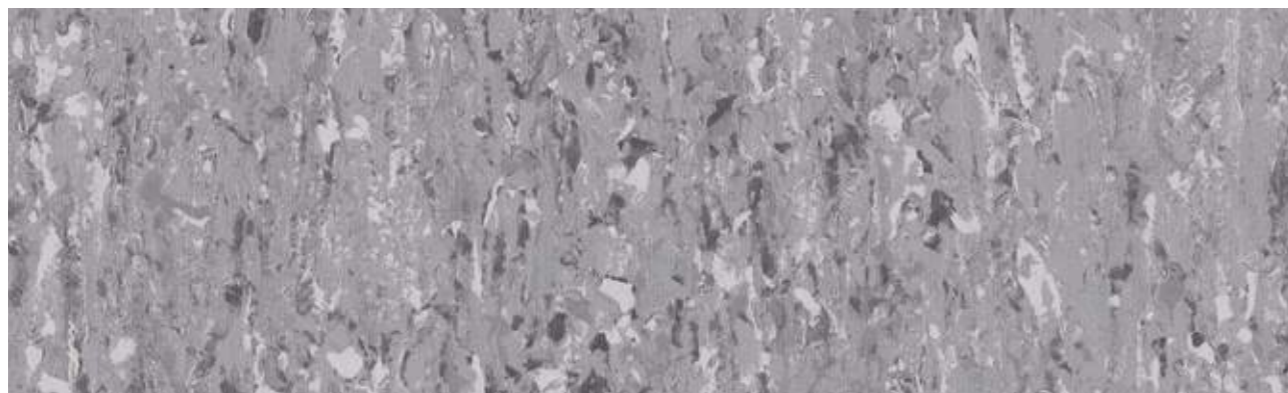

0330 Kruger



^ Scale 1



0330 Kruger / 0321 Salt

 0321 Salt  	 0301 Louise  	 0305 Light Sand  	 0332 Dore  
 0312 Powell  	 0303 Manitoba  	 0324 Sand  	 0447 Grunsee  
 0310 Huron  	 0319 Toba  	 0441 Loch Ness  	 0315 Orange River  
 0306 Inari  	 0320 Ontario  	 0463 Bourget  	
 0316 Malaren  	 0450 Thames  	 0443 Krumme  	
 0346 Roxen  	 0360 Balaton  	 0459 Mississippi  	



# Mipolam Homogeneous Evercare™

## Mipolam Cosmo

 Compact  
 Compact  
 608 × 608 mm

**Evercare™**
 100% recyclable

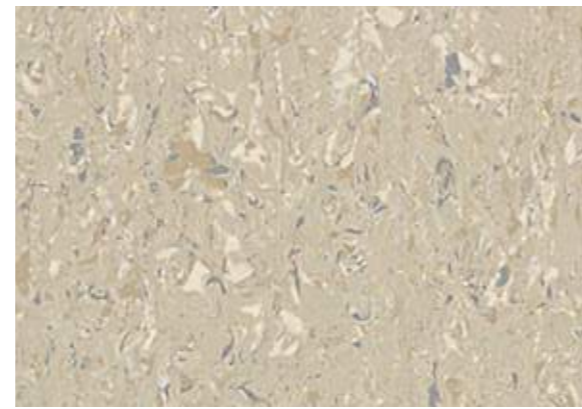

2633 Lichen ^ Scale 1

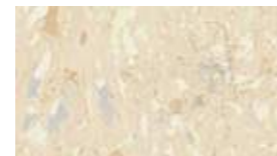

2603 Lemon Chiffon



2317 Soft Green



2609 Light Smoke



2606 Azur



2610 Silver



2636 Overseas



2638 Pure Grey



2355 Real Red



2639 Smart Grey



## Mipolam Troplan

 Compact  
 Compact  
 608 × 608 mm

**Evercare™**
 100% recyclable



1004 Earth ^ Scale 1



1009 Light Grey



1032 Yellow



1055 Apricot



1002 Beige

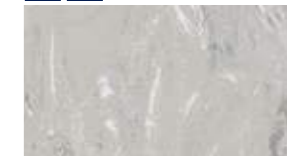

1010 Grey



1006 Blue



1007 Green



1003 Light Ocre



1059 Blue Grey



1036 Medium Blue



1037 Medium Green



1035 Ocre



1040 Dark Grey



1056 Dark Blue



1057 Dark Green



1033 Brown



1060 Anthracite





# Mipolam Homogeneous PUR

## Mipolam Classic

### Mipolam Classic

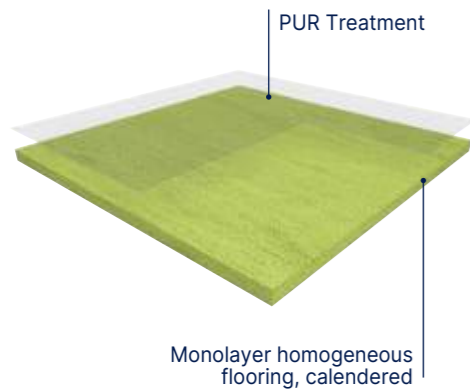

**MIPOLAM CLASSIC 1.5 mm** is a flexible homogeneous calendared compacted floorcovering in tiles or sheets, with directional design, colour dyed as a raw mixture to ensure even colour throughout the thickness of 1.5 mm and a **weight of ≤ 2520 g**. Its surface is densely compacted for improved wear and ease of maintenance.

It receives a polyurethane (**PUR**) surface treatment for ease of maintenance and to avoid the use of an immediate acrylic emulsion after installation. The flooring complies with the **EN ISO 10874** (34-43) and EN ISO 10581, has a binder content type II, has Bfl-s1 fire resistance. It is suitable for heavy traffic areas.

It is 100% recyclable. Its VOC emissions after 28 days (ISO 16000-6) are below detection levels (< 10 microgram/m<sup>3</sup>) and this product is classified A + (the best class).

**MIPOLAM CLASSIC 2 mm** is a flexible homogeneous calendared compacted floorcovering in tiles or in 2 m sheets, with a thickness of 2 mm and a **weight of ≤ 3300 g**. This directional design, colour dyed as a raw mixture to ensure even colour throughout the thickness is available in 14 references. Its surface is densely compacted for improved wear and ease of maintenance.

It receives a polyurethane (**PUR**) surface treatment for ease of maintenance and to avoid the use of an immediate acrylic emulsion after installation. The flooring complies with the **EN ISO 10874** (34-43) and EN ISO 10581, has a binder content type II, has Bfl-s1 fire resistance. It is suitable for heavy traffic areas.

It is 100% recyclable. Its VOC emissions after 28 days (ISO 16000-6) are below detection levels (< 10 microgram/m<sup>3</sup>) and this product is classified A + (the best class).

#### Mipolam Classic

Description				
Total thickness	EN ISO 24346	mm	1.5	2
Weight	EN ISO 23997	g/sqm	2520	3300
Width of sheet	EN ISO 24341	cm	200	200
Length of sheet	EN ISO 24341	lm	20	20
Tile size	EN ISO 24342	mm	-	300 × 300 <sup>(1)</sup> / 608 × 608
Number of tiles per package	-	-	-	50 / 20
Classification				
Norm / Product specification	-	-	EN ISO 10581	EN ISO 10581
European classification	EN ISO 10874	class	23-31	34-43
Fire rating	EN 13501-1	class	Bfl-s1	Bfl-s1
Static electrical propensity	EN 1815	kV	< 2	< 2
Performances				
Type Binder content	EN ISO 10581	type	II	II
Dimensional stability	EN ISO 23999	%	≤ 0.40	Sheet ≤ 0.40 / Tile ≤ 0.25
Impact Sound Insulation	EN ISO 717-2	dB	-	4
Residual indentation (norm)	EN ISO 24343-1	mm	≤ 0.10	≤ 0.10
Residual indentation (average measured value)	-	mm	≈ 0.03	≈ 0.03
Castor chair test (type H)	ISO 4918	-	OK	OK
Thermal conductivity	EN ISO 10456	W/(m.k)	0.25	0.25
Colour fastness	EN ISO 105-B02	degree	≥ 6	≥ 6
Surface treatment	-	-	PUR	PUR
Chemical products resistance	EN ISO 26987	class	OK	OK
Environment / Indoor Air Quality				
TVOC after 28 days	ISO 16000-6	microgram/m <sup>3</sup>	< 10	
Certification	-	-	Floorscore®	
CE Marking				



EN 14041



(1) Tiles (300 × 300 mm) available for a minimum order quantity of 500 sqm.



0002 Platinum ▲

^ Scale 1



0108 Pepper



0122 Pineapple



0123 Corallo

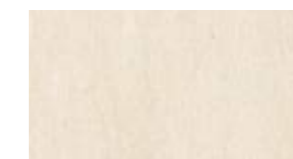

0301 Beige



0005 Steel ▲



0010 Azure



0121 Green Leaf



0003 Ivory



0303 Grey



0013 Pewter



0124 Tortora



0014 Brown



0125 Truffle



All colours available as 300 × 300mm tiles upon request for a minimum order quantity of 500 sqm.  
▲ Thickness: 1.5 mm - Sheet format only



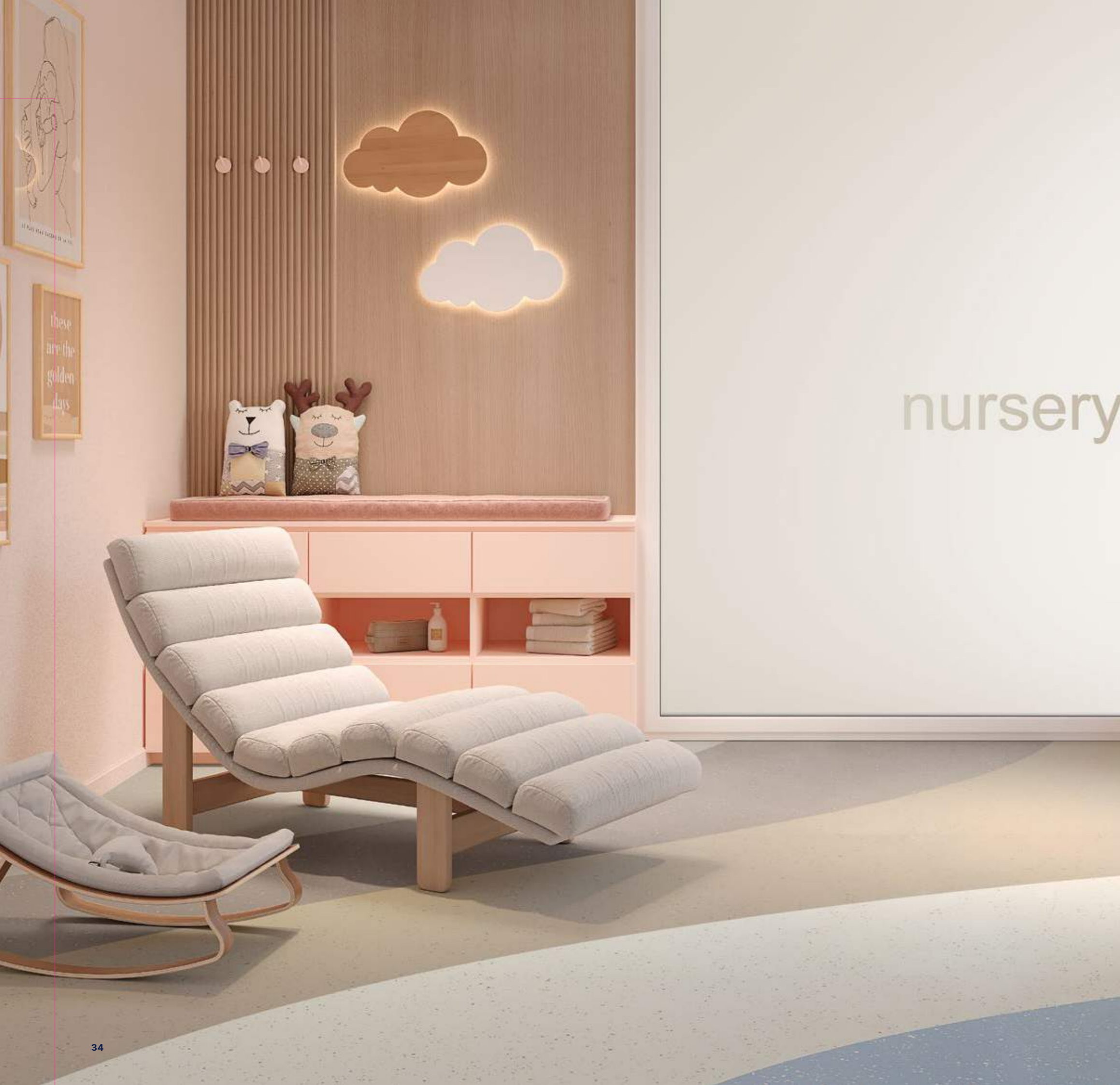

## Premium

pages 34-53

nursery

### 34. Premium **New**

- 40. Poesy
- 42. Neopolis
- 43. Metallica
- 44. Osmoz
- 46. Indiana
- 48. Brazilia
- 50. Cocoon
- 51. Neoterra

### 52. Premium ZERO **New**

# Premium

New collection

## More sustainable materials

# 80%

### Biocontent, Mineral & Recycled

Premium contains 20% crop residues from responsible sources. We recycle discarded soy waste from the animal feed industry. The result: less fossil based material and less carbon.

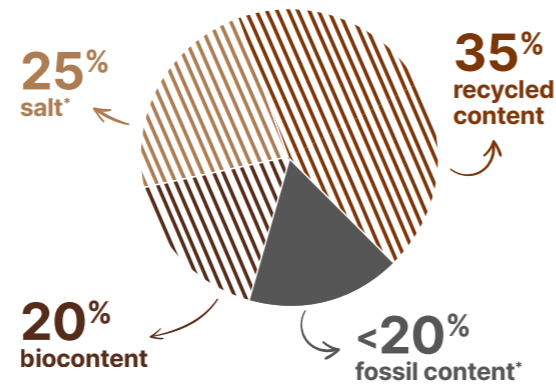

## Low carbon solution



Thanks to its improved composition, Premium emits 29%\*\* less CO<sub>2</sub> than the average heterogeneous floorings.

**A good choice to decarbonise your projects.**

\* Vinyl is made of two main ingredients : ethylen and salt.  
\*\* Based on life cycle assessment certified by UL for an average heterogeneous product.



## To go a step forwards Premium Zero

### Towards a world with 0 fossil extraction

More than 95% of natural, recycled and bio-attributed content. Available on demand.

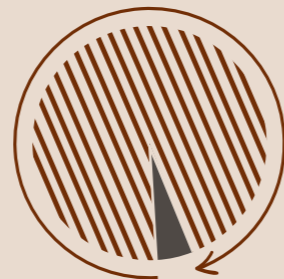

# Premium in performances

35 years of satisfied customers



## Unrivalled durability

- High density pressed wearlayer
- Pressed under 800 tons
- Immutables designs



## High resistance to heavy loads

- Double reinforcement for excellent dimensional stability
- Easy rolling

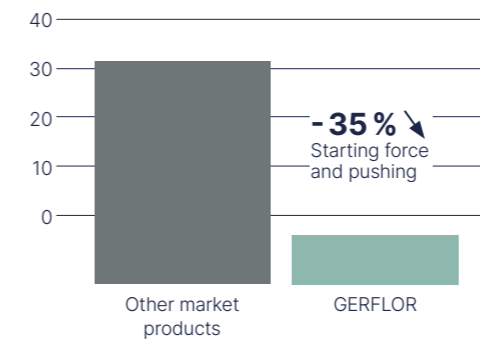

## Lower maintenance costs

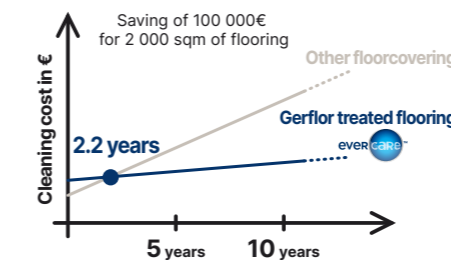

## Indoor air quality

- A+ / Floorscore / M1 certified
- Phthalate-free
- Anti-bacterial activity: ISO 22196

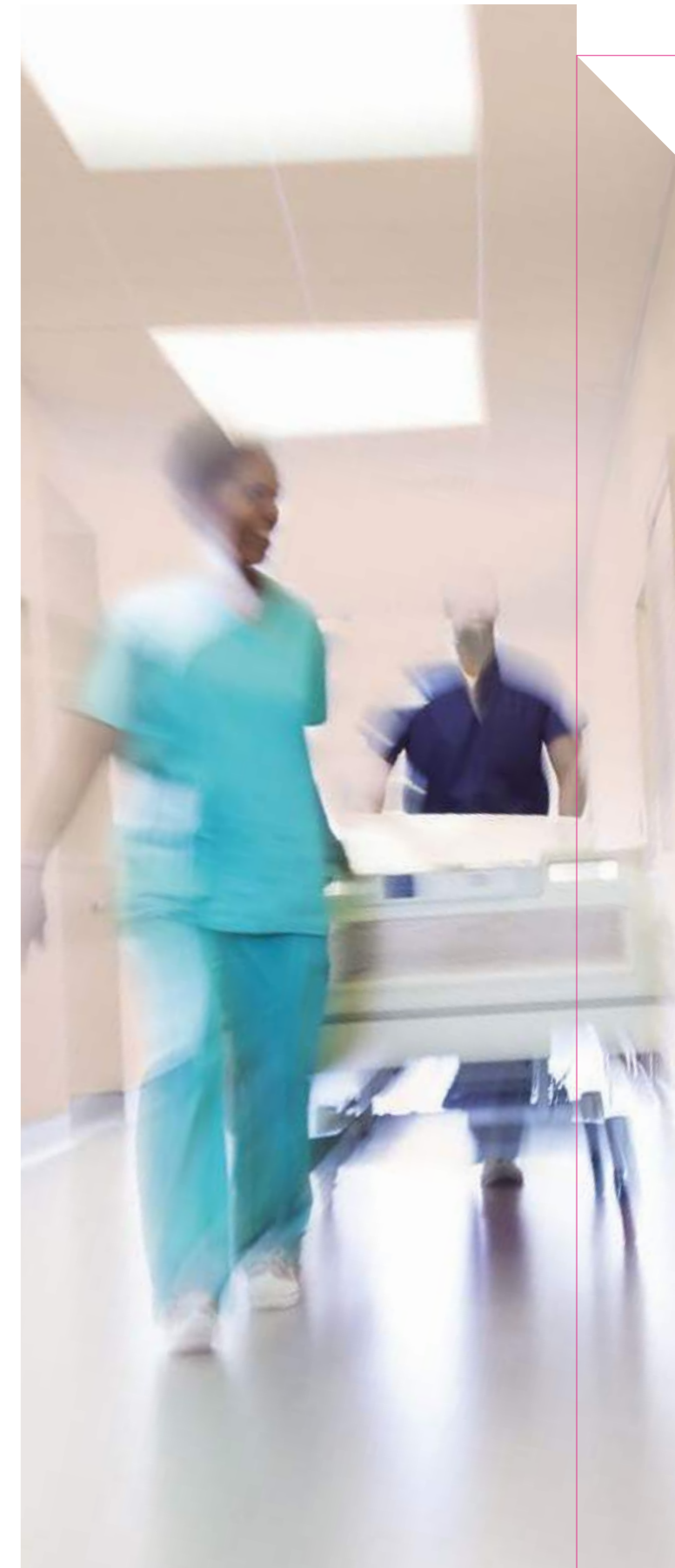



## Premium Acoustic

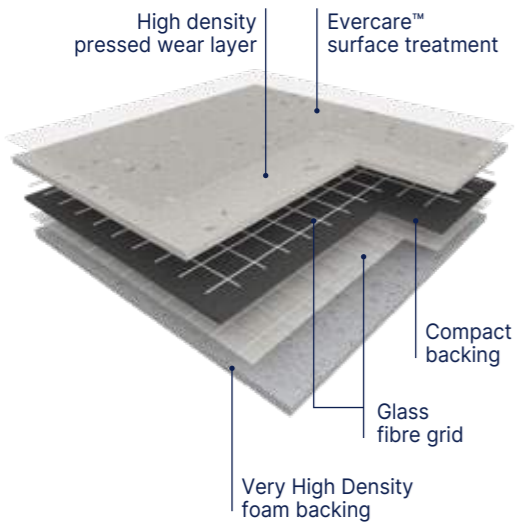

The floor covering is made of a **>1mm thick, pure vinyl homogeneous wear layer with no filler, incorporating very densely pressed coloured chips, with a mat finishing and without a transparent wear layer.**

It offers a T group wear rating and is available in 2 m wide sheet. The product contains a compact backing which is calendared, pressed and a Very High Density (VHD) foam backing. It is reinforced with a double glass fibre grid.

It offers a **16 dB sound insulation, an indentation resistance of 0.06 mm and a rolling heavy loads easiness.**

**PREMIUM COMFORT** is treated with **Evercare™**, a surface treatment obtained by UV laser crosslinking. It ensures easy maintenance and eliminates permanently the need for acrylic emulsion (metallisation). It avoids staining of chemical products used in healthcare like iodine alcohol, Betadine, eosin and anti-bacterial hand gel.

According to ISO 21702, **PREMIUM COMFORT** has **anti viral activity** against Human Coronaviruses : it reduces the number of virus by 99,7% after 2h00. According to ISO 22196, it has **anti bacterial activity** against E. coli, S. aureus and MRSA of 99% after 24h00.

It is 100% compliant with REACH. It is composed of 40% of minerals and inexhaustible materials. It is made with more than 50% recycled content; 100% of which are fully controlled and REACH compliant. It does not contain any heavy metals, any formaldehydes and it is made with phthalate free plasticizers. The products emission rate of volatile organic compounds is **<10µg/m³ (TVOC after 28 days – ISO 16000-6)**. It is 100% recyclable.

## Premium Compact

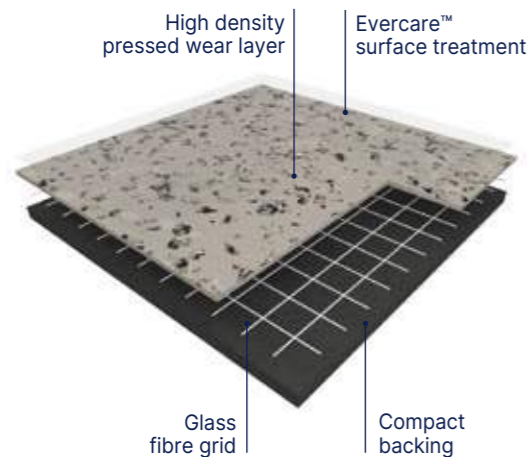

Our **PREMIUM COMPACT** is made of a **>1mm thick, pure inlaid wearlayer pressed under 800 tonnes with no filler, incorporating very densely pressed coloured chips, with a mat finishing and without a transparent wear layer.** It offers a T group wear rating and is available in 2 m wide sheet. Its compact backing is calendared, pressed and reinforced with a fiber grid yielding. It offers a **8 dB sound insulation, an indentation resistance of 0.02 mm and a rolling heavy loads easiness.**

**PREMIUM COMPACT** is treated with **Evercare™**, patented surface treatment obtained by UV laser cross-linking offering the best chemical resistance to the main products used in healthcare environment as betadine, eosin, hydro alcoholic solutions, making the maintenance easy and the floor long lasting. This treatment avoids applying any acrylic emulsion throughout the lifetime of the product.

According to ISO 21702, **PREMIUM COMPACT** has **anti viral activity** against Human Coronaviruses : it reduces the number of virus by 99,7% after 2h00.

According to ISO 22196, it has **anti bacterial activity** against E. coli, S. aureus and MRSA of 99% after 24h00.

It is composed of : 42% of recycled content / 19% of bio-sourced raw material (from agricultural vegetal waste) / 56% of mineral raw material ; 100% of which are fully controlled and REACH compliant.

It is free of formaldehyde, heavy metals and CMR 1 & 2 or vPvB (very persistent and very bio accumulative) or PBT (persistent, bio-accumulative and toxic) and is 100% REACH compliant. **Its VOC emissions after 28 days (ISO 16000-6) are below detection levels (<10 µg / m³) and this product is classified A + (the best class) and Floorscore® & M1 certified for indoor air quality.** **PREMIUM COMPACT** has antibacterial efficacy (E.coli / S.aureus / MRSA) : >99% after 24 hours according to ISO22196.

**PREMIUM COMPACT is made in France, is 100% recyclable, and the floorcovering will have its individual EPD sheet** (number 4790130460.106.2).



### • Outstanding durability

Design within the whole thickness of the wear layer,  $\geq 1.02$  mm thick

### • Long lasting appearance

Pure vinyl wear layer (no filler, no transparent wear layer) for the best scratch and soiling resistance

### • Easy maintenance & matt effect

Evercare™ surface treatment

### • Excellent indoor air quality

TVOC after 28 days < 10 microgram/m³

### • Rolling heavy loads easiness, best stability and very high performance indentation / acoustic 0.06 mm / 17 dB (Metallica: 16 dB) for Comfort, 0.02 mm / 8 db for Compact Glass fibre grid reinforcement & very high density foam backing

Description	Premium Acoustic		Premium Compact	
	Brazilia / Indiana / Cocoon / Neopolis / Osmoz / Poesy / Neoterra - Metallica		Brazilia / Indiana / Cocoon / Neopolis / Osmoz / Poesy / Neoterra - Metallica	
Total thickness	EN ISO 24346	mm	3.00 - 3.30	2.00
Thickness of wearlayer	EN ISO 24340	mm	$\geq 1.02$	$\geq 1.02$
Weight	EN ISO 23997	g/sqm	$\geq 2800$	2580 - 2620
Width of sheet	EN ISO 24341	cm	200	200
Length of sheet	EN ISO 24341	lm	25	20
<b>Classification</b>				
Norm / Product specification	-	-	EN ISO 11638	EN ISO 10582
European classification	EN ISO 10874	class	34-42	34-43
Fire rating	EN 13501-1	class	Cfl-s1	Bfl-s1
Static electrical propensity	EN 1815	kV	< 2	< 2
Slip resistance	EN 16165:2021 – Appendix B (DIN 51 130)	class	R10	R10
<b>Performances</b>				
Wear resistance	EN 660.2	mm³	$\leq 2.0$	$\leq 2.0$
Wear group	-	group	T	T
Type Binder content	EN ISO 10582	type	-	I
Dimensional stability	EN ISO 23999	%	$\leq 0.40$	$\leq 0.40$
Residual indentation (requirement)	EN ISO 24343-1	mm	$\leq 0.20$	$\leq 0.10$
Residual indentation (average measured value)	-	mm	$\approx 0.06$	$\approx 0.02$
Impact sound insulation	EN ISO 717-2	dB	17 16 (Metallica)	8
Castor chair test (type H)	ISO 4918	-	OK	OK
Thermal conductivity	EN ISO 10456	W/(m.k)	0.25	0.25
Colour fastness	EN ISO 105-B02	degree	$\geq 6$	$\geq 6$
Surface treatment	-	-	Evercare™	Evercare™
Chemical products resistance <sup>(1)</sup>	EN ISO 26987	-	OK	OK
Anti-bacterial activity (E. coli - S. aureus - MRSA) after 24h <sup>(2)</sup>	ISO 22196	-	> 99% inhibits growth	> 99% inhibits growth
Anti-viral activity (human coronavirus) after 2h <sup>(2)</sup>	ISO 21702	-	> 99.7% virucidal activity	> 99.7% virucidal activity
<b>Environment / indoor air quality</b>				
TVOC after 28 days	ISO 16000-6	microgram/m³	< 10	< 10
Certification	-	-	Floorscore®	Floorscore®
<b>CE marking</b>				



EN 14041



(1) Regarding the resistance to chemicals, please download the corresponding leaflet from our website.  
(2) The implementation of an effective cleaning regime is the most important defence against infection.





# Premium New

## Poesy

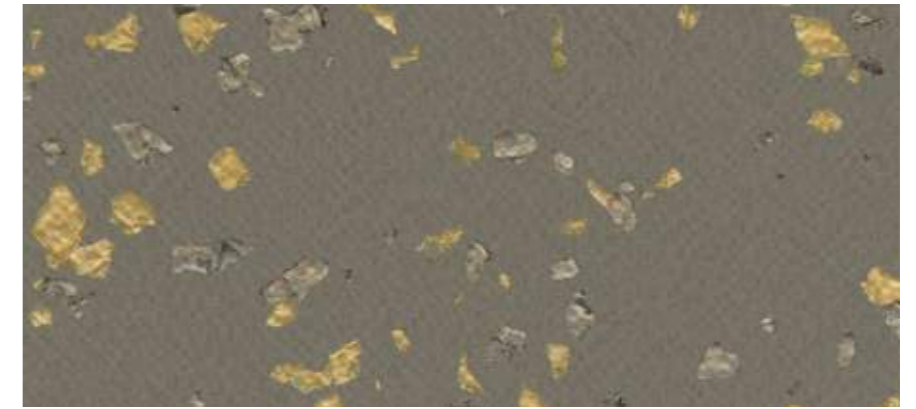
Compact Acoustic 17 dB VHD Evercare™ 100% recyclable



2749 Lyrique  
 

^ Scale 1

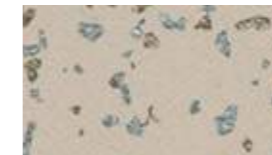



2747 Ballade  
 



2151 Sonate  





8621 Ode  
 



2750 Ellipse  
 

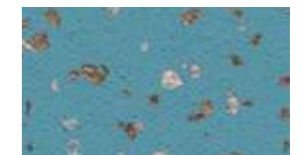

2152 Octave  
 



8627 Allegorie  



2751 Slam  



2748 Refrain  



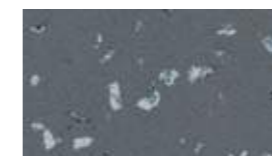

2501 Rhapsody  
 



2752 Litote  
 



8626 Rime  
 

POESY 2749 Lyrique / METALLICA 8257 Nyx



# Premium **New**

## Neopolis

Compact Acoustic 17 dB VHD Evercare™ 100% recyclable



2743 Central Park



2743 Central Park ^ Scale 1



2744 Queens Soft



2745 Plaza



2741 Brooklyn

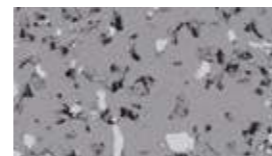

2740 Harlem Soft



2742 Times Square

## Metallica

Compact Acoustic 16 dB VHD Evercare™ 100% recyclable



0062 Beyla



0062 Beyla ^ Scale 1



0061 Eldir



0060 Dellig



9753 Energy



9745 Cosmic



0064 Sudri



0063 Narfi



8257 Nyx



2746 Ymir



# Premium New

## Osmoz

 Compact
  Acoustic
  17 dB
  VHD
  Evercare™
  100% recyclable



4364 Ivory  
 

^ Scale 1



4378 Igloo  





4349 Angora  
 

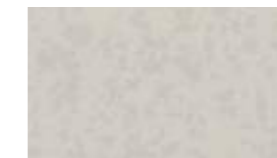

4379 Koudou  

4365 Alpaga  
 



4380 Awara  





4384 Barbadine  



3792 Storm Grey  



4381 Rozelle  



4383 Jasmin  



3791 Slate Grey  
 



4351 Greige  



4382 Cyclades  
 



7737 Pepper Grey  



4364 Ivory / 4379 Koudou



# Premium New

## Indiana

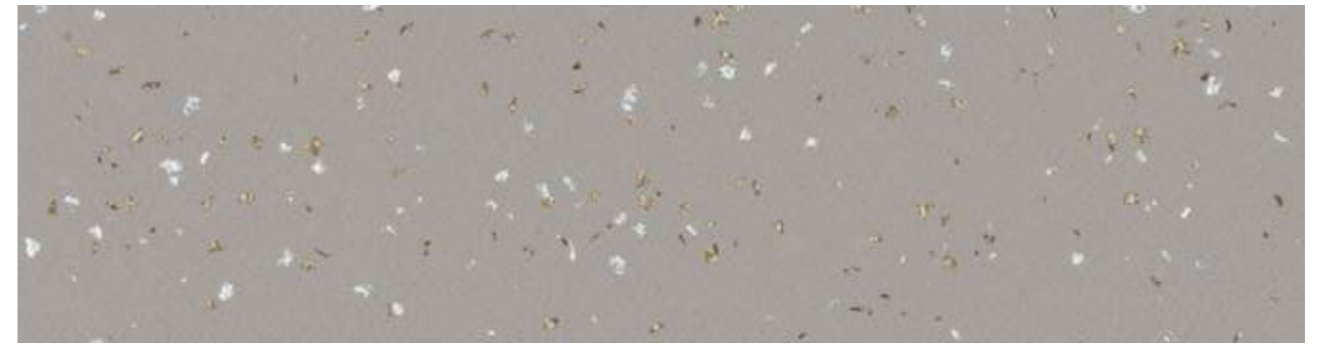
Compact Acoustic 17 dB VHD Evercare™ 100% recyclable



8226 Fidji  
Ⓞ Ⓞ

^ Scale 1



8150 Bali  
Ⓞ



4048 Malabo  
Ⓞ



4045 Dalupiri  
Ⓞ



4001 Ofu  
Ⓞ Ⓞ



4343 Tokelau  
Ⓞ Ⓞ



4049 Kilmia  
Ⓞ



7517 Faroe  
Ⓞ



4009 Tufoa  
Ⓞ Ⓞ



4052 Calero  
Ⓞ Ⓞ



4050 Comores  
Ⓞ



4047 Okuza  
Ⓞ Ⓞ



4002 Manua  
Ⓞ Ⓞ



4053 Diwaran  
Ⓞ Ⓞ



4051 Maraca  
Ⓞ



4476 Wattaru  
Ⓞ



4046 Cubagua  
Ⓞ



8837 Songo  
Ⓞ



4003 Tao  
Ⓞ



# Premium New

## Brazilia

Compact Acoustic 17 dB VHD Evercare™ 100% recyclable



8386 Boa Vista  
Ⓢ Ⓢ

^ Scale 1



0053 Limeira  
Ⓢ

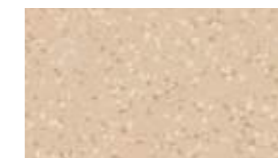

0051 Alvorada  
Ⓢ Ⓢ



0052 Olinda  
Ⓢ



0056 Natal  
Ⓢ



8736 Recife  
Ⓢ Ⓢ



0054 Barueri  
Ⓢ



4477 Maceio  
Ⓢ

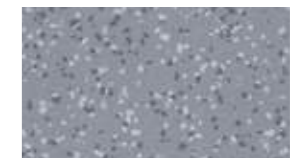

3709 Ceara  
Ⓢ



0055 Teresina  
Ⓢ



0058 Aracaju  
Ⓢ



3707 Paraiba  
Ⓢ

0058 Aracaju / 8386 Boa Vista / 0054 Barueri



# Premium New

## Cocoon

Compact Acoustic 17 dB VHD Evercare™ 100% recyclable

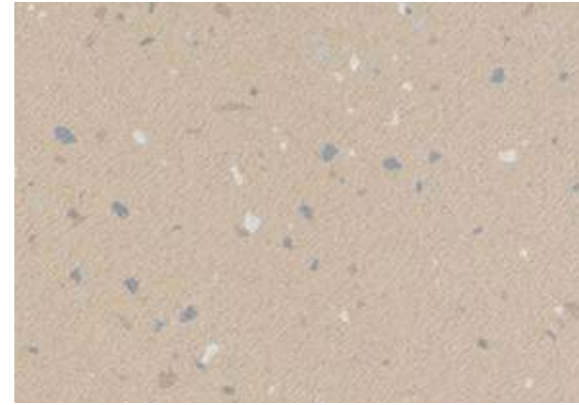

0032 Satin ^ Scale 1  
⓪ ⓪



0030 Crinolin  
⓪



0027 Muslin  
⓪ ⓪



0029 Flannel  
⓪



0028 Organza  
⓪

0032 Satin / 0030 Crinolin /  
0027 Muslin / 0028 Organza

## Neoterra

Compact Acoustic 17 dB VHD Evercare™ 100% recyclable



4208 Dorata ^ Scale 1  
⓪ ⓪



4207 Prato  
⓪

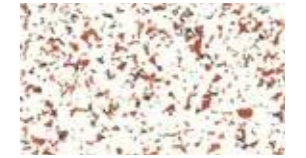

4208 Soraya  
⓪



4206 Lazuli  
⓪ ⓪

NEOTERRA 4208 Dorata / INDIANA 4052 Calero



# Premium ZERO New

Facing the urgent challenges of climate change and resource scarcity, we are committed to reducing the environmental impact of our products.

Together, let's build a more sustainable future, one step at a time.

**we care / we act**

## Towards ZERO carbon

The innovative Premium ZERO formula further strengthens our commitment to reducing carbon footprints and supports your projects where very low carbon materials are required.

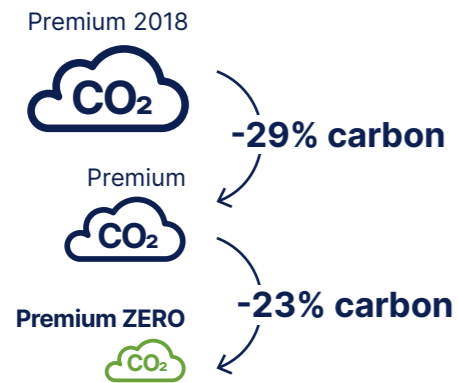

Thanks to its pioneering composition, Premium ZERO Compact carbon footprint is only 4kg eq CO<sub>2</sub>/sqm (based on 1 year life cycle) and 7kg eq CO<sub>2</sub>/sqm (based on 25 years life cycle)



EPD available certified by UL.

**Product available on demand.**

For more information, please contact your Gerflor representative

# Towards ZERO fossil extraction

Premium ZERO is a new generation of flooring that's leading the way towards using zero virgin ingredients and achieving zero fossil extraction.

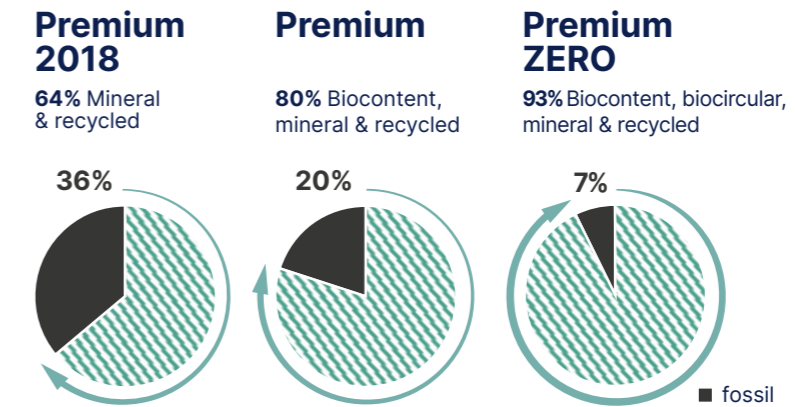

## Inside Premium ZERO: one step further



### Biocontent

Ingredients made from soy residues, turning agricultural waste into a valuable resource that ensures product flexibility.



### Biocircular

Vinyl made from renewable sources like used cooking oil, reducing reliance on fossil fuels while maintaining quality. Third-party certified (ISCC Plus) according to a mass balance approach.

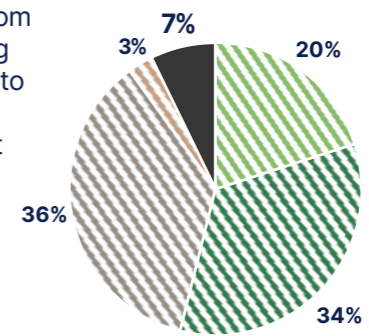

■ biocontent ■ biocircular ■ recycled ■ mineral

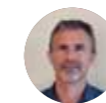

"All Gerflor product ranges are designed according to a life cycle analysis model. This model shows that raw materials and product composition represent around 50% of a product's CO<sub>2</sub> footprint based on a 25 years life cycle. In this context, Premium ZERO has a pioneering formula designed to minimise fossil raw material extraction and maximise bio, mineral and recycled content"

Innovation & Sustainability Director





# Taralay Multilayered

pages 54-123

## 58. Taralay Millenium

60. Cosmic  
62. Stellar

## 64. Taralay Libertex

68. Wood  
70. Amsterdam  
70. Paros  
71. Reflect

## 72. Taralay Impression Taralay Impression hop

78. Wood  
84. Cemento  
84. Terrazzo  
85. Rough  
85. Riverside  
86. Gentlemen  
86. Pure Wool  
87. Finesse  
88. Envol  
88. Jungle  
89. Nido  
89. Rice  
91. FlipKubes  
91. Kubes  
92. Metallic  
92. Nest  
93. Chess  
94. Happy  
96. Uni Matt

## 98. My Taralay Impression

## 102. Taralay Initial

104. Wood  
108. Urban  
108. Strada  
109. Spider  
110. Diversion  
111. Miami

## 112. Nerok

114. Nerok 55  
114. Nerok 70

## 120. Tarastep Pro



# Taralay Multilayered

**Premium**  
See pages 34/53

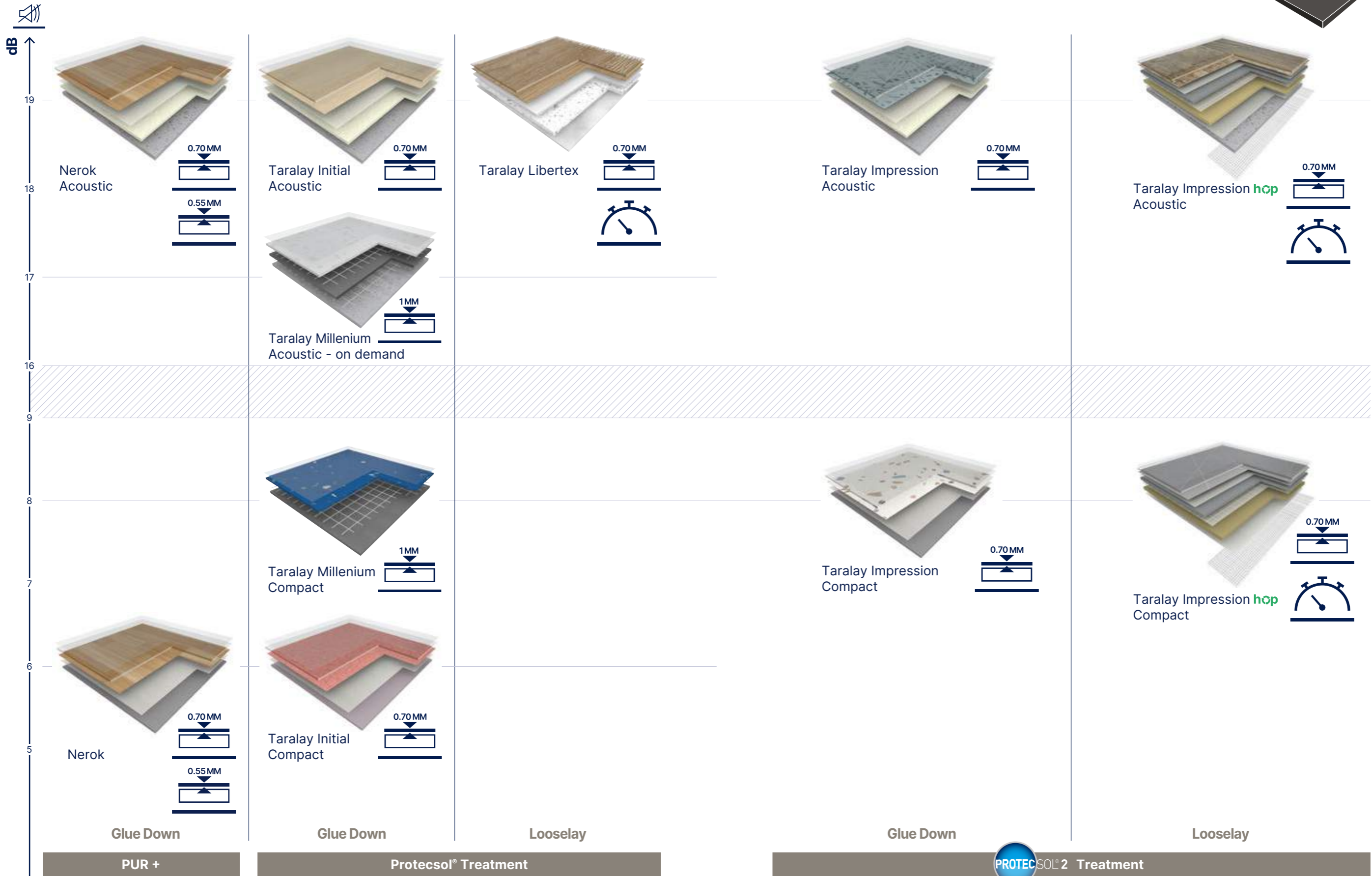



# Taralay Multilayered

## Taralay Millenium

### Taralay Millenium Compact

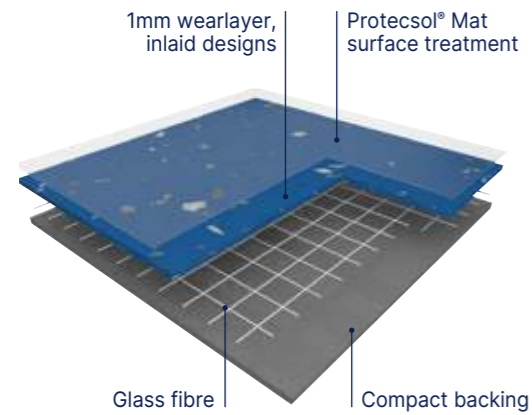

**TARALAY MILLENIUM COMPACT** is a multilayered vinyl floor covering available in 2m wide sheet, with a group T wear rating. The product comprises a **1 mm thick coated wear layer, made of pure vinyl, coloured throughout its thickness (no transparent wear layer and no filler)**. Its complete thickness is 2 mm. It is reinforced with a fibre glass grid for a better dimensional stability. The construction of the product yields a 8dB sound insulation rating and a **resistance to indentation of 0.03 mm**.

This flooring is protected by the surface treatment, **ProtecSol® Mat**, with a minimum thickness of 13µm, ensuring easy maintenance and no required polish for the entire lifetime of the product.

It is composed of 50% mineral and inexhaustible materials. It does not contain any heavy metals or CMR 1&2 components and it is 100% compliant with REACH. The product emission rate of volatile organic compounds is <10 micrograms/m<sup>3</sup> (TVOC after 28 days ISO 16000-6).

It is 100% recyclable.

### Taralay Millenium Acoustic (on demand)

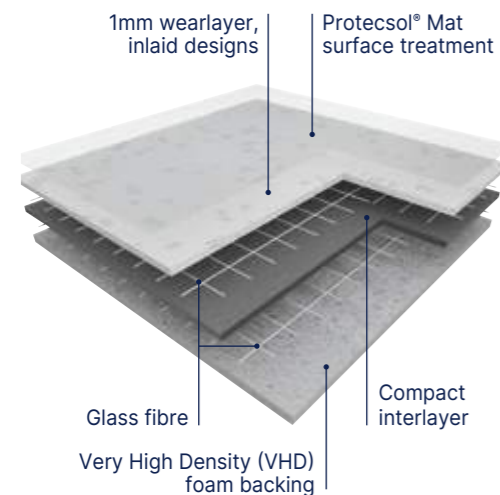

**TARALAY MILLENIUM ACOUSTIC** is a multilayered vinyl floorcovering available in 2m wide sheet, with a group T wear rating. The product comprises a **1 mm thick coated wear layer, made of pure vinyl, coloured throughout its thickness (no transparent wear layer and no filler)**. Its complete thickness is 3.4 mm. It contains a Very High Density (VHD) foam backing and is reinforced with 2 fibre glass grids which yields a **17dB sound insulation** rating and a **resistance to indentation of 0.07 mm**.

This flooring is protected by the surface treatment, **ProtecSol® Mat**, with a minimum thickness of 13µm, ensuring easy maintenance and no required polish for the entire lifetime of the product.

It is composed of 50% mineral and inexhaustible materials. It does not contain any heavy metals or CMR 1&2 components and it is 100% compliant with REACH. The product emission rate of volatile organic compounds is <10 micrograms/m<sup>3</sup> (TVOC after 28 days ISO 16000-6).

It is 100% recyclable.



- **Design within the whole thickness – no filler**  
Outstanding abrasion resistance
- **Very high density (VHD) foam backing**  
Easy rolling for loads
- **ProtecSol® Mat Surface Treatment**  
Easy cleaning
- **100 % Recyclable**  
Eco-responsible solutions

			Taralay Millenium Compact	Taralay Millenium Acoustic*
<b>Description</b>				
Total thickness	EN ISO 24346	mm	2.00	3.40
Thickness of wearlayer	EN ISO 24340	mm	1	1
Weight	EN ISO 23997	g/sqm	2725	3385
Width of sheet	EN ISO 24341	cm	200	200
Length of sheet	EN ISO 24341	lm	20	25
<b>Classification</b>				
Norm / Product specification	-	-	EN ISO 10582	ISO 11638 (EN 651)
European classification	EN ISO 10874	class	34-43	34-42
Fire rating	EN 13501-1	class	Bfl-s1	Cfl-s1
Static electrical propensity	EN 1815	kV	< 2	< 2
Slip resistance wet	EN 16165:2021 – Appendix B (DIN 51 130)	class	R10	R10
<b>Performances</b>				
Wear resistance	EN 660.2	mm <sup>3</sup>	≤ 2.0	≤ 2.0
Wear group	-	group	T	T
Type Binder content	EN ISO 10582	type	I	-
Dimensional stability	EN ISO 23999	%	≤ 0.40	≤ 0.40
Residual indentation (requirement)	EN ISO 24343-1	mm	≤ 0.10	≤ 0.20
Residual indentation (average measured value)	-	mm	≈ 0.03	0,07
Impact sound insulation	EN ISO 717-2	dB	8	17
Castor chair test (type H)	ISO 4918	-	OK	OK
Thermal conductivity	EN ISO 10456	W/(m.k)	0.25	0.25
Colour fastness	EN ISO 105-B02	degree	≥ 6	≥ 6
Surface treatment	-	-	ProtecSol® Mat	ProtecSol® Mat
Chemical products resistance	EN ISO 26987	-	OK	OK
Anti-bacterial activity (E. coli - S. aureus - MRSA) <sup>(1)</sup>	ISO 22196	-	> 99% inhibits growth	> 99% inhibits growth
Anti-viral activity (human coronavirus) after 2h <sup>(1)</sup>	ISO 21702	-	> 99.3% virucidal activity	> 99.3% virucidal activity
<b>Environment / indoor air quality</b>				
TVOC after 28 days	ISO 16000-6	microgram/m <sup>3</sup>	< 10	< 10
Certification	-	-	Floorscore®	Floorscore®
<b>CE marking</b>				



EN 14041



(1) The implementation of an effective cleaning regime is the most important defence against infection.  
\*available on demand (minimum order quantity : 1000 sqm)



# Taralay Multilayered

Taralay Millenium - Cosmic

 Compact
  Acoustic\*
 17 dB
  VHD
  Protacosol® Mat
  100% recyclable

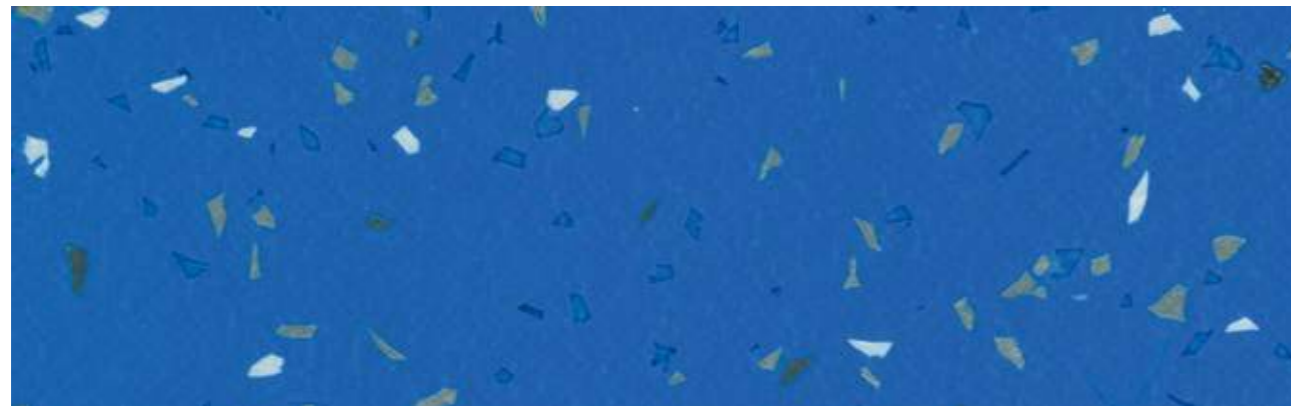

5718 Pallas  

^ Scale 1



Pallas



8856 Pandore  



4038 Delia  



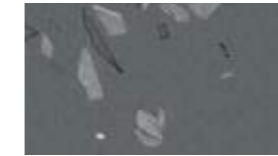

4161 Hilda  





5728 Ilias  

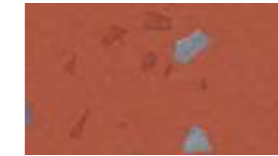



4369 Egeria  

4160 Hermione  



5723 Lotis  



4036 Vesta  





4159 Kalliope  





5721 Fortuna  



4368 Astree  

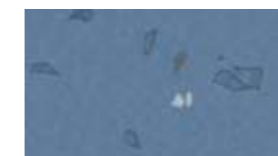

8645 Bianca  





3442 Doris  



4037 Gyptis  



4374 Aria  





3438 Iris  





4533 Ceres  





4532 Sylvia  



4162 Adonis  



3435 Nemesis  



4531 Camilla  

\*Acoustic: available on demand (minimum order quantity : 1000 sqm)



# Taralay Multilayered

Taralay Millenium - Stellar



 17 dB
 
 ProtecSol® Mat
 
 100% recyclable



4163 Flore ^ Scale 1  





3446 Eden  



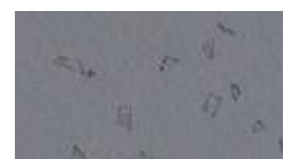

4039 Pan  

5724 Chicago  



4200 Apolon  



4373 Fudo  



4372 Boree  



4164 Eros  



3439 Europa  



5726 Yuna  



5725 Freia  

\*Acoustic: available on demand (minimum order quantity : 1000 sqm)



# Taralay Multilayered - fast track installation

Taralay Libertex

## All Taralay benefits...



**Hygienic & easy maintenance**  
Protecsol® surface treatment



**Comfort**  
Max<sup>3</sup> Layer system



**High traffic resistance**  
0.7 mm wearlayer

34

## ... with fast track installation



**Minimal subfloor preparation**  
Installation on existing or uneven subfloors



**No dry time**  
Looselay solution



**No shutdown**  
No odor, no glue, minimum facility downtime

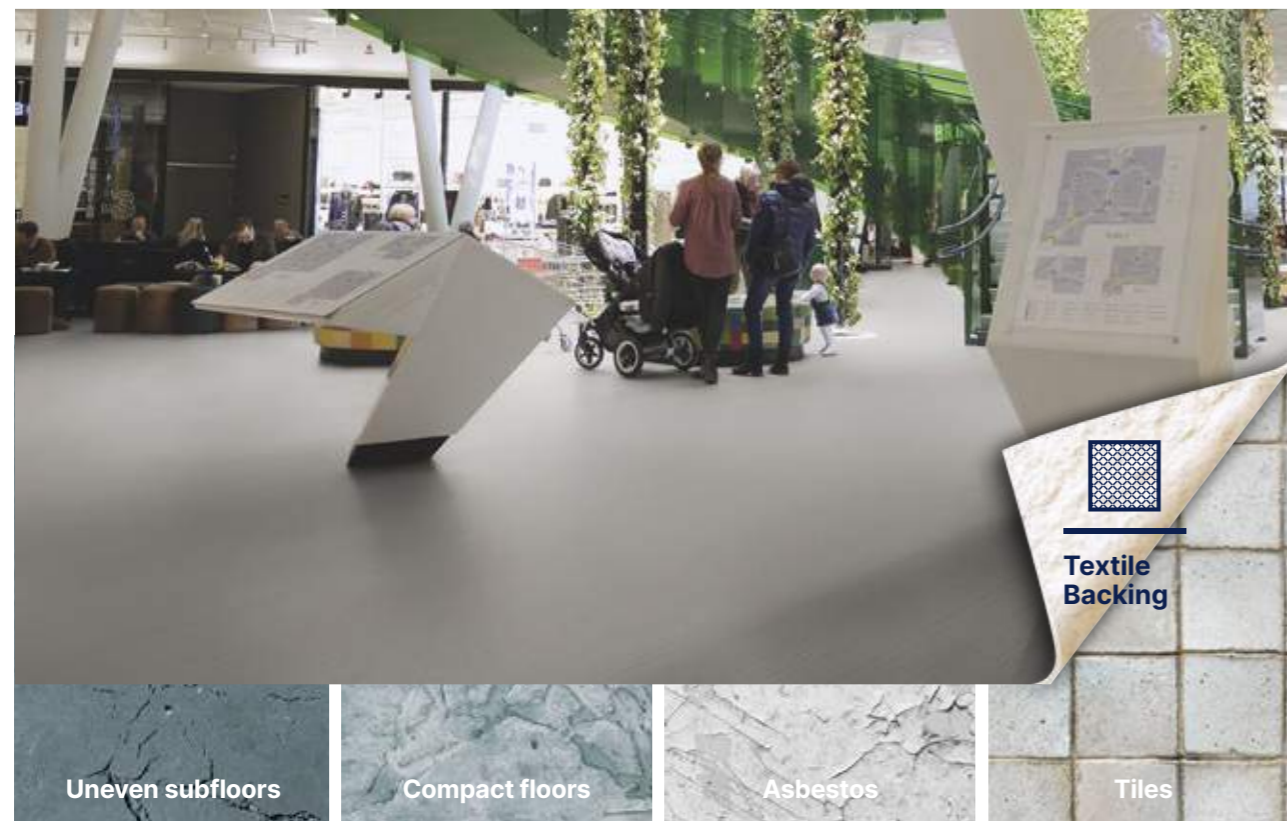

## Fast installation in one solution!



**Adhesive free**  
Apply double-sided tape (such as Fix&Free 100 Ref. 058U) on welding area and on room edges



**Hot welding**  
for 100% watertight hygienic system (Ref. CR40 0585)



**Cold welding**  
for invisible joint (see Romus #95605)



**Wall transition**

- Vynaflex skirtings, ideal for commercial applications (H 60 mm - Ref. 0483 / H 80 mm - Ref. 0482 / H 100 mm - Ref. 0477)
- Coving for 100% watertight hygienic system



**Entrance Mats**  
A new quick & easy installation of entrance mats with Quickmat Tile (Ref. 1725)

*More information on gerflor.com*

## Your sustainable flooring solution!

### Circular Economy

- 100% recyclable product
- Recycled content: backing made with recycled PET



= 1m<sup>2</sup>

### Indoor Air Quality

Adhesive Free installation means virtually no VOC!

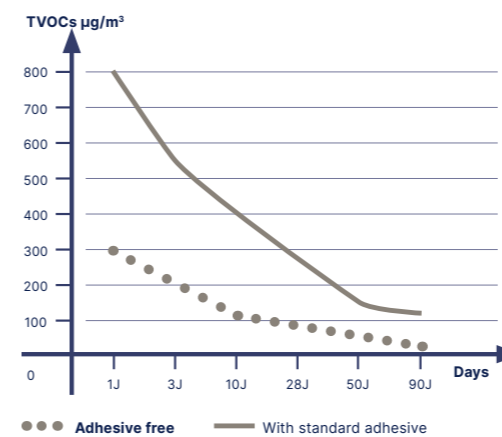



# Taralay Multilayered - fast track installation

## Taralay Libertex

Taralay Libertex

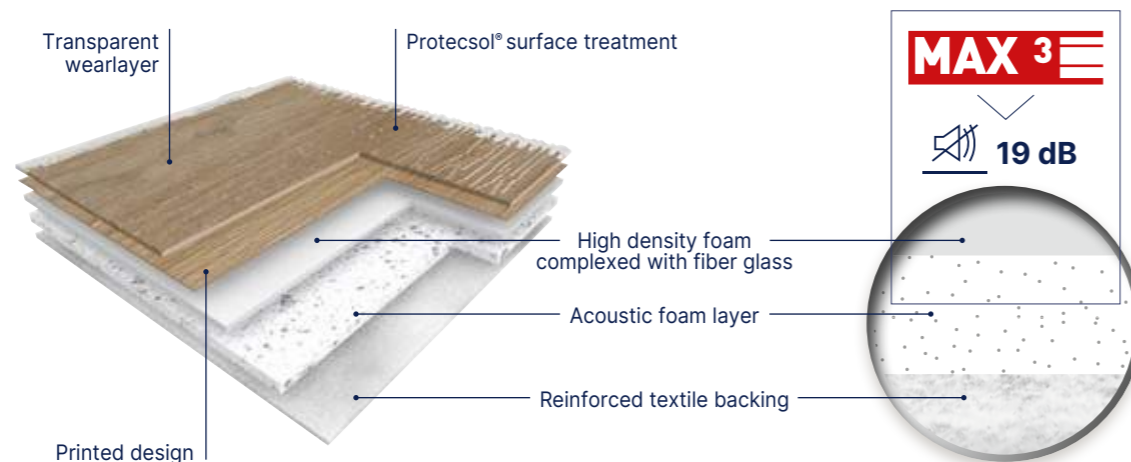

**TARALAY LIBERTEX** is ideal for fast track installation or renovations in commercial buildings. It is a multi-layered vinyl floorcovering with a printed design protected by a 0.70 mm thick transparent wear layer. The product features a high density foam complexed with fiber glass, an acoustic foam layer and a reinforced textile backing. It offers **19 dB sound insulation**.

It is available in 2 m and 4 m wide sheet, offers a R10 slip resistance and a group T wear rating. It is mechanically embossed, benefits from **Protecsol®** surface treatment and has an ultra matt look.

**TARALAY LIBERTEX** is a worry-free looselay solution. It is laid without glue, simply applying a double-sided tape such as Fix&Free on room edge and at the joint. Its textile backing absorbs surface irregularities requiring minimal subfloor preparation on uneven floors. It is compatible with cold welding, hot welding, coving, and Vynaflex skirtings.

It includes at least 30% mineral materials and 20% renewable materials. Textile backing is made at 95% from recycled PET bottles. It is 100% recyclable and 100% REACH compliant. Its VOC emissions after 28 days (ISO 16000) are below 100 microgram/m<sup>3</sup>. It is classified A + (the best class) for indoor air quality.



19 dB

Protecsol®



100% recyclable

### Fast track installation

- Minimal subfloor preparation: textile backing absorbs subfloor irregularities
- No shutdown, no odor, ideal for occupied rooms thanks to looselay installation
- No drying time, no glue

**Hygienic and easy maintenance:** Protecsol® surface treatment

**Comfort:** 19 dB sound reduction

Libertex

Description			
Total thickness	EN ISO 24346	mm	3.65
Thickness of wearlayer	EN ISO 24340	mm	0.70
Weight	EN ISO 23997	g/sqm	2900
Width of sheet	EN ISO 24341	cm	200/400
Length of sheet	EN ISO 24341	lm	20
Classification			
Norm / Product specification	-	-	EN ISO 11638
European classification	EN ISO 10874	class	34-43
Fire rating	EN 13501-1	class	Cfl-s1
Static electrical propensity	EN 1815	kV	< 2
Slip resistance wet	EN 16165:2021 – Appendix B (DIN 51 130)	class	R10
Performances			
Wear resistance	EN 660.2	mm <sup>3</sup>	≤ 2.0
Wear group	-	group	T
Dimensional stability (requirement)	EN ISO 23999	%	≤ 0.40
Dimensional stability (measured value)	-	-	≤ 0.05
Residual indentation (requirement)	EN ISO 24343-1	mm	≤ 0.20
Impact sound insulation	EN ISO 717-2	dB	19
Room impact	NF S 31 074	dB	< 65
Thermal conductivity	EN ISO 10456	W/(m.k)	0.25
Colour fastness	EN ISO 105-B02	degree	≥ 6
Surface treatment	-	-	Protecsol®
Chemical products resistance <sup>(1)</sup>	EN ISO 26987	-	OK
Environment / indoor air quality			
TVOC after 28 days	ISO 16000-6	microgram/m <sup>3</sup>	< 100
CE marking			



EN 14041



Textile Backing

(1) Regarding the resistance to chemicals, please download the corresponding leaflet from our website.  
 (2) The implementation of an effective cleaning regime is the most important defence against infection.



# Taralay Multilayered - fast track installation

## Taralay Libertex - Wood

 19 dB   
 
 Protectsol®   
 
 100% recyclable



2247 Hossegor Latte

### Legend



1430 - Legend Grey



No plank  
Continuous design



2243 - Legend Chestnut



No plank  
Continuous design



2242 - Legend Country



No plank  
Continuous design

### Cocoon



2241 - Cocoon Silver Brown



No plank  
Continuous design

### Hossegor



2247 - Hossegor Latte



10 × 100-67-33.3 cm

## Taralay Libertex - Wood

 19 dB   
 
 Protectsol®   
 
 100% recyclable



2245 Skandi Oak Natural

### Skandi Oak



2244 - Skandi Oak Clear



20 × 133.3 cm



2245 - Skandi Oak Natural



20 × 133.3 cm



2246 - Skandi Oak Toffee



20 × 133.3 cm

### Pure Oak



0720 - Pure Oak Clear



16 × 100 cm



1751 - Pure Oak Grey



16 × 100 cm



# Taralay Multilayered - fast track installation

## Taralay Libertex - Amsterdam / Paros

 19 dB    **Protecsol®**     100% recyclable



### Amsterdam



2151 Amsterdam Light Grey 



2152 Amsterdam Grey 



2153 Amsterdam Anthracite 



### Paros



2248 Paros Clear   
  
 333 x 86.6 cm

## Taralay Libertex - Reflect

 19 dB    **Protecsol®**     100% recyclable



2253 Reflect Silver 



2249 Reflect Sea 



2252 Reflect Forest 



2251 Reflect Sunny 

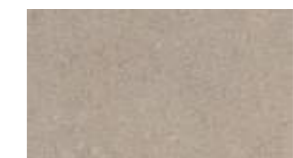

1785 Reflect Earth 



2252 Reflect Flower 



# Taralay Multilayered

## Taralay Impression

### Taralay Impression Compact

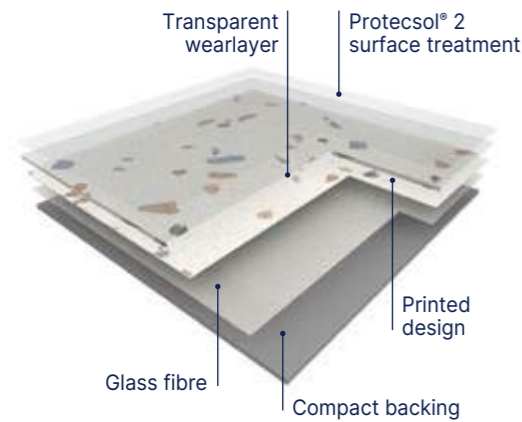

**TARALAY IMPRESSION COMPACT 0,7** is a multi-layered vinyl floorcovering, integrating a fiber glass and a printed design. It's available in 2 m wide sheet, with a group T wear rating. Total width of the product is 2 mm, including a transparent wear layer of 0.70 mm thick. **It offers 8 dB sound insulation and an indentation resistance of ca. 0.03 mm.** Its **dimensional stability** performs down to 0,08% (average measure). **TARALAY IMPRESSION COMPACT** is made in France. It's **100% recyclable**, and the floorcovering will have its individual EPD sheet. The flooring is equipped with **Protecsol® 2**, patented surface treatment obtained by UV laser cross-linking offering the best chemical resistance to the main products used in healthcare environment as betadine, eosin, hydro alcoholic solutions, making the maintenance easy and the floor long lasting. This treatment avoids applying any acrylic emulsion throughout the lifetime of the product. It is **free of formaldehyde, heavy metals and CMR 1 & 2 or vPvB** (very persistent and very bio accumulative) or PBT (persistent, bio-accumulative and toxic) and is 100% REACH compliant. Its VOC emissions after 28 days (ISO 16000-6) are below detection levels (<10 µg / m<sup>3</sup>) and this product is classified A + (the best class) and Floorscore® & M1 certified for indoor air quality. Taralay Impression Compact has antibacterial efficacy (E.coli / S.aureus / MRSA) : >99% after 24 hours according to ISO22196.

### Taralay Impression Acoustic

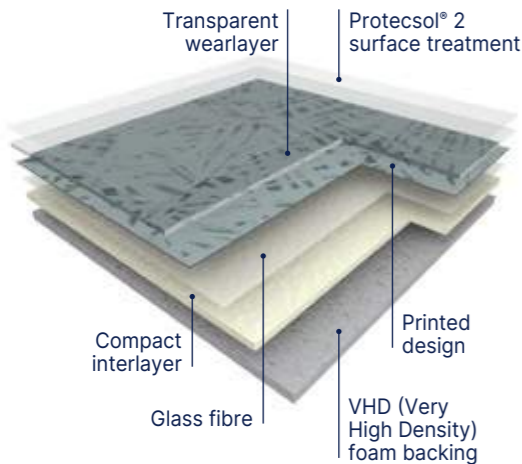

**TARALAY IMPRESSION ACOUSTIC 0,65** is a multi-layered vinyl floorcovering, integrating a **Very High Density foam backing**, reinforced with a fiber glass and a printed design. It's available in 2 m wide sheet, with a group T wear rating. Total width of the product is **3,35 mm**, including a transparent wear layer of 0.65 mm thick. It offers **19 dB sound insulation and an indentation resistance of ca. 0.08 mm.** Its **dimensional stability** performs down to **0,08%** (average measure). **TARALAY IMPRESSION ACOUSTIC** is made in France, with green electricity. It's **100% recyclable**, and the floorcovering will have its individual EPD sheet. The flooring is equipped with **Protecsol® 2**, patented surface treatment obtained by UV laser cross-linking offering the best chemical resistance to the main products used in healthcare environment as betadine, eosin, hydro alcoholic solutions, making the maintenance easy and the floor long lasting. This treatment avoids applying any acrylic emulsion throughout the lifetime of the product. It is **free of formaldehyde, heavy metals and CMR 1 & 2 or vPvB** (very persistent and very bio accumulative) or PBT (persistent, bio-accumulative and toxic) and is 100% REACH compliant. Its VOC emissions after 28 days (ISO 16000-6) are below detection levels (<10 µg / m<sup>3</sup>) and this product is classified A + (the best class) and Floorscore® & M1 certified for indoor air quality. Taralay Impression Compact has antibacterial efficacy (E.coli / S.aureus / MRSA) : >99% after 24 hours according to ISO22196.



- **Ultra-realistic designs:**  
Realistic embosses and plank dimensions for wood designs
- **Matt effect**
- **Extreme stain resistance, easy maintenance:**  
Protecsol® 2 surface treatment (patented technology by Gerflor)
- **High traffic resistance, long-lasting appearance**  
Available with a 0.7 mm wearlayer and available with a 0.9 mm wearlayer upon request (minimum order quantity of 800 sqm)
- **The best acoustic / indentation performance on the market**  
COMPACT: 0.03 mm / 8 dB  
ACOUSTIC: 0.08 mm / 19 dB
- **Eco-responsible solution**  
Best in class for indoor air quality (TVOC < 10 microgram/m<sup>3</sup> after 28 days)

			Taralay Impression Compact	Taralay Impression Acoustic
<b>Description</b>				
Total thickness	EN ISO 24346	mm	2.00	3.35
Wearlayer Thickness	EN ISO 24340	mm	0.70	0.65
Weight	EN ISO 23997	g/sqm	2635	2825
Width of sheet	EN ISO 24341	cm	200	200
Length of sheet	EN ISO 24341	lm	25	25
<b>Classification</b>				
Norm / Product specification	-	-	EN ISO 10582	EN ISO 11638
European classification	EN ISO 10874	class	34-43	34-42
Fire rating	EN 13501-1	class	Bfl-s1	Bfl-s1
Static electrical propensity	EN 1815	kV	< 2	< 2
Slip resistance	EN 16165:2021 – Appendix B (DIN 51 130)	class	R10	R10
<b>Performances</b>				
Wear resistance	EN 660.2	mm <sup>3</sup>	≤ 2.0	≤ 2.0
Wear group	-	group	T	T
Type Binder content	EN ISO 10582	type	I	-
Dimensional stability (requirement)	EN ISO 23999	%	≤ 0.40	≤ 0.40
Dimensional stability (measured value)	-	%	0,08	0,08
Residual indentation (requirement)	EN ISO 24343-1	mm	≤ 0.10	≤ 0.20
Residual indentation (average measured value)	-	mm	≈ 0.03	≈ 0.08
Impact sound insulation	EN ISO 717-2	dB	8	19
Castor chair test (type H)	ISO 4918	-	OK	OK
Thermal conductivity	EN ISO 10456	W/(m.k)	0.25	0.25
Colour fastness	EN ISO 105-B02	degree	≥ 6	≥ 6
Surface treatment	-	-	PROTECSOL® 2	PROTECSOL® 2
Chemical products resistance <sup>(1)</sup>	EN ISO 26987	-	OK	OK
Anti-bacterial activity (E. coli - S. aureus - MRSA) after 24h <sup>(2)</sup>	ISO 22196	-	> 99% inhibits growth	> 99% inhibits growth
Anti-viral activity (human coronavirus) after 2h <sup>(2)</sup>	ISO 21702	-	> 99.7% virucidal activity	> 99.7% virucidal activity
<b>Environment / indoor quality air</b>				
TVOC after 28 days	ISO 16000-6	microgram/m <sup>3</sup>	< 10	< 10
Certification	-	-	Floorscore®	Floorscore®
<b>CE Marking</b>				



EN 14041



(1) Regarding the resistance to chemicals, please download the corresponding leaflet from our website.  
(2) The implementation of an effective cleaning regime is the most important defence against infection.



# Taralay Multilayered

Taralay Impression **hop** : the loose-lay solution



## Eco-design valued at each stage of the life cycle

### GERFLOR COMMITTED

to communicating transparently about the carbon impact of its products and focusing on eco-design, including the use of sustainable raw materials, the sustainability of its products and circular economy

### 1- Raw materials

**+ 15%** Recycled content

TVOC < 10 micrograms/m<sup>3</sup>

Reach compliant\*

### 4- A second life made easier

**100% RECYCLABLE** 100% recyclable

Uninstall and re-use:  
 • Flooring can be uninstalled without damaging either the product or the surface underneath  
 • Flooring can be re-used for another building

Easy to recycle  
 • Qualifies for the **the Second Life Programme**  
 • Flooring is incorporated back into our production lines

**FLOOR TO FLOOR** A unique partnership with Paprec, recycling programmes that are certified by Europlast



Accelerating recycling is essential for building a more circular economy. Preserving resources and reducing the carbon footprint of our business are our commitments for Sustainable Development.

\* Registration, Evaluation and Authorisation of Chemicals

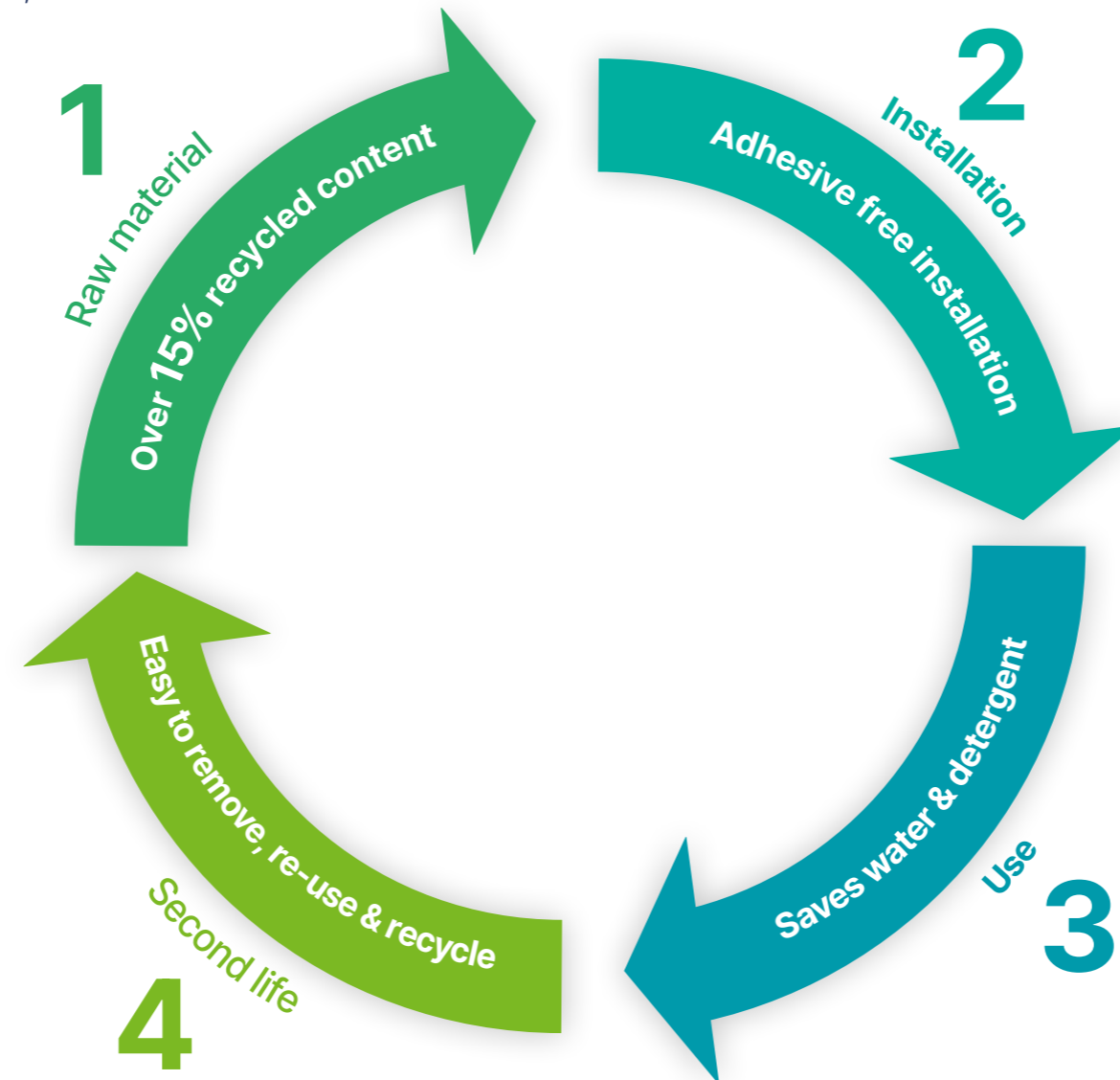

### 2- Installation

made easy in busy environments

**hop** Reinforced holding tape!

Adhesive free

Reduced downtime

Qualifies for the **Second Life Programme**

### 3- Use

Long-lasting performance

**Protecsol® 2**: stain resistant water-repellent surface saves water and detergent

Withstands wheeling heavy loads (straight or circular) up to 500 kg

Excellent resistance to indentation 0.03 mm (compact) / 0.08mm (acoustic)

Excellent stability, even during temperature changes: expansion < 0.03%

Improved resistance to moisture



# Taralay Multilayered

## Taralay Impression hop

### Taralay Impression hop Compact

**TARALAY IMPRESSION HOP COMPACT 0,7** is a multi-layered vinyl floorcovering, integrating a **double fiber frame** and a printed design. It's available in 2 m wide sheet, with a group T wear rating.

The system TARALAY IMPRESSION HOP COMPACT - floorcovering + holding tape « HOP tape », code 059E0001- enables to **lay down flooring gluefree**.

Thanks to its **double fiber frame** -fiber veil + fiber grid-, and its calendared interlayer, the floorcovering achieves a **high level of stability**, even under temperature variations and heavy rolling loads. It can be laid down onto **various existing supports**, including asbestos. Perfectly suitable for renovation or new buildings construction.

Without any glue, its **end life removal is fast and easy**. The Gerflor holding tape doesn't affect the support, to ease renovation. Re-use of the floorcovering, recycle or renovation are then facilitated.

Total width of the product is **2,30 mm**, including a transparent wear layer of 0.70 mm thick. It offers **8 dB sound insulation** and an **indentation resistance of ca. 0.03 mm**. Its **dimensional stability** performs down to **0,03%** (average measure).

**TARALAY IMPRESSION HOP COMPACT** is made in France.

It's made of **15% minimum post-consumed PVC**, and goes up to 25% in total.

The flooring is equipped with **Protecsol® 2**, patented surface treatment obtained by UV laser cross-linking offering the best chemical resistance to the main products used in healthcare environment as betadine, eosin, hydro alcoholic solutions, making the maintenance easy and the floor long lasting. This treatment avoids applying any acrylic emulsion throughout the lifetime of the product.

It is **free of formaldehyde, heavy metals and CMR 1 & 2 or vPvB** (very persistent and very bio accumulative) or PBT (persistent, bio-accumulative and toxic) and is 100% REACH compliant. Its VOC emissions after 28 days (ISO 16000-6) are below detection levels (<10 µg / m³) and this product is classified A + (the best class) and Floorscore® & M1 certified for indoor air quality. Taralay Impression Compact has antibacterial efficacy (E.coli / S.aureus / MRSA) : >99% after 24 hours according to ISO22196.

It's **100% recyclable**, and the floorcovering will have its individual EPD sheet.

### Taralay Impression hop Acoustic

**TARALAY IMPRESSION HOP ACOUSTIC 0,7** is a multi-layered vinyl floorcovering, integrating a **double fiber frame**, a **Very High Density foam** backing and a printed design. It's available in 2 m wide sheet, with a group T wear rating.

The system TARALAY IMPRESSION HOP ACOUSTIC - floorcovering + holding tape « HOP tape », code 059E0001- enables to **lay down flooring gluefree**.

Thanks to its **double fiber frame** -fiber veil + fiber grid-, and its **calendared interlayer**, the floorcovering achieves a **high level of stability**, even under temperature variations and heavy rolling loads. It can be laid down onto **various existing supports**, including asbestos. Perfectly suitable for renovation or new buildings construction.

Without any glue, its **end life removal is fast and easy**. The Gerflor holding tape doesn't affect the support, to ease renovation. Re-use of the floorcovering, recycle or renovation are then facilitated.

Total width of the product is **4,35 mm**, including a transparent wear layer of 0.70 mm thick. It offers **19 dB sound insulation** and an **indentation resistance of ca. 0.08 mm**. Its **dimensional stability** performs down to **0,03%** (average measure).

**TARALAY IMPRESSION HOP ACOUSTIC** is made in France. It's made of **15% minimum post-consumed PVC**, and goes up to 25% in total.

The flooring is equipped with **Protecsol® 2**, patented surface treatment obtained by UV laser cross-linking offering the best chemical resistance to the main products used in healthcare environment as betadine, eosin, hydro alcoholic solutions, making the maintenance easy and the floor long lasting. This treatment avoids applying any acrylic emulsion throughout the lifetime of the product.

It is **free of formaldehyde, heavy metals and CMR 1 & 2 or vPvB** (very persistent and very bio accumulative) or PBT (persistent, bio-accumulative and toxic) and is 100% REACH compliant. Its VOC emissions after 28 days (ISO 16000-6) are below detection levels (<10 µg / m³) and this product is classified A + (the best class) and Floorscore® & M1 certified for indoor air quality. Taralay Impression Compact has antibacterial efficacy (E.coli / S.aureus / MRSA) : >99% after 24 hours according to ISO22196.

It's **100% recyclable**, and the floorcovering will have its individual EPD sheet.

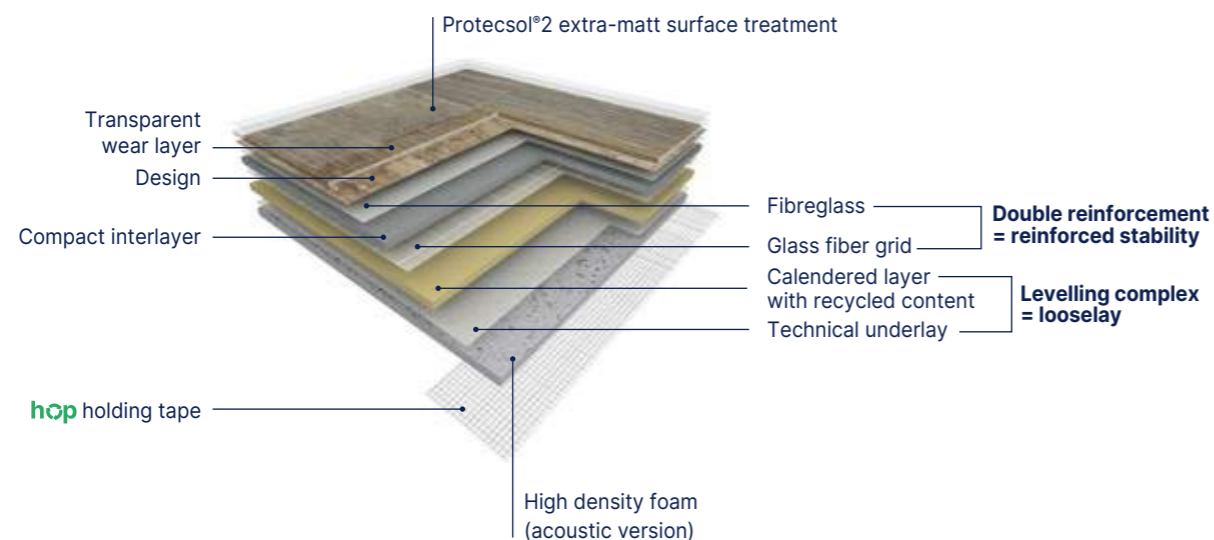

- **Innovative & eco designed solution for looselay installation**
- **Gluefree solution means quick and easy :** save up to 50% installation time
- **15% recycled content inside**

- **Protecsol®2 surface treatment:** the best stain resistance thanks to water-repellent properties
- **Acoustic version :** VHD foam for an acoustic insulation (-19db) - walking wellness and low impact sound

Description	Taralay Impression hop Compact		Taralay Impression hop Acoustic	
	EN ISO	unit	value	value
Total thickness	EN ISO 24346	mm	2.30	4.35
Wearlayer Thickness	EN ISO 24340	mm	0.70	0.70
Weight	EN ISO 23997	g/sqm	3125	3670
Width of sheet	EN ISO 24341	cm	200	200
Length of sheet	EN ISO 24341	lm	20	20
<b>Classification</b>				
Norm / Product specification	-	-	EN ISO 10582	EN ISO 11638
European classification	EN ISO 10874	class	34-43	34-42
Fire rating	EN 13501-1	class	Bfl-s1	Bfl-s1
Static electrical propensity	EN 1815	kV	< 2	< 2
Slip resistance	EN 16165:2021 – Appendix B (DIN 51 130)	class	R10	R10
<b>Performances</b>				
Wear resistance	EN 660.2	mm³	≤ 2.0	≤ 2.0
Wear group	-	group	T	T
Type Binder content	EN ISO 10582	type	I	I
Dimensional stability (requirement)	EN ISO 23999	%	≤ 0.40	≤ 0.40
Dimensional stability (measured value)	-	%	0,03	0,03
Residual indentation (requirement)	EN ISO 24343-1	mm	≤ 0.10	≤ 0.20
Residual indentation (average measured value)	-	mm	≈ 0.03	≈ 0.08
Impact sound insulation	EN ISO 717-2	dB	8	19
Castor chair test (type H)	ISO 4918	-	OK	OK
Thermal conductivity	EN ISO 10456	W/(m.k)	0.25	0.25
Colour fastness	EN ISO 105-B02	degree	≥ 6	≥ 6
Surface treatment	-	-	PROTECSOL® 2	PROTECSOL® 2
Chemical products resistance <sup>(1)</sup>	EN ISO 26987	-	OK	OK
Anti-bacterial activity (E. coli - S. aureus - MRSA) after 24h <sup>(2)</sup>	ISO 22196	-	> 99% inhibits growth	> 99% inhibits growth
Anti-viral activity (human coronavirus) after 2h <sup>(2)</sup>	ISO 21702	-	> 99.7% virucidal activity	> 99.7% virucidal activity
<b>Environment / indoor quality air</b>				
TVOC after 28 days	ISO 16000-6	microgram/m³	< 10	< 10
Certification	-	-	Floorscore®	Floorscore®
<b>CE Marking</b>				
CE	EN 14041			



(1) Regarding the resistance to chemicals, please download the corresponding leaflet from our website.  
 (2) The implementation of an effective cleaning regime is the most important defence against infection.



# Taralay Multilayered

Taralay Impression / Taralay Impression **hop**  
Wood Fusion / Rivau Nature

 Compact 
  Acoustic 
 19 dB 
  Protectsol® 2 
  100% recyclable



1104 Wood Fusion Nature

Wood Fusion



1104 Wood Fusion Nature  20 cm 

Taralay Impression / Taralay Impression **hop**  
Habana 3D / Raintree



1100 Habana 3D Blossom

Habana 3D



1100 Habana 3D Blossom  16,6 cm 



1069 Habana 3D Trinidad  16,6 cm 



1070 Habana 3D Vinales  16,6 cm 



1110 Rivau Nature

Rivau Nature



1110 Rivau Nature  7 x 35 cm 

\*Available in Taralay Impression **hop**



1077 Raintree Natural

Raintree



1077 Raintree Natural  2,5 cm 



1076 Raintree Grey  2,5 cm 

\*Available in Taralay Impression **hop**



# Taralay Multilayered

Taralay Impression / Taralay Impression **hop**  
Nature Oak / Noma

 Compact
  Acoustic
 19 dB
  Protectsol® 2
  100% recyclable



1055 Nature Oak Clear

## Nature Oak



1055 Nature Oak Clear  16,6 cm 



1053 Nature Oak Blond  16,6 cm 



1056 Nature Oak Dark  16,6 cm 



1054 Nature Oak Brown  16,6 cm 

## Noma



0519 Noma Beige  16,6 cm 



0373 Noma Ice  16,6 cm 

\*Available in Taralay Impression **hop**

Taralay Impression / Taralay Impression **hop**  
Charme / Walnut / Moon Island



1093 Charme Kraft

## Charme



1093 Charme Kraft  20 cm 



0723 Charme Pecan  20 cm 

## Walnut

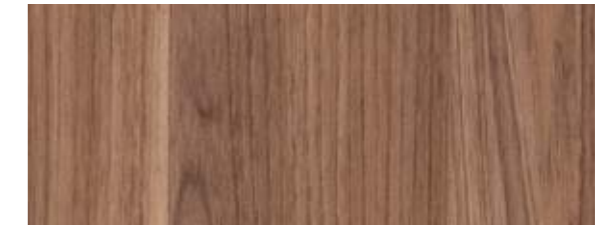

1314 Walnut Brown  10 cm 



0760 Moon Island

## Moon Island



0760 Moon Island  16,6 cm 

\*Available in Taralay Impression **hop**



# Taralay Multilayered

Taralay Impression / Taralay Impression **hop**  
Sycamore / Portobello

 Compact 
  Acoustic 
 19 dB 
  Protectsol® 2 
  100% recyclable



0725 Sycamore Light Brown

## Sycamore



0725 Sycamore Light Brown



No plank  
Continuous design



0727 Sycamore Vanilla



No plank  
Continuous design

Taralay Impression / Taralay Impression **hop**  
Infinity

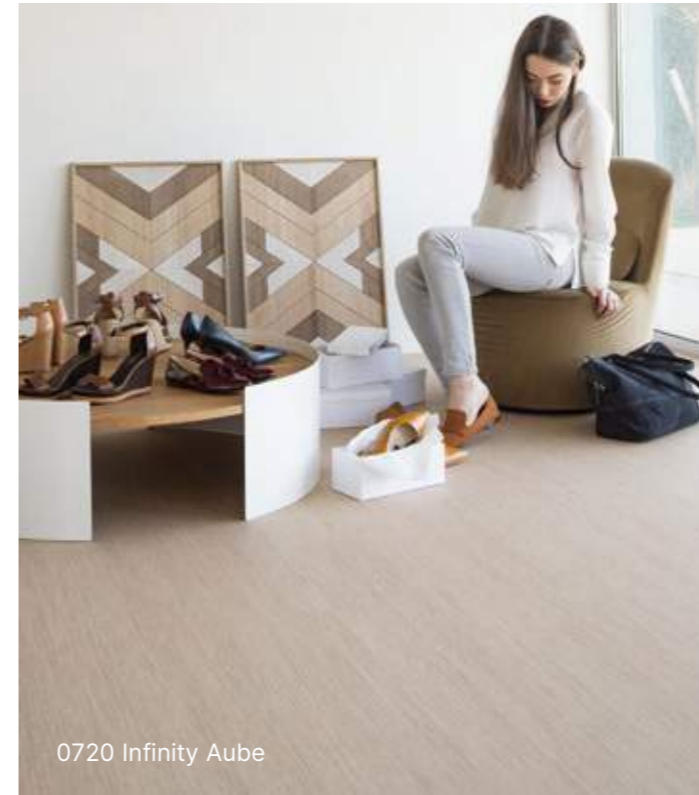

0720 Infinity Aube

## Infinity



0680 Infinity Greige



No plank  
Continuous design

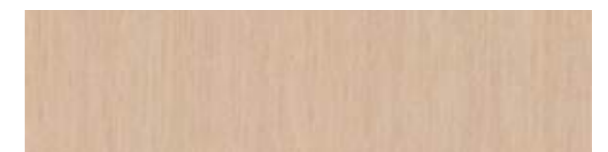

0720 Infinity Aube



No plank  
Continuous design



0773 Portobello

## Portobello



0773 Portobello



16,6 cm

Colour Reference	Colour Name	Pattern Repeat	Planks Sizes
		Width x Length (mm)	
0373	Noma Ice	1000×1000	166×1000
0519	Noma Beige	1000×1000	166×1000
0680	Infinity Greige	1000×1000	No plank Continuous design
0720	Infinity Aube	1000×1000	No plank Continuous design
0723	Charme Pecan	1000×1000	200×1000
0725	Sycamore Light Brown	1000×1000	No plank Continuous design
0727	Sycamore Vanilla	1000×1000	No plank Continuous design
0760	Moon Island	1000×1000	166×1000
0773	Portobello	1000×1000	166×1000
0923	Happy Road	2000×6000	-
1041	Chess Black & White	1000×1000	250×250
1053	Nature Oak Blond	2000×1000	166×1000
1054	Nature Oak Brown	2000×1000	166×1000
1055	Nature Oak Clear	2000×1000	166×1000
1056	Nature Oak Dark	2000×1000	166×1000
1069	Habana 3D Trinidad	1000×1000	166×1000
1070	Habana 3D Vinales	1000×1000	166×1000
1076	Raintree Grey	1000×1000	25 random lenght
1077	Raintree Natural	1000×1000	25 random lenght
1093	Charme Kraft	1000×1000	200×1000
1098	Envol Black & White	2000×6000	-
1099	Envol Forest	2000×6000	-
1100	Habana 3D Blossom	2000×6000	166×1000
1101	Happy Form	2000×6000	-
1102	Happy Number Blue	2000×3000	-
1103	Happy Number Grey	2000×3000	-
1104	Wood Fusion Nature	1000×6000	200 x random lenght
1110	Rivau Nature	1000×1000	70×350
1314	Walnut Brown	1000×1000	100×1000

\*Available in Taralay Impression **hop**



# Taralay Multilayered

Taralay Impression / Taralay Impression **hop**  
Cemento / Terrazzo

 Compact 
  Acoustic 
 19 dB 
  Protectsol® 2 
  100% recyclable



## Cemento

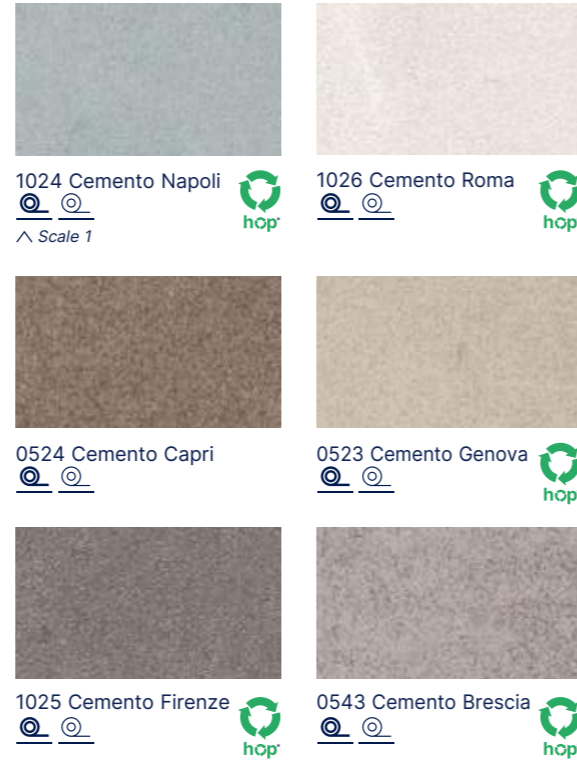

Taralay Impression / Taralay Impression **hop**  
Rough / Riverside

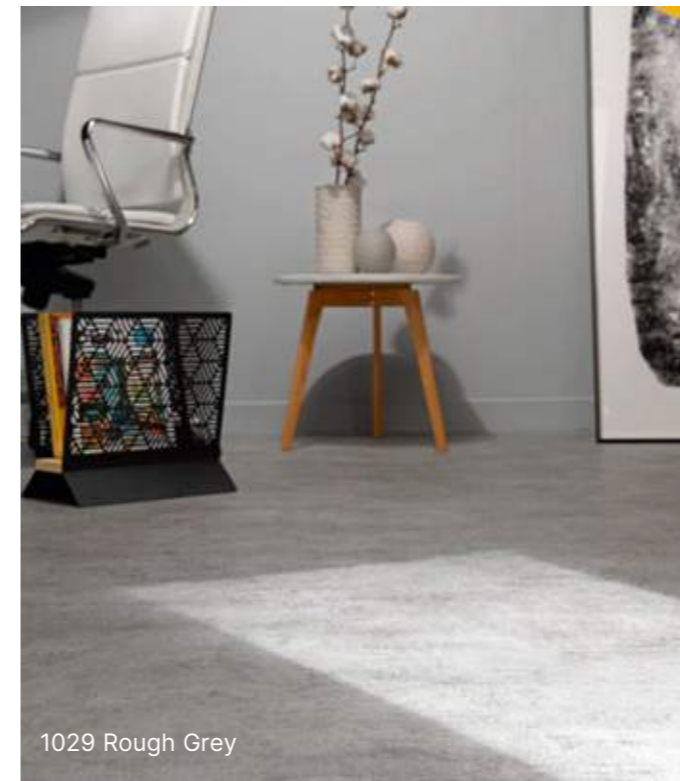

## Rough

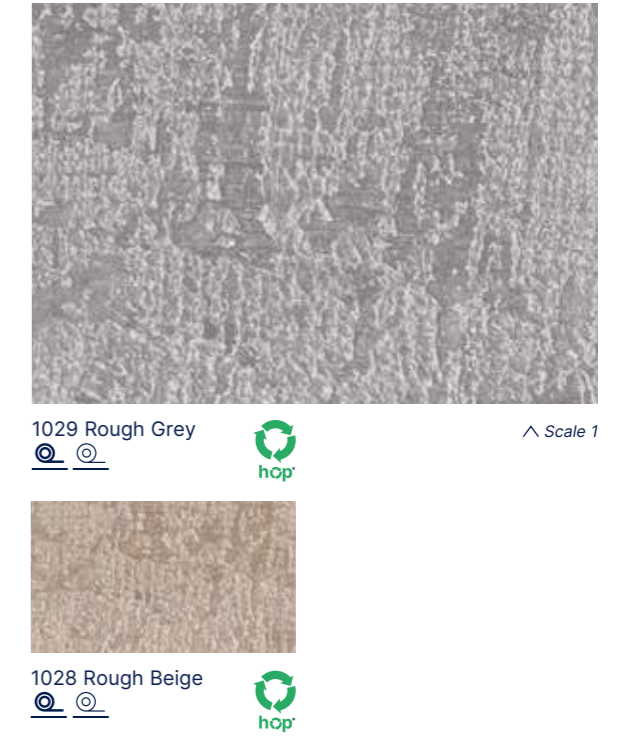

## Terrazzo



## Riverside



\*Available in Taralay Impression **hop**



# Taralay Multilayered

Taralay Impression / Taralay Impression **hop**  
Gentlemen / Pure Wool

 Compact
  Acoustic
 19 dB
  Protectsol® 2
  100% recyclable

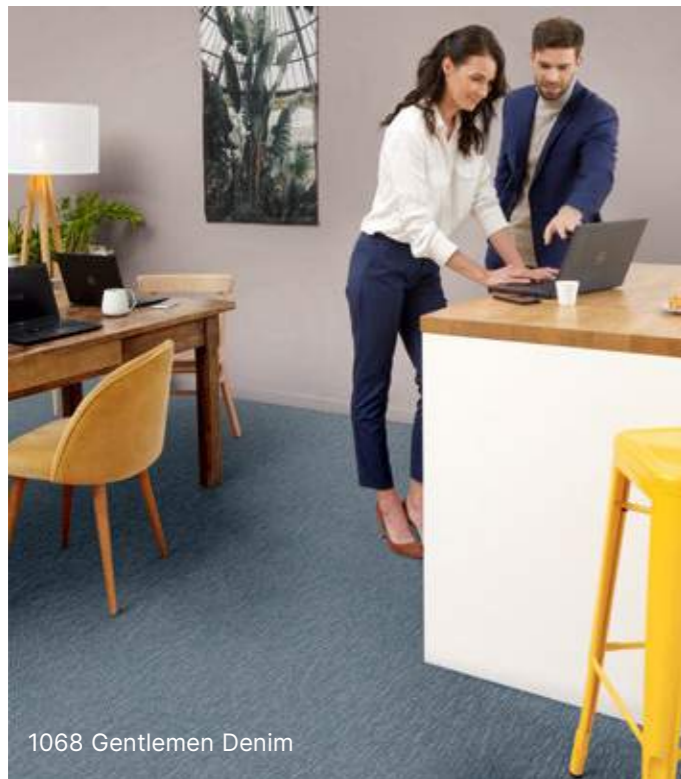

## Gentlemen



1068 Gentlemen Denim   ^ Scale 1



1067 Gentlemen Black & White 

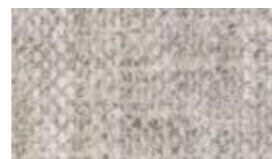

0770 Gentlemen Clear 



## Pure Wool



1072 Pure Wool Grey   ^ Scale 1



1071 Pure Wool Taupe 



1074 Pure Wool Teal 



1073 Pure Wool Beige 

\*Available in Taralay Impression **hop**

Taralay Impression / Taralay Impression **hop**  
Finesse

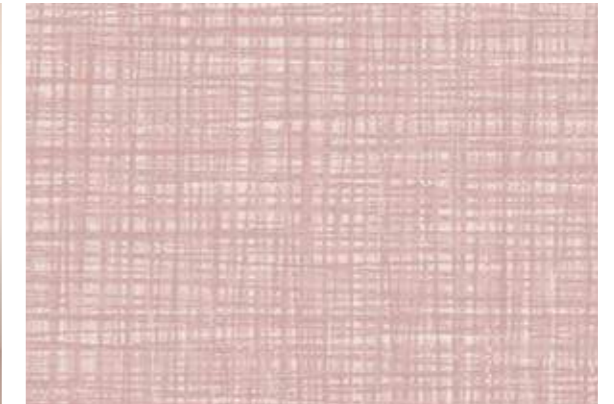

1066 Finesse Poudre   ^ Scale 1



1063 Finesse Brown 



1065 Finesse Paille 



1064 Finesse Nature 

\*Available in Taralay Impression **hop**



# Taralay Multilayered

Taralay Impression / Taralay Impression **hop**  
Envol / Jungle

 Compact 
  Acoustic 
 19 dB 
  Protectsol® 2 
  100% recyclable

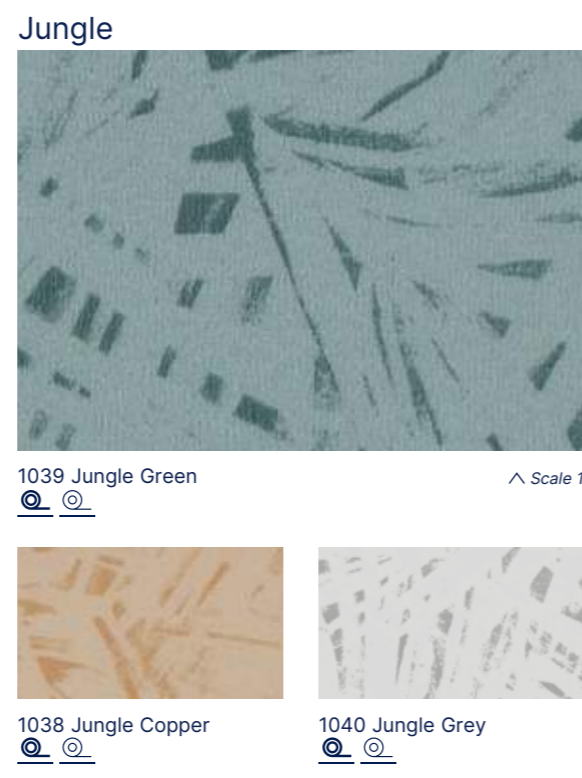
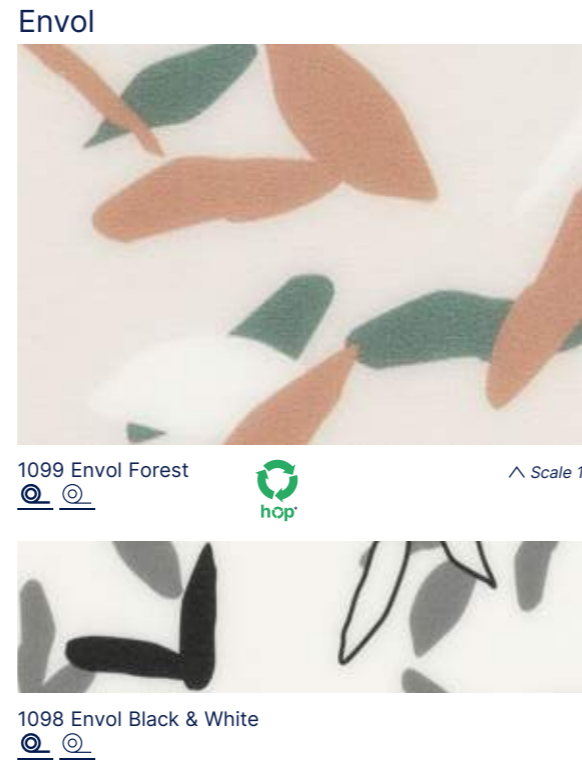

\*Available in Taralay Impression **hop**

Taralay Impression / Taralay Impression **hop**  
Nido / Rice





# Taralay Multilayered

Taralay Impression  
Kubes / Flipkube

 Compact
  Acoustic
 19 dB
  Protocolsol® 2
  100% recyclable



1050 Kubes Indigo / 1042 Flipkube Indigo

## Kubes



1050 Kubes Indigo

^ Scale 1

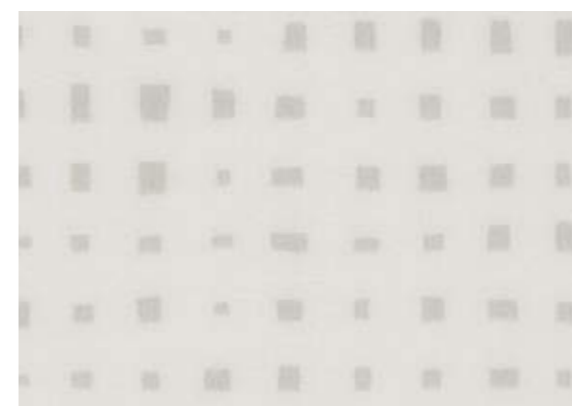

0755 Kubes White

^ Scale 1



1030 Kubes Fuschia



1031 Kubes Carmine



1047 Kubes Lemon



1027 Kubes Corail



1046 Kubes Anis



## Flipkube



1042 Flipkube Indigo

^ Scale 1



1045 Flipkube White

^ Scale 1



1044 Flipkube Lagoon



1075 Flipkube Purple



1043 Flipkube Garden





# Taralay Multilayered

Taralay Impression / Taralay Impression **hop**  
Metallic / Nest

 Compact
  Acoustic
 19 dB
  Protectsol® 2
  100% recyclable



\*Available in Taralay Impression **hop**

Taralay Impression / Taralay Impression **hop**  
Chess Black & White



Taralay Multilayered



# Taralay Multilayered

Taralay Impression  
Happy Number / Happy Form

Compact Acoustic 19 dB Protcsol® 2 100% recyclable

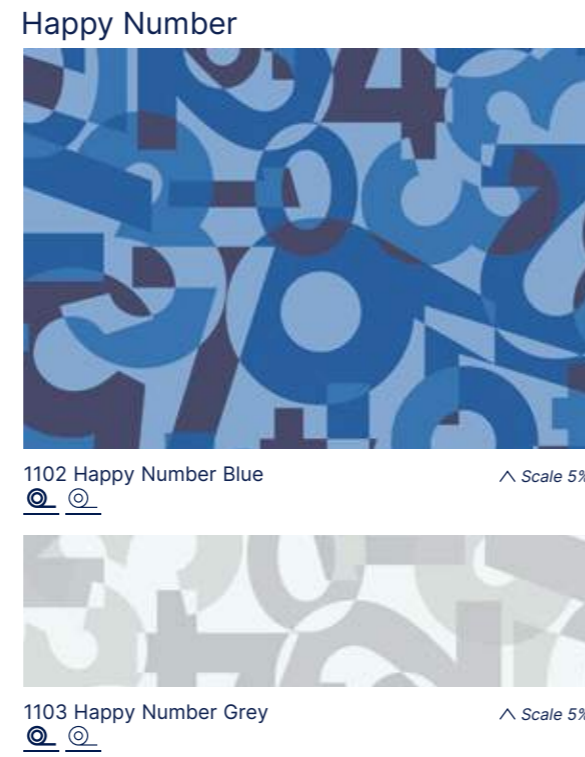

Taralay Impression  
Happy Road





# Taralay Multilayered

Taralay Impression / Taralay Impression **hop**  
Uni Matt

 Compact
  Acoustic
 19 dB
  Protocolsol® 2
  100% recyclable



1092 Uni Matt Light Beige / 1103 Happy Number Grey



1084 Uni Matt Jungle Grey  
 

^ Scale 1



0832 Uni Matt Grey  
 

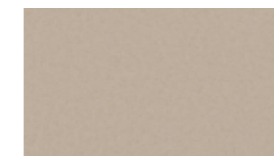



1088 Uni Matt Dark Beige  
 

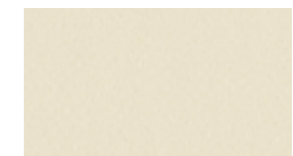

1092 Uni Matt Light Beige  
 



0848 Uni Matt White  
 



1091 Uni Matt Corail  
 



1089 Uni Matt Copper  
 



1090 Uni Matt Brick  
 



1086 Uni Matt Poudre  
 



1087 Uni Matt Yellow  
 



1082 Uni Matt Light Green  
 



1081 Uni Matt Lagoon  
 

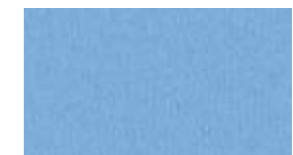

1078 Uni Matt Indigo  
 



1080 Uni Matt Green  
 



1079 Uni Matt Dark Green  
 



1085 Uni Matt Teal  
 



1083 Uni Matt Navy  
 

\*Available in Taralay Impression **hop**



# Taralay Multilayered

My Taralay Impression

## Beyond the norm

As you are unique and each of your projects represents a new challenge, Gerflor gives you the chance to stand out, from 50sqm.

One atmosphere, one style, one floor, but several possibilities...

## 3 possibilities



### 1 - COLOUR

the possibility to recolour 32 designs in the Taralay Impression range as you wish



1

Select a design\* from the Taralay Impression range



2

Change the colour scheme as you wish



3

Receive your floor sample within 10 days of acceptance of your inquiry by Gerflor



4

Receive and install your customised flooring; delivery lead time: 6 weeks from receipt of your order

\* from among 32 eligible designs (see Brochure My Taralay Impression)

"ENVOL" DESIGN  
STANDARD COLOUR SCHEME



CUSTOMISED COLOUR 1



CUSTOMISED COLOUR 2



Minimum order: 50 m<sup>2</sup> (special pricing system)

If you have any questions (pricing, feasibility, technical information), do not hesitate to contact your sales representative



# Taralay Multilayered

My Taralay Impression



## 2 - COLLECTION

the possibility to select from among **50 exclusive designs**

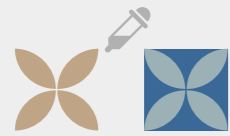

1

Draw inspiration from Gerflor's 50 exclusive designs and change, if you so wish, the design's colour scheme on [www.myfloorbygerflor.com](http://www.myfloorbygerflor.com)



2

View your customised design on your computer screen before approving it

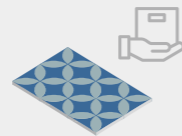

3

Receive your floor sample within 10 days of acceptance of your inquiry by Gerflor

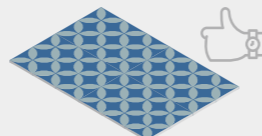

4

Receive and install your customised flooring; delivery lead time: 6 weeks from receipt of your order



## 3 - CUSTOMISATION

the possibility to make your floor unique



1

Send us your own file in accordance with the process described in our **specifications**



2

Approval by our technical team

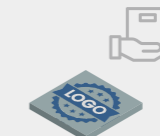

3

Receive your floor sample within 10 days and before all of your floor is made

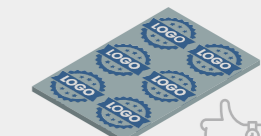

4

Receive and install your customised flooring; delivery lead time: 6 weeks from receipt of your order



File formats accepted



Files free from copyright only



300 DPI resolution



RAL, Pantone and NCS colour reference

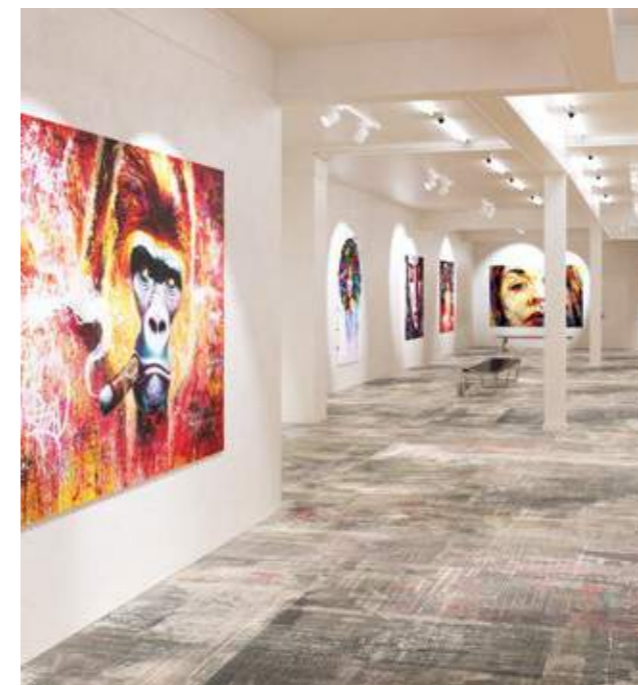

To enhance the visual identity of your company or that of your clients, you can have your logo printed across the width of the roll.

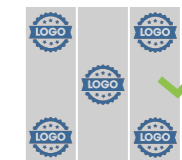

- No metallic ink
- No printing on a plain background
- Design only across the width (2 m)
- No continuity of designs over several rolls





# Taralay Multilayered

## Taralay Initial

### Taralay Initial Compact

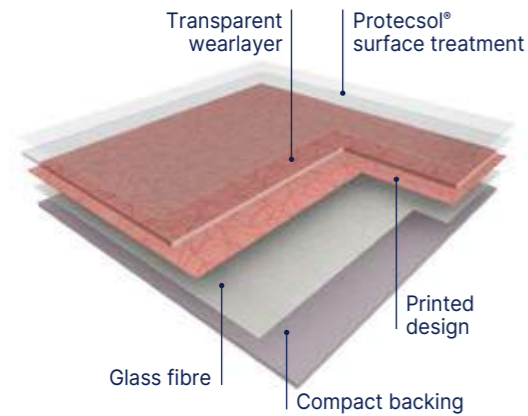

**TARALAY INITIAL COMPACT** is a multi-layered vinyl floorcovering, available in 2 m wide sheet, with a group T wear rating.

The product comprises a compacted backing reinforced with a glass fibre and a printed design that is protected by a transparent wear layer (0.70 mm thick). It offers 6 dB sound insulation and an indentation resistance of 0.03 mm.

It is treated with **Protocolsol**, a UV cured surface treatment, which facilitates ease of maintenance and eliminates permanently the need for acrylic emulsion (metallisation).

According to ISO 21702, **TARALAY INITIAL COMPACT** has **anti-viral activity** against Human Coronaviruses: it reduces the number of virus by 99.3% after 2h.

According to ISO 22196, **TARALAY INITIAL COMPACT** has **anti-bacterial activity** against E. coli, S. aureus and MRSA of 99% after 24h.

These products do not contain any heavy metals or CMR 1&2 and are 100% compliant with REACH. The products emission rate of volatile organic compounds is < 10 microgram/m<sup>3</sup> (TVOC after 28 days – ISO 16000-6).

It is 100% recyclable.

### Taralay Initial Acoustic

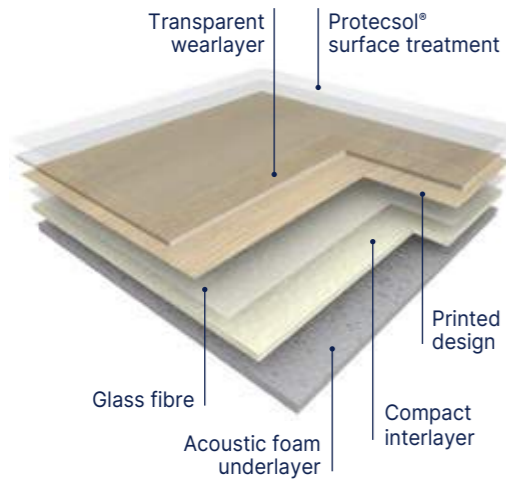

**TARALAY INITIAL ACOUSTIC** is an acoustic multi-layered vinyl floorcovering, available in 2 m wide sheet, with a group T wear rating.

The product comprises a foam backing reinforced with a glass fibre and a printed design that is protected by a transparent wear layer (0.65 mm thick). It offers **19 dB** sound insulation and an indentation resistance of 0.10 mm.

It is treated with **Protocolsol**, a UV cured surface treatment, which facilitates ease of maintenance and eliminates permanently the need for acrylic emulsion (metallisation).

According to ISO 21702, **TARALAY INITIAL ACOUSTIC** has **anti-viral activity** against Human Coronaviruses: it reduces the number of virus by 99.3% after 2h.

According to ISO 22196, **TARALAY INITIAL ACOUSTIC** has **anti-bacterial activity** against E. coli, S. aureus and MRSA of 99% after 24h.

It does not contain any heavy metals or CMR 1&2 and is 100% compliant with REACH. The products emission rate of volatile organic compounds is < 10 microgram/m<sup>3</sup> (TVOC after 28 days – ISO 16000-6).

It is 100% recyclable.



- All references are available in **Compact** and **Acoustic**
- High resistance to indentation **0.03 mm (Compact)** and **0.10 mm (Acoustic)**
- High impact insulation **6 dB (Compact)** and **19 dB (Acoustic)**
- **Protocolsol** Surface Treatment (easy maintenance & no wax)
- Highest performance in **TVOC emission < 10 microgram/m<sup>3</sup>**

Description			Taralay Initial Compact Pro	Taralay Initial Acoustic Pro
<b>Description</b>				
Total thickness	EN ISO 24346	mm	2.00	3.35
Thickness of wearlayer	EN ISO 24340	mm	0.70	0.65
Weight	EN ISO 23997	g/sqm	2635	2825
Width of sheet	EN ISO 24341	cm	200	200
Length of sheet	EN ISO 24341	lm	25	25
<b>Classification</b>				
Norm / Product specification	-	-	EN ISO 10582	EN ISO 11638
European classification	EN ISO 10874	class	34-43	34-42
Fire rating	EN 13501-1	class	Bfl-s1	Bfl-s1
Static electrical propensity	EN 1815	kV	< 2	< 2
Slip resistance wet	EN 16165:2021 – Appendix B (DIN 51130)	class	R10	R10
<b>Performances</b>				
Wear resistance	EN 660.2	mm <sup>3</sup>	≤ 2.0	≤ 2.0
Wear group	-	group	T	T
Type Binder content	EN ISO 10582	type	I	-
Dimensional stability	EN ISO 23999	%	≤ 0.40	≤ 0.40
Residual indentation (requirement)	EN ISO 24343-1	mm	≤ 0.10	≤ 0.20
Residual indentation (average measured value)	-	mm	≈ 0.03	≈ 0.10
Impact sound insulation	EN ISO 717-2	dB	6	19
Castor chair test (type H)	ISO 4918	-	OK	OK
Thermal conductivity	EN ISO 10456	W/(m.k)	0.25	0.25
Colour fastness	EN ISO 105-B02	degree	≥ 6	≥ 6
Surface treatment	-	-	Protocolsol®	Protocolsol®
Chemical products resistance	EN ISO 26987	-	OK	OK
Anti-bacterial activity (E. coli - S. aureus - MRSA) <sup>(1)</sup>	ISO 22196	-	> 99% inhibits growth	> 99% inhibits growth
Anti-viral activity (human coronavirus) after 2h <sup>(1)</sup>	ISO 21702	-	> 99.3% virucidal activity	> 99.3% virucidal activity
<b>Environment / indoor air quality</b>				
TVOC after 28 days	ISO 16000-6	microgram/m <sup>3</sup>	< 10	< 10
Certification	-	-	Floorscore®	Floorscore®
<b>CE marking</b>				



EN 14041



(1) The implementation of an effective cleaning regime is the most important defence against infection.



# Taralay Multilayered

## Taralay Initial - Wood

 Compact
  Acoustic
 19 dB
  Protectsol®
  100% recyclable



0826 Filament Grey

### Filament



0826 Filament Grey



No plank  
Continuous design



0799 Filament Light



No plank  
Continuous design

### Renzo



0590 Renzo Steel



No plank  
Continuous design

### Esterel



0636 Esterel Blond



10 cm

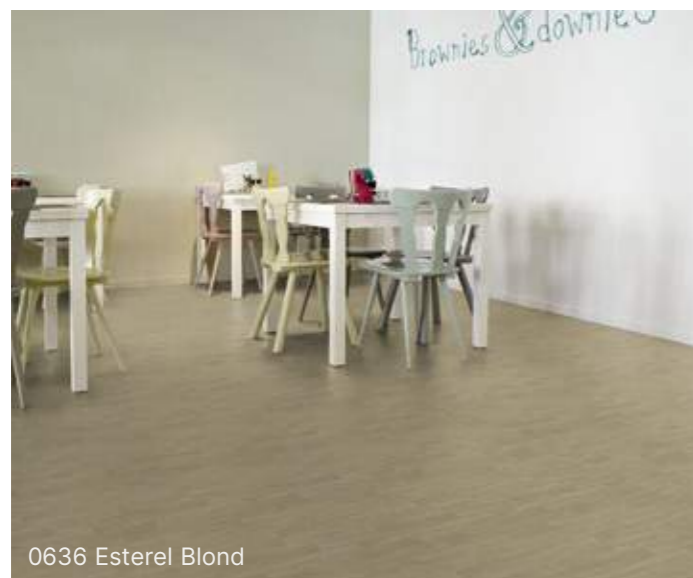

0636 Esterel Blond



0828 Habana Beige

### Habana



0797 Habana Ivory



16.7 cm



0828 Habana Beige



16.7 cm



0698 Noma Naturel

### Noma



0588 Noma Clair



16.7 cm



0698 Noma Naturel



16.7 cm



# Taralay Multilayered

## Taralay Initial - Wood

 Compact
  Acoustic
 19 dB
  Protectsol®
  100% recyclable



0773 Ranch

### Ranch



0773 Ranch   16.7 cm 



0953 Ranch Anthracite   16.7 cm 

### Bostonian



0961 Bostonian Honey   20 cm 



0959 Bostonian Brown   20 cm 

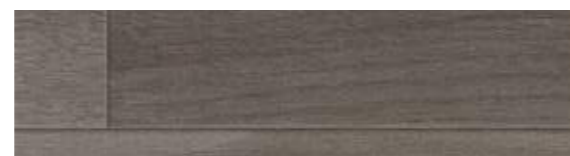

0960 Bostonian Grey   20 cm 



0977 Twist Grey

### Twist



0977 Twist Grey   16.7 cm 



0979 Twist White   16.7 cm 



0978 Twist Blond   16.7 cm 



0980 Twist Brown   16.7 cm 

Design name	Colour Reference	Colour Name	Pattern Repeat in m	Planks Sizes in cm	
				Length	Width
Bostonian	0959	Brown	1 m x 1 m	100	20
Bostonian	0960	Grey	1 m x 1 m	100	20
Bostonian	0961	Honey	1 m x 1 m	100	20
Esterel	0636	Blond	1 m x 1 m	100	10
Habana	0828	Beige	1 m x 1 m	100	16.7
Habana	0638	Ivory	1 m x 1 m	100	16.7
Noma	0588	Clair	1 m x 1 m	100	16.7
Noma	0698	Naturel	1 m x 1 m	100	16.7
Ranch	0773	Ranch	1 m x 1 m	100	16.7
Ranch	0953	Ranch Anthracite	1 m x 1 m	100	16.7
Twist	0978	Blond	1 m x 1 m	100	16.7
Twist	0980	Brown	1 m x 1 m	100	16.7
Twist	0977	Grey	1 m x 1 m	100	16.7
Twist	0979	White	1 m x 1 m	100	16.7



# Taralay Multilayered

Taralay Initial - Urban / Strada



 19 dB **Protecsol®**  100% recyclable



## Urban

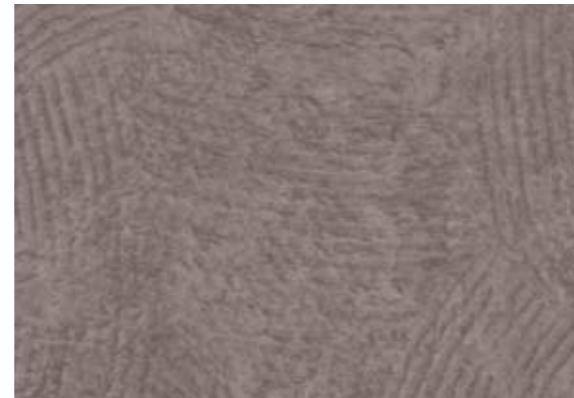

0035 Urban Gris ^ Scale 1



0037 Urban Souris

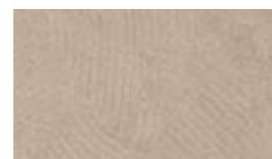

0958 Urban Beige



## Strada



0791 Strada Metallic ^ Scale 1



0790 Strada Chrome



0465 Strada Ciment



# Taralay Initial - Spider



0974 Spider Saphir ^ Scale 1



0976 Spider Quartz



0954 Spider Dore



0956 Spider Grenat



0957 Spider Cuivre



0975 Spider Emeraude



0955 Spider Perle



0973 Spider Alu





# Taralay Multilayered

## Taralay Initial - Diversion



 19 dB Protecsol®  100% recyclable



0515 Diversion Kiwi



0515 Diversion Kiwi ^ Scale 1



0949 Diversion Soleil



0825 Diversion Turquoise



0049 Diversion Carbone



0962 Diversion Marine



0047 Diversion Ivoire



0824 Diversion Souris



## Taralay Initial - Miami



0952 Miami Soleil

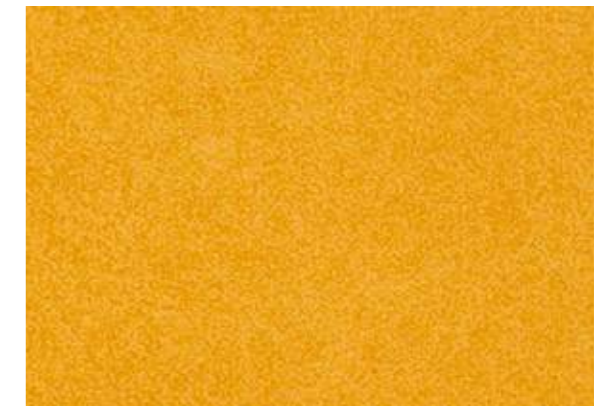

0952 Miami Soleil ^ Scale 1



0950 Miami Sable



0963 Miami Perle



0966 Miami Abricot



0968 Miami Ciel



0951 Miami Litchee



0967 Miami Mer



0970 Miami Taupe



0965 Miami Foret



0964 Miami Souris



0969 Miami Paon





# Taralay Multilayered

## Nerok 55/70

Nerok 55/70

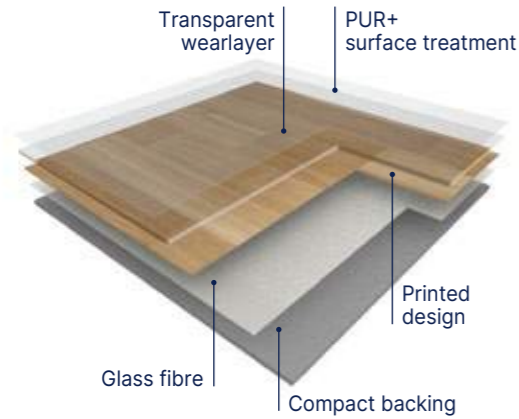

**NEROK** is a multilayered vinyl floor covering available in 2m and 4m wide sheet, with a group T wear rating.

The product comprises a compacted backing reinforced with a glass fiber veil and a printed design that is protected by a transparent wearlayer. It offers a -6 dB sound insulation and a resistance to indentation of 0.05 mm.

This flooring is protected by the surface treatment, **PUR+ MAT**, ensuring easy maintenance and no required polish for the entire lifetime of the product.

It does not contain any heavy metals or CMR 1&2 components, 100% compliant with REACH. The product emission rate of volatile organic compounds is <100 microgram/m<sup>3</sup> (TVOC after 28 days ISO 16000-6).

It is 100% recyclable.



• Available in 4 and 2m width

• Nerok 55: Class 33

• Nerok 70: Class 34

• 100 % Recyclable

• **PUR+** Polyurethane surface treatment:  
- Easy maintenance



0476 Noma Miel

	Nerok 55	Nerok 55 Acoustic	Nerok 70	Nerok 70 Acoustic
<b>Description</b>				
Total Thickness	EN ISO 24346	mm	2.00	3.35
Thickness of the wearlayer	EN ISO 24340	mm	0.55	0.55
Weight	EN ISO 23997	g/m <sup>2</sup>	2560	2400
Width of sheet	EN ISO 24341	cm	200 /400	200 /400
Length of sheet	EN ISO 24341	ml	20	20
<b>Classification</b>				
Norm/Product Specification	-	-	EN ISO 10582	EN ISO 11638 (EN 651)
European Classification	EN ISO 10874	Class	33-42	33-42
Fire Rating	EN 13501-1	Class	Bfl-s1	Bfl-s1
Static Electrical Propensity	EN 1815	kV	< 2	< 2
Slip Resistance Wet	EN 16165:2021 – Appendix B (DIN 51 130)	Class	R10	R10
<b>Performances</b>				
Wear Resistance	EN 660.2	mm <sup>3</sup>	≤ 2.0	≤ 2.0
Wear Group	QB 30	group	T	T
Type Binder content	EN ISO 10582	type	I	-
Dimensional stability (norm)	EN ISO 23999	%	≤ 0.40	≤ 0.40
Residual Indentation	EN ISO 24343-1	mm	≤ 0.10	≤ 0.20
Residual Indentation (average measured value)	-	mm	≈ 0.05	≈ 0.10
Impact sound insulation	EN ISO 717-2	dB	6	19
Castor chair test (type H)	ISO 4918	-	OK	OK
Thermal Conductivity	EN ISO 10456	W/(m.k)	0.25	0.25
Colour Fastness	EN ISO 105-B02	degree	≥ 6	≥ 6
Surface Treatment	-	-	PUR+	PUR+
Chemical Products Resistance <sup>(1)</sup>	EN ISO 26987	-	OK	OK
<b>Environment/indoor air quality</b>				
TVOC after 28 days	ISO 16000-6	micrograms/m <sup>3</sup>	<100	<100
Certification	-	-	Floorscore®	Floorscore®
<b>CE marking</b>				



EN 14041



(1) Regarding the resistance to chemicals, please download the corresponding leaflet from our website.



# Taralay Multilayered

Nerok 55/70



19 dB

PUR+



100% recyclable



2013 Sherwood Blond

## Sherwood



2015 Sherwood Brown



25 cm



2013 Sherwood Blond



25 cm



2012 Sherwood Clear



25 cm



2017 Sherwood Grey



25 cm

## Newport



2244 Newport Clear



20 cm



2245 Newport Natural



20 cm



1893 Harbor Blue

## Harbor



1893 Harbor Blue



Multisizes

## Noma



0476 Noma Miel



16.7 cm



1451 Noma Kola



16.7 cm

## Oak Select



2242 Oak Select Country



No strip  
Continuous design



1430 Oak Select Dark Grey



No strip  
Continuous design



# Taralay Multilayered

Nerok 55/70

 Compact
  Acoustic
 19 dB PUR+
  100% recyclable



1751 Timber Grey

## Timber



1751 Timber Grey



16.7 cm



0720 Timber Clear



16.7 cm



0492 Timber Cabana



16.7 cm

## Chene



0669 Chene Light



6.2 cm

## Factory



1518 Factory White



16.7 cm



2151 Shade Light Grey

## Shade



2151 Shade Light Grey



^ Scale 1



2152 Shade Grey



2153 Shade Anthracite



2249 Brooklyn Blue

## Brooklyn



2249 Brooklyn Blue



^ Scale 1



2253 Brooklyn Silver





# Taralay Multilayered

Nerok 55/70

Compact 6 dB PUR+ 100% recyclable



2131 Leone Mouse

## Leone



2131 Leone Mouse ^ Scale 1

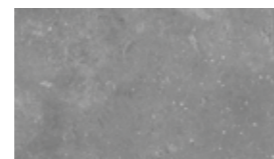

2132 Leone Metal

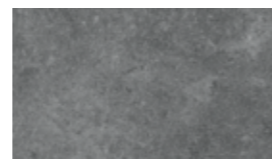

2133 Leone Anthracite



2135 Leone Cream



2134 Leone Brown



0597 Pixel Silver

## Pixel



0597 Pixel Silver ^ Scale 1



2176 Pixel Taupe

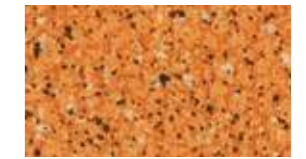

2178 Pixel Paprika



2175 Pixel Clear



0621 Pixel Vanilla



0639 Pixel Sand

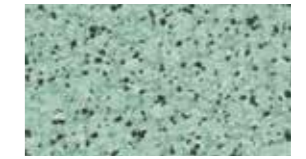

2181 Pixel Meadow



0632 Pixel Anthracite

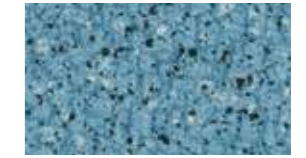

2182 Pixel Ocean

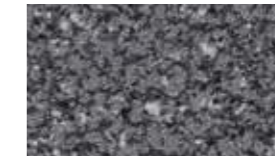

2179 Pixel Black





# Taralay Multilayered

## Tarastep Pro

Tarastep Pro

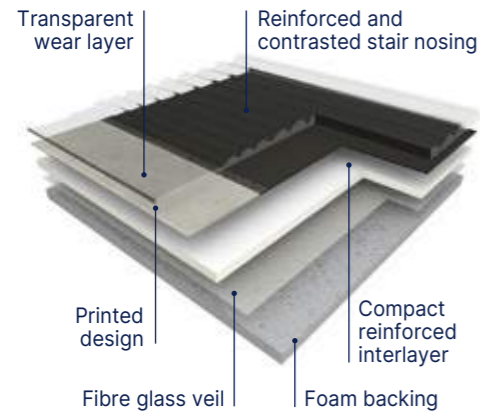

**TARASTEP PRO** is an **heterogenous, sound-absorbing** solution with reinforced layer and transparent wearlayer, used to **recover indoor stairs in a single element**.  
**TARASTEP PRO is an all-in-one** covering that covers the tread, the stair nosing - with a reinforced non-slip surface, and the riser. It has a total thickness of 3.45 mm, with a **wear layer of 1 mm** which gives it great resistance to traffic and a residual indentation of 0.10 mm (value measured).  
 With a high-density foam backing, TARASTEP PRO provides 17dB of sound insulation and 63dB of walking noise.  
**It complies with accessibility regulations.** The stair nosing specially designed to facilitate movement presents a **tactile contrast and a visual contrast** of at least 70% on each color.  
**TARASTEP PRO** is suitable for premises classified **34/42 European class**.  
 According to standard NF EN 13501-1, the coating is classified Bfls1. It is phthalate-free and complies with the European REACH regulation. TVOC air emissions at 28 days (NF EN 16000) of the selected coating are < 100 µg / m<sup>3</sup>. It is 100% recyclable.



- **Complete solution for stairs** : more durable
- **Concrete design with 70% minimum contrast** with stair nose
- **Mix & match with Taralay and Premium ranges** : colors harmony stair & floor
- **High thickness** : comfort underfoot
- **1 mm wearlayer** : high resistance to traffic

Tarastep Pro

Description			
Total thickness	EN ISO 24346	mm	3.45
Thickness of wearlayer	EN ISO 24340	mm	1
Weight	EN ISO 23997	g/sqm	3005
Width of sheet	EN ISO 24341	cm	100
Length of sheet	EN ISO 24341	lm	20
Classification			
Norm / Product specification	-	-	EN ISO 11638
European classification	EN ISO 10874	class	34-42
Impact sound insulation	EN ISO 717-2	dB	17
Walking sound	NFS 31 074	dB	< 65
Fire rating	EN 13501-1	class	Bfl-s1
Static electrical propensity	EN 1815	kV	< 2
Slip Resistance Wet	EN 16165:2021 – Appendix B (DIN 51 130)	classe	R10
Performances			
Wear resistance	EN 660.2	mm <sup>3</sup>	≤ 2.0
Wear group	-	group	T
Dimensional stability	EN ISO 23999	%	≤ 0.40
Residual indentation (requirement)	EN ISO 24343-1	mm	≤ 0.20
Residual indentation (average measured value)	-	-	≈ 0.10
Thermal conductivity	EN ISO 10456	W/(m.k)	0.25
Colour fastness	EN ISO 105-B02	degree	≥ 6
Surface Treatment	-	-	Protecsol®
Chemical products resistance <sup>(1)</sup>	EN ISO 26987	-	OK
Anti-bacterial activity (E. coli - S. aureus - MRSA) <sup>(2)</sup>	ISO 22196	-	> 99% inhibits growth
Anti-viral activity (human coronavirus) after 2h <sup>(2)</sup>	ISO 21702	-	> 99.3% virucidal activity
Environment / indoor quality air			
TVOC after 28 days	ISO 16000-6	microgram/m <sup>3</sup>	< 100
Certification	-	-	Floorscore®
CE marking			

Access for all (More details - See page 389)

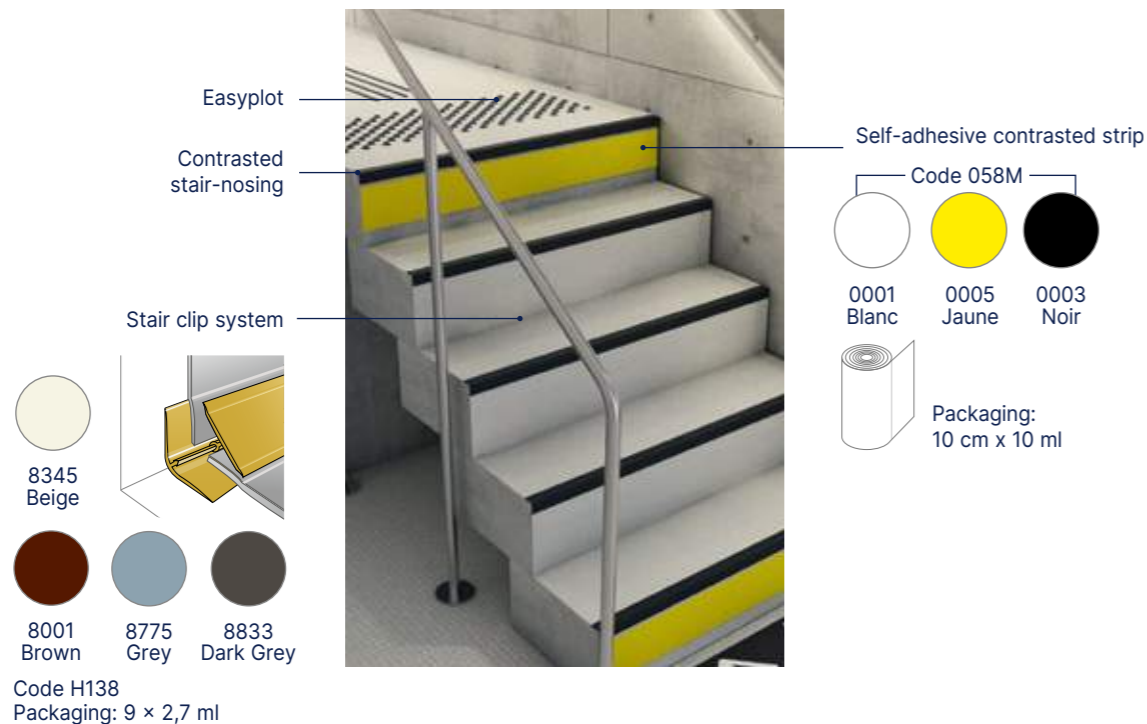

EN 14041



(1) Regarding the resistance to chemicals, please download the corresponding leaflet from our website.  
 (2) The implementation of an effective cleaning regime is the most important defence against infection.



# Taralay Multilayered

## Tarastep Pro



17 dB



100% recyclable

**CUTTING SERVICE AVAILABLE**

**CUTTING SERVICE AVAILABLE**

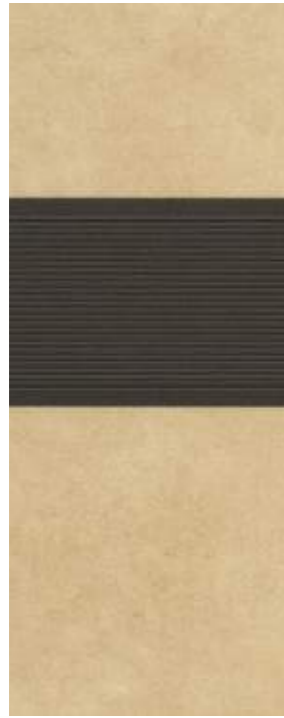

2338 Sand & Brown  
82% contrast

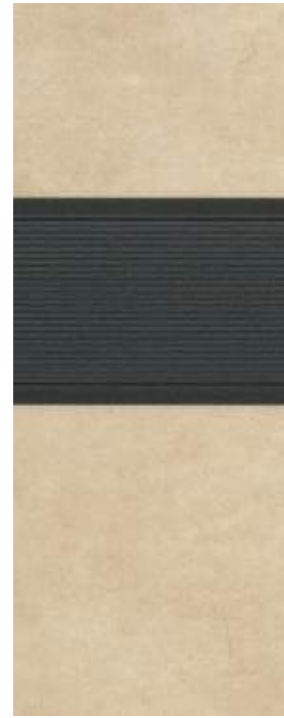

2333 Nature & Dark Grey  
83% contrast



2335 Capri & Black  
79% contrast

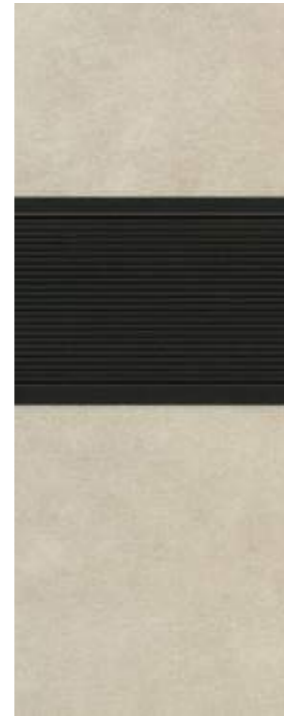

2342 Genova & Dark Grey  
90% contrast

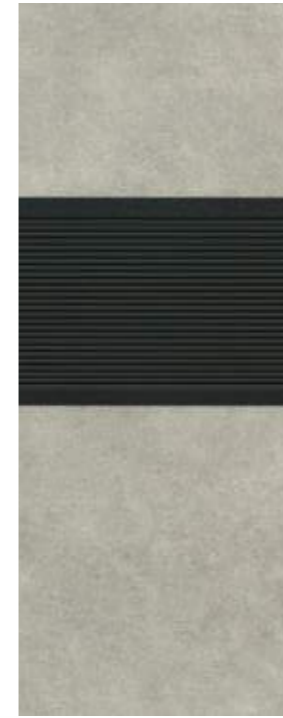

2336 Brescia & Black  
84% contrast



2343 Light Grey & Black  
85% contrast



2341 Black & Light Grey  
77% contrast



2332 Silver & Dark Grey  
86% contrast



2339 Dark Grey & Yellow  
73% contrast



2334 Blue Grey & Clear  
73% contrast



2337 Deep Blue & Clear  
77% contrast



2344 Silver & Green  
73% contrast

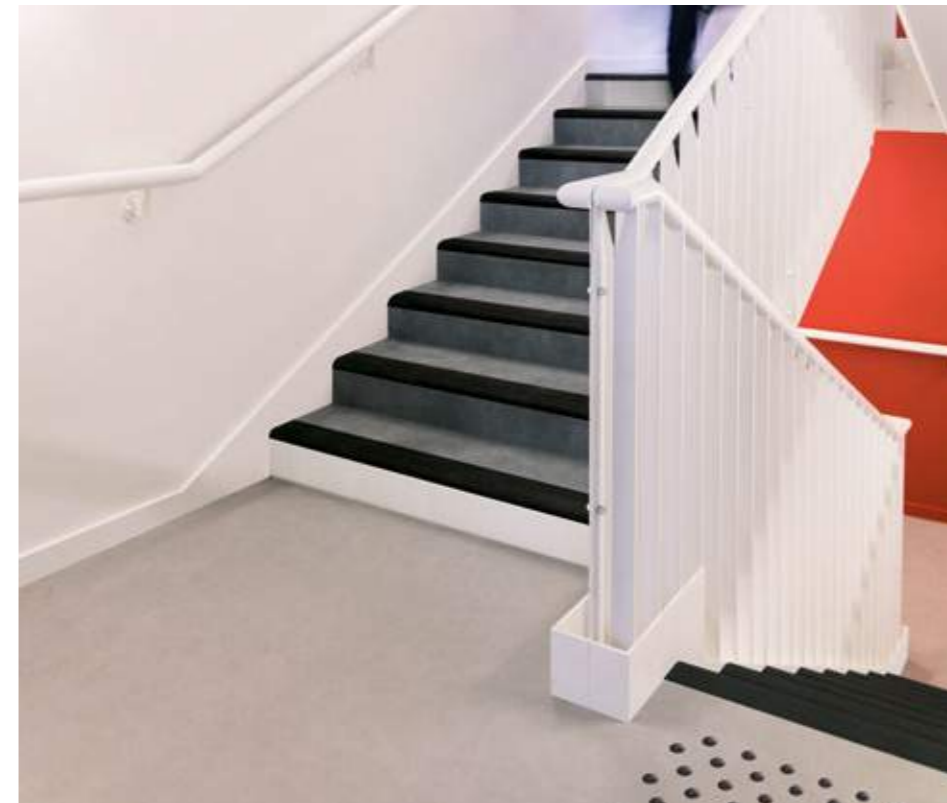

2340 Warm Grey & Black  
77% contrast



European Creation Tiles & planks  
manufacturer since 1985

- 4 Creation Tiles & planks  
factories
- Stock in Europe  
12 logistics hubs
- Internal Design Center  
> exclusive designs

**Gerflor**  
**The Reference!**

## Creation Tiles & planks

pages 124-227

### 130. **Creation 70**

- 130. Creation 70
- 132. Creation 70 Clic
- 134. Creation 70 Looselay **New**
- 136. Creation 70 Connect

### 160. **Creation Saga<sup>2</sup> **New****

### 166. **Creation 55**

- 166. Creation 55
- 168. Creation 55 Solid Clic
- 170. Creation 55 Rigid Acoustic
- 172. Creation 55 Looselay **New**
- 174. Creation 55 Looselay Acoustic **New**

### 196. **Creation 40**

- 196. Creation 40
- 198. Creation 40 Solid Clic
- 200. Creation 40 Rigid Acoustic

### 210. **Creation 30**

- 210. Creation 30
- 212. Creation 30 Solid Clic

### 224. **My Creation My Saga<sup>2</sup>**

### 227. **More than a floor... wall & finishes**



# Creation Tiles & planks

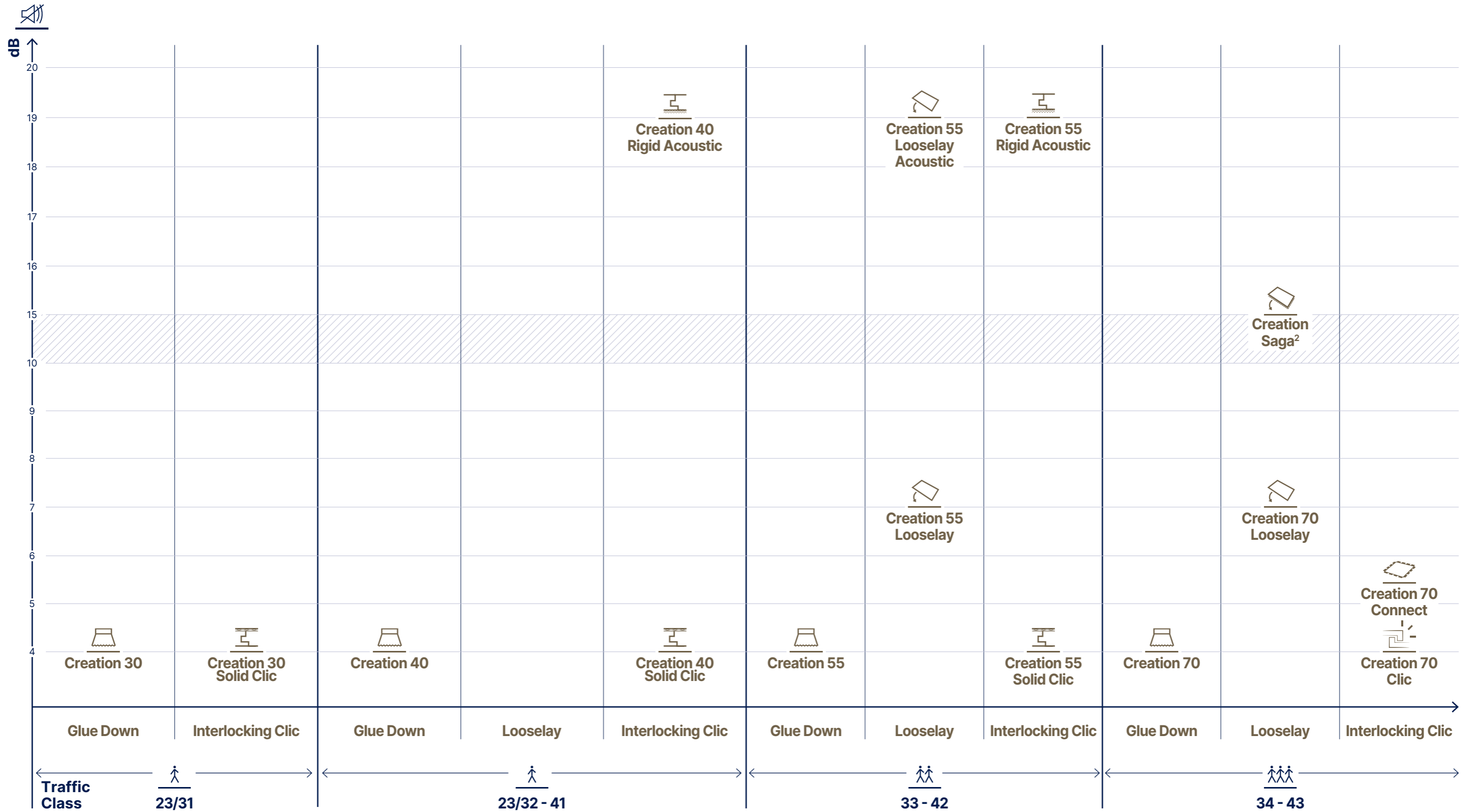

Visualize your design in any room setting on [gerflor.com](https://www.gerflor.com) > Services > Interior Designer



# Our Commitments

for a Sustainable future

All Gerflor product ranges are developed according to a life cycle analysis model

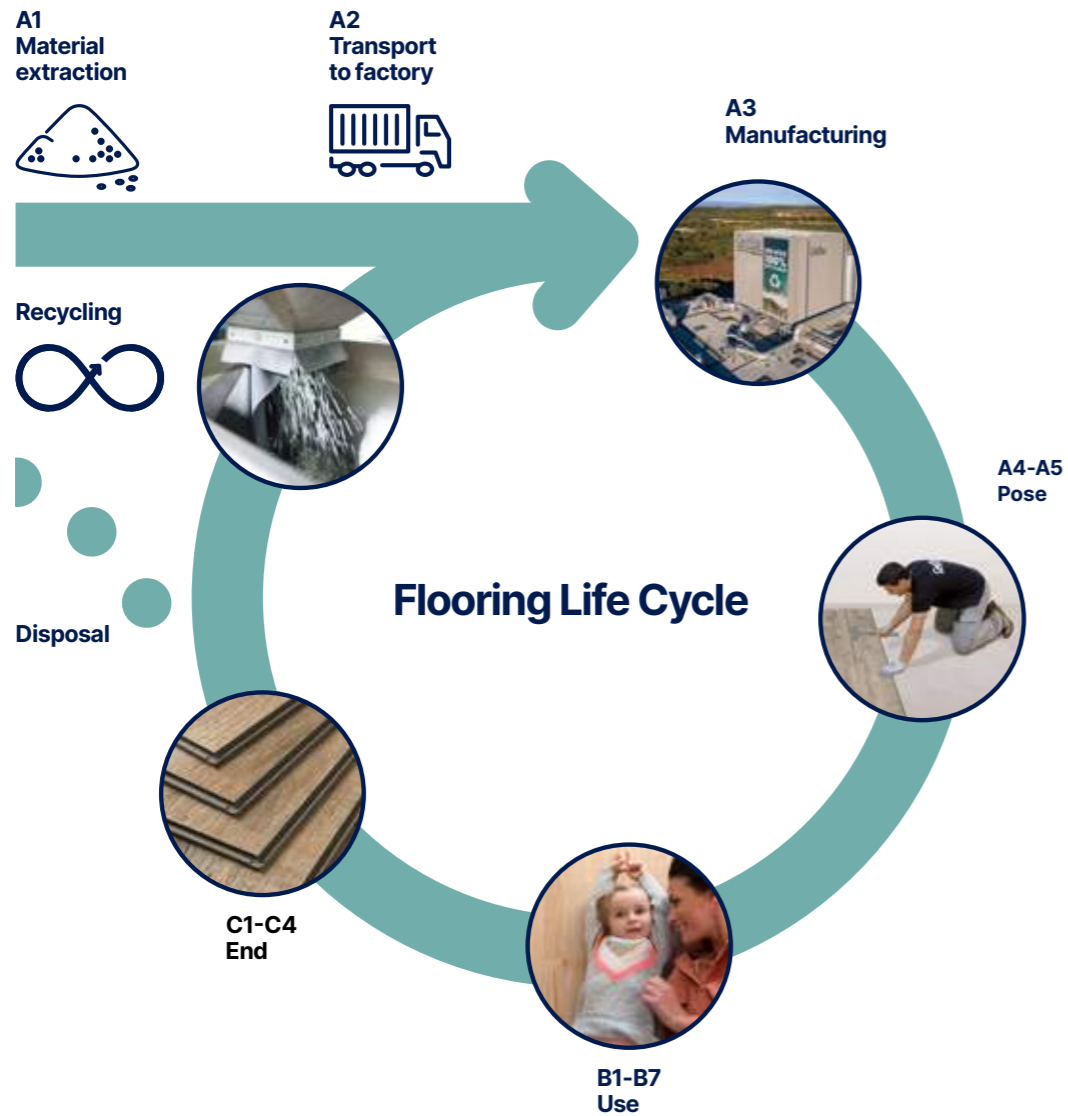

Third-party verified life cycle analysis of our products can be found in their Environmental Product Declaration (EPD)

# Creation

the reference in sustainability



## Carbon footprint

- Manufacturing Footprint in Europe
- ISO 14001 & 50001 certifications
- Renewable energy



## 3 factories in Europe

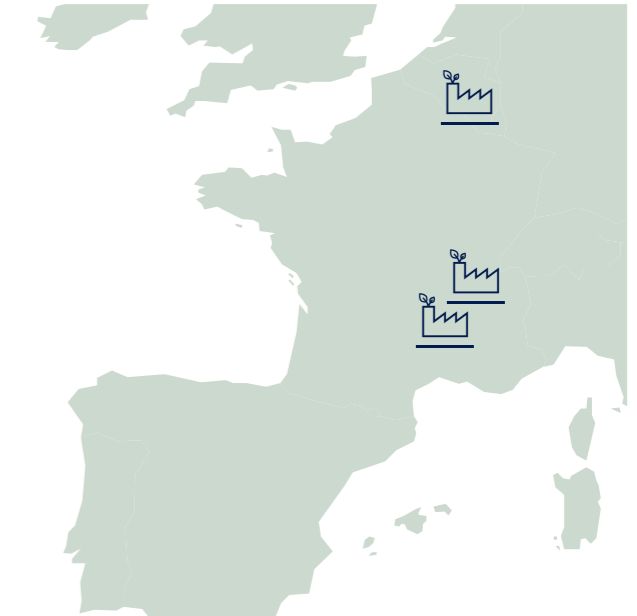

## Circularity

- 100% recyclable products
- High % of recycled content
- Adhesive Free solutions
- Packaging using 100% recycled cardboard



## Health and safety

- 100% Reach compliant
- Phthalate free\*
- Formaldehyde Free
- Indoor Air Quality: TVOC <10 µg/m3 after 28 days

\*Except recycled content



**We care / We act**



# Creation Tiles & planks

## Creation 70

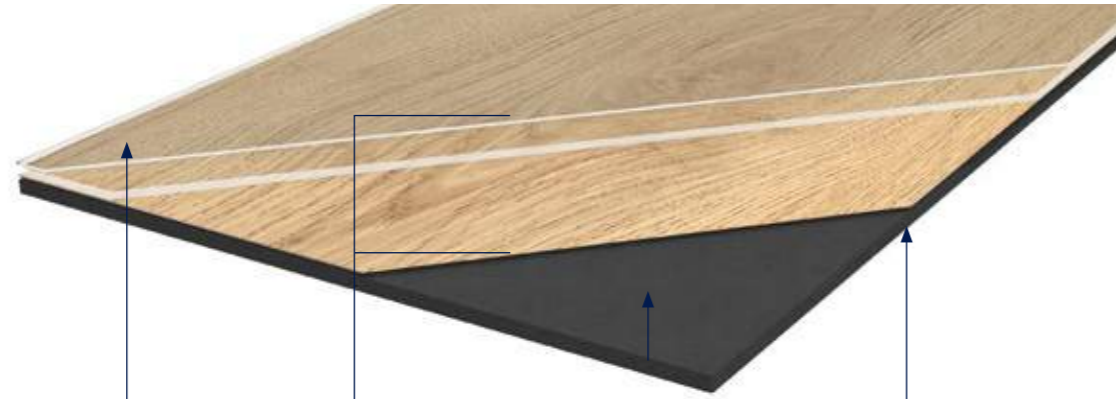
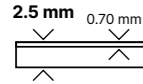

### PUR+ MATT



Easy maintenance

### 4D DESIGN

#### MATT SURFACE



Natural look

#### CRISTAL WEAR LAYER



High definition design & color

#### STRUCTURED EMBOSS & BEVEL



Ultra realistic surface

#### DESIGNS



Wide variety of planks or tiles

### RESILIENT COMFORT CORE



Noise absorption



Soft underfoot

### DIAMOND BACKLAYER

#### BODY & STRENGTH



Easy handling

#### BACK EMBOSS



Better subfloor adhesion

Easy positioning

## Creation Tiles & planks decoratives strips

Format (mm) 4×914mm



Code: 3203 + Color code



100% reach phthalate free



100% recyclable  
Up to 35% recycled content



TVOC emissions below detection level  
(TVOC < 10µg/m³ after 28 days)  
No formaldehyde

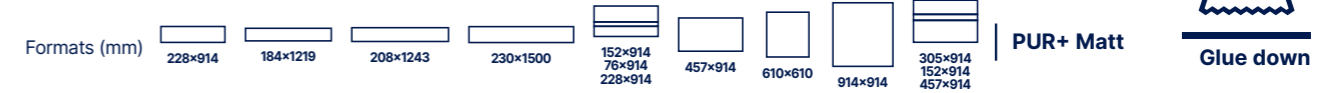

## Creation 70

**Creation 70 Design** is a synthetic, decorative, flexible, antistatic abrasion group T floorcovering available in tile or plank, with beveled edges. It consists in a 0.70 mm thick transparent wear layer, a design film and a Resilient Comfort Core to provide softness and comfort surface. The overall thickness is 2.5 mm. It benefits from a cross-linked polyurethane surface treatment (**PUR+ Matt**), making maintenance easier and eliminating the need for initial polishes.

**Creation 70 Design** is a glued floorcovering, resistant to use (commercial / industrial use) of 34-43 according to EN-ISO 10874 and has Bfl-s1 class for smoke emission according to EN 13501-1.

**Creation 70 Design** is made with phthalate free plasticizers, except recycled content. It is 100% recyclable and made with 35% of recycled content. It is REACH compliant. **The product emission rate of organic compounds is < 10 microgram/m³** (TVOC < 28 days – ISO 16000-6).



### Creation 70

	Creation 70 Design										Creation 70	
<b>Description</b>												
Total thickness	EN ISO 24346	mm									2.50	2.50
Thickness of wearlayer	EN ISO 24340	mm									0.70	0.70
Weight	EN ISO 23997	g/sqm									4100	3960
Size	EN ISO 24342	mm	184x1219	230x1500	Mix planks 76/152/ 228x914	610x610	914x914	457x914	228x914	Mix tiles 152/305/ 457x914	208x1243	
Number of planks / tiles and sqm per box	-	-	14 <sup>(1)</sup> / 15 3.14 / 3.36	9 / 3.11	8+8+8 / 3.34 m	9 / 3.35	5 / 4.18	9 / 3.76	17 / 3.54	4+4+4 / 3.34	14 / 3.62	
<b>Classification</b>												
Norm / Product specification	-	-							EN ISO 10582	EN ISO 10582		
European classification	EN ISO 10874	class							34-43	34-43		
Fire rating	EN 13501-1	class							Bfl-s1	Bfl-s1		
Static electrical propensity	EN 1815	kV							< 2	< 2		
Slip resistance wet <sup>(2)</sup>	EN 16165:2021 – Appendix B (DIN 51 130)	class							R10	R10		
<b>Performances</b>												
Wear resistance	EN 660.2	mm³							≤ 2.0	≤ 2.0		
Wear group	-	group							T	T		
Type Binder content	ISO 10582	type							I	I		
Room impact	NF S 31074	dB							76	76		
Sound Insulation	EN ISO 717-2	dB							4	4		
Dimensional stability (norm)	EN ISO 23999	%							≤ 0.25	≤ 0.25		
Dimensional stability (average measured value)	-	%							≤ 0.10	≤ 0.10		
Residual indentation	EN ISO 24343-1	mm							≤ 0.10	≤ 0.10		
Castor chair test (type H)	ISO 4918	-							OK	OK		
Thermal conductivity	EN ISO 10456	W/(m.k)							0.25	0.25		
Colour fastness	EN ISO 105-B02	degree							≥ 6	≥ 6		
Surface treatment	-	-							PUR+ Matt	PUR+ Matt		
Chemical products resistance	EN ISO 26987	-							OK	OK		
<b>Environment / indoor air quality</b>												
TVOC after 28 days	ISO 16000-6	microgram/m³							< 10	< 10		
<b>CE marking</b>												



EN 14041



(1) Regimental Picadilly 0807  
(2) Ramp test with oil



# Creation Tiles & planks

## Creation 70 Clic

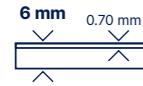

### PUR+ MATT



Easy maintenance

### 4D DESIGN

#### MATT SURFACE



Natural look

#### CRYSTAL WEAR LAYER



High definition design & color

#### STRUCTURED EMOSS & BEVEL



Ultra realistic surface

#### 2 M PATTERN DESIGN

Wide variety of planks or tiles

### DUOCORE TECHNOLOGY

#### RESILIENT COMFORT CORE



Noise absorption



Soft underfoot

#### RIGID CORE WITH FIBER GLASS VEIL



The best stability



No adhesive



Renovation ceramic 4 mm joint

### CLIC REVOLUTION 100 % VERTICAL



30% Faster



Durable clic system



Heavy load resistance



Waterproof joints



Easy to change a plank



100% Reach Phthalate free



100% Recyclable Up to 55% recycled content



TVOC emissions below detection level (TVOC < 10µg/m³ after 28 days) No formaldehyde

Formats (mm)

212x1239

242x1461

391x729

PUR+ Matt



## Creation 70 Clic

**Creation 70 Clic** is a synthetic, decorative, flexible, antistatic, abrasion group T floorcovering available in tiles and planks, with bevelled edges. It consists in a 0.70 mm thick transparent wear layer, a design film of 2 m width to have more variety in the design and a Duo Core Technology, made with a rigid core back layer reinforced with a fiber veil, combined with a flexible core top layer to provide softness and comfort surface. The overall thickness is 6 mm. They benefit from a cross-linked polyurethane surface treatment (**PUR+ Matt**), making maintenance easier and eliminating the need for initial polishes.

**Creation 70 Clic** is an interlocking floorcovering assembled with a vertical system on the long and short side for a quick and solid installation. The resistance to use (commercial / industrial use) of 34-43 according to EN-ISO 10874 and has Bfl -s1 class for smoke emission according to EN 13501-1. **Creation 70 Clic** is made with phthalate free plasticizers, except recycled content. It is 100% recyclable and made with 55% of recycled content. It is REACH compliant. **The product emission rate of organic compounds is < 10 microgram/m³** (TVOC < 28 days - ISO 16000-6).

To be combined with Gerflor acoustic underlayers

Gerflor Acoustic 15dB



Code: 1798 - Format: 1m x 15ml

Please refer to Gerflor's installation guidelines.

Romus Tools

Anti-bounce mallet / Fitter Knife - Creation Tiles & planks Roller



### Creation 70 Clic

#### Description

Total thickness	EN ISO 24346	mm	6		
Thickness of wearlayer	EN ISO 24340	mm	0.70		
Weight	EN ISO 23997	g/sqm	9850		
Size	EN ISO 24342	mm	214 × 1239	242 × 1461	391 × 729
Number of planks / tiles and sqm per box	-	-	6 / 1.59	5 / 1.77	5 / 1.43

#### Classification

Norm / Product specification	-	-	EN ISO 10582		
European classification	EN ISO 10874	class	34-43		
Fire rating	EN 13501-1	class	Bfl-s1		
Static electrical propensity	EN 1815	kV	< 2		
Slip resistance wet: ramp test with oil	EN 16165:2021 - Appendix B (DIN 51 130)	class	R10		

#### Performances

Wear resistance	EN 660.2	mm³	≤ 2.0		
Wear group	-	group	T		
Type Binder content	ISO 10582	type	I		
Dimensional stability (norm)	EN ISO 23999	%	≤ 0.15		
Dimensional stability (average measured value)	-	%	≤ 0.05		
Residual indentation	EN ISO 24343-1	mm	≤ 0.10		
Impact sound insulation	EN ISO 717-2	dB	5		
Room impact	NF S 31074	dB	78		
Castor chair test (type H)	ISO 4918	-	OK		
Thermal conductivity	EN ISO 10456	W/(m.k)	0.25		
Colour fastness	EN ISO 105-B02	degree	≥ 6		
Surface treatment	-	-	PUR+ Matt		
Chemical products resistance	EN ISO 26987	-	OK		

#### Environment / indoor air quality

TVOC after 28 days	ISO 16000-6	microgram/m³	< 10		
--------------------	-------------	--------------	------	--	--

#### CE marking



EN 14041





# Creation Tiles & planks

## Creation 70 Looselay **New**

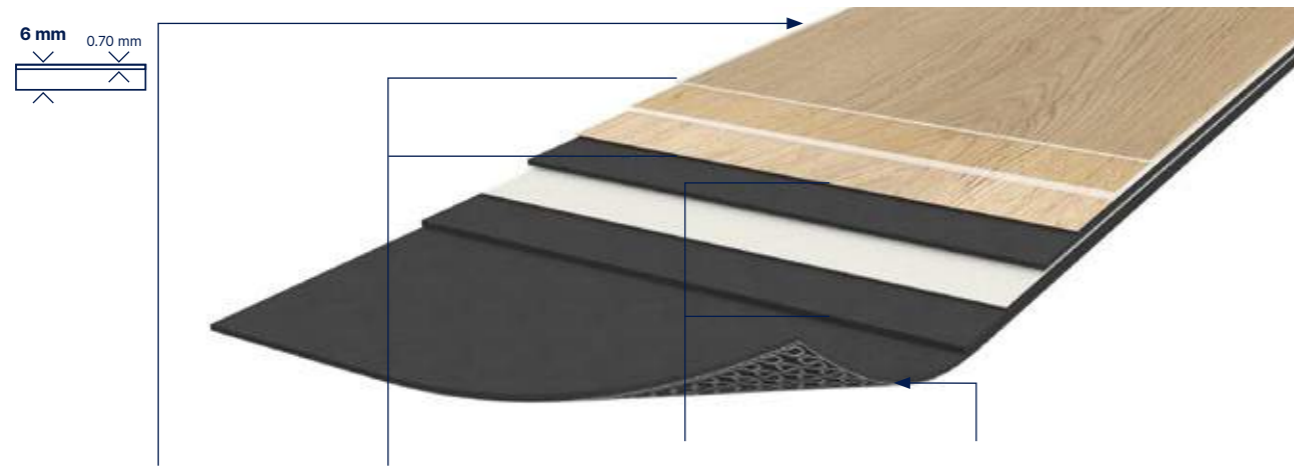

### PROTECSHIELD™ 4D DESIGN



Easy maintenance

#### MATT SURFACE



Natural look

#### CRISTAL WEAR LAYER



High definition design & color

#### STRUCTURED EMOSS & BEVEL



Ultra realistic surface

#### MIX&MATCH DESIGNS



Easy mix&match of designs & formats

### DUOCORE TECHNOLOGY

#### RESILIENT COMFORT CORE



Noise absorption



Soft underfoot

#### RIGID CORE



The best stability / Fiber glass inside



Renovation ceramic < 5 mm joint

### GRIP-WAVE BACKLAYER

#### ANTI-SKID BACKING



Super strong suction to the subfloor

Air circulation: better acoustic

Humidity circulation: moisture resistance



Easily removable: renovation



100% Reach Phthalate free



100% Recyclable Up to 35% recycled content



TVOC emissions below detection level (TVOC < 10µg/m³ after 28 days) No formaldehyde

Formats (mm)



Protecshield™



Looselay Removable

## Creation 70 Looselay

**Creation 70 Looselay** is a synthetic, decorative, flexible, antistatic, abrasion group T floorcovering available in tiles and planks, with bevelled edges. It consists in a 0.70 mm thick transparent wear layer, a design film and a Duo Core Technology, made with a rigid core back layer reinforced with a fiber veil, combined with a flexible core top layer to provide softness and comfort surface. The overall thickness is 6 mm. It also includes anti-skid backing to allow an easy installation. It benefits from a cross-linked polyurethane surface treatment (**PUR+ Matt**), making maintenance easier and eliminating the need for initial polishes.

**Creation 70 Looselay** is a looselay floorcovering, resistant to use (commercial / industrial use) of 34-43 according to EN-ISO 10874 and has Bfl-s1 class for smoke emission according to EN 13501-1.

**Creation 70 Looselay** is made with phthalate free plasticizers, except recycled content. It is 100% recyclable and made with 35% of recycled content. It is REACH compliant.

**The product emission rate of organic compounds is < 10 microgram/m³ (TVOC < 28 days – ISO 16000-6).**

## Explore the world of possibilities

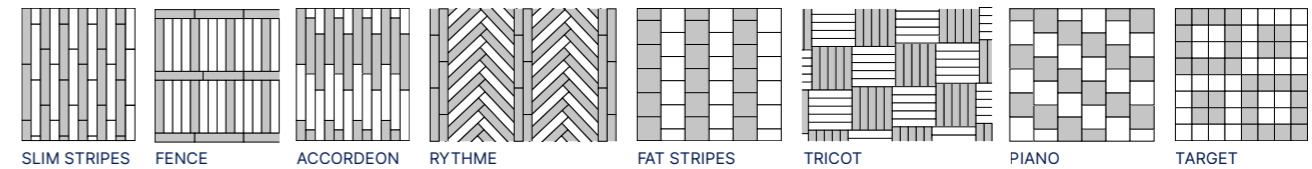

## Quick & easy to install



Installation with tackifier

Apply planks or tiles

Pressure roller

Easy to replace a plank

Please refer to Gerflor's installation guidelines.

### Creation 70 Looselay

#### Description

Total thickness	EN ISO 24346	mm	5.00
Thickness of wearlayer	EN ISO 24340	mm	0.70
Weight	EN ISO 23997	g/sqm	8300
Size	EN ISO 24342	mm	235x1505 228.6x1220 152.4x914.4 600x600 914.4x914.4
Number of planks / tiles and sqm per box	-	-	4 / 1.41 sqm 6 / 1.67 sqm 12 / 1.67 sqm 4 / 1.44 sqm 4 / 3.34 sqm

#### Classification

Norm / Product specification	-	-	EN ISO 10582
European classification	EN ISO 10874	class	34-43
Fire rating	EN 13501-1	class	Bfl-s1
Static electrical propensity	EN 1815	kV	< 2
Slip resistance wet: ramp test with oil	EN 16165:2021 – Appendix B (DIN 51 130)	class	R10

#### Performances

Wear resistance	EN 660.2	mm³	≤ 2.0
Wear group	-	group	T
Type Binder content	ISO 10582	type	I
Room impact	NF S 31074	dB	74
Impact sound insulation	EN ISO 717-2	dB	7
Dimensional stability (norm)	EN ISO 23999	%	≤ 0.15
Dimensional stability (average measured value)	-	%	≈ 0.05
Residual indentation	EN ISO 24343-1	mm	≤ 0.10
Castor chair test (type H)	ISO 4918	-	OK
Thermal conductivity	EN ISO 10456	W/(m.k)	0.25
Colour fastness	EN ISO 105-B02	degree	≥ 6
Surface treatment	-	-	ProtecShield™
Chemical products resistance	EN ISO 26987	-	OK

#### Environment / indoor air quality

TVOC after 28 days	ISO 16000-6	microgram/m³	< 10
--------------------	-------------	--------------	------

#### CE marking



EN 14041





# Creation Tiles & planks

## Creation 70 Connect

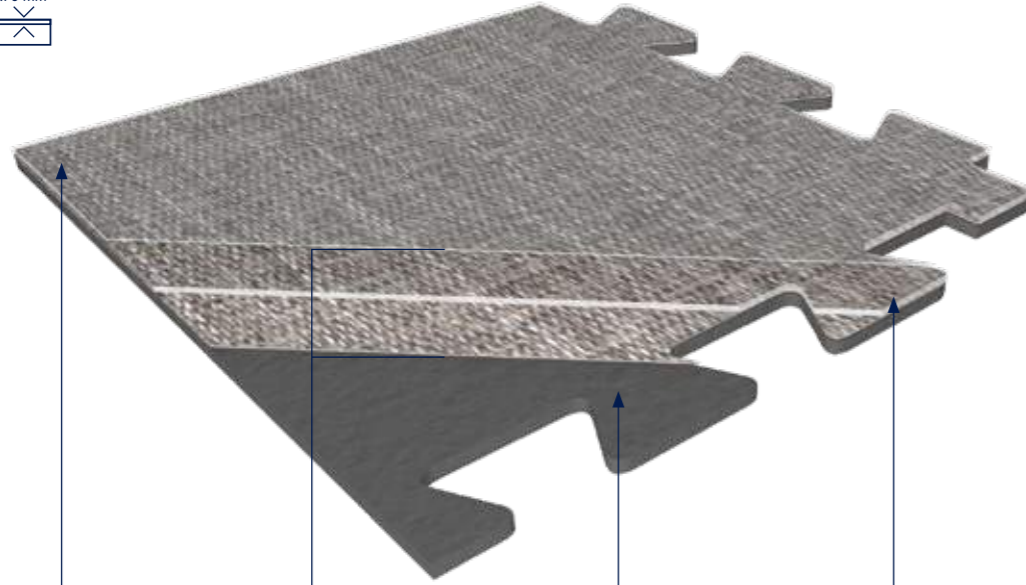
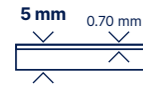

### PUR+ MATT



Easy maintenance

### 4D DESIGN

#### MATT SURFACE



Natural look

#### CRISTAL WEAR LAYER



High definition design & color

#### STRUCTURED EMBOSS



Ultra realistic surface

#### DESIGNS

Designs selected to hide dovetails - all over effect

### RESILIENT REINFORCED CORE



Glass particles for better stability



Noise absorption



Soft underfoot



Renovation ceramic 5 mm joint

### EXCLUSIVE DOVETAILS



Gerflor patented



No adhesive



Easy installation



Avoid mistakes installation



Resistant dovetails

Formats (mm)



PUR+ Matt



Interlocking

## Creation 70 Connect

**Creation 70 Connect** is a synthetic, decorative, flexible, antistatic, abrasion group T floorcovering available in tiles. It consists in a 0.70 mm thick transparent wear layer, a design film, a calendered layer and a PVC compact sublayer reinforced with fibers. The overall thickness is 5 mm. It benefits from a cross-linked polyurethane surface treatment (**PUR+ Matt**), making maintenance easier and eliminating the need for initial polishes.

**Creation 70 Connect** is an interlocking floorcovering, resistant to use (commercial / industrial use of 34-43 according to EN-ISO 10874 and has Bfl-s1 class for smoke emission according to EN 13501-1. **Creation 70 Connect** is made with phthalate free plasticizers, except recycled content. It is 100% recyclable and made with 55% of recycled content. It is REACH compliant. **The product emission rate of organic compounds is < 10 microgram/m³** (TVOC < 28 days - ISO 16000-6).



Interlocking installation with dovetails



Fast and easy renovation



Adhesive free



All over effect



### Creation 70 Connect

#### Description

Total thickness	EN ISO 24346	mm	5.00
Thickness of wearlayer	EN ISO 24340	mm	0.70
Weight	EN ISO 23997	g/sqm	8235
Tile size	EN ISO 24342	mm	701.3 x 701.3
Number of tiles and sqm per box	-	-	20 / 9.83

#### Classification

Norm / Product specification	-	-	EN ISO 10582
European classification	EN ISO 10874	class	34-43
Fire rating	EN 13501-1	class	Bfl-s1
Static electrical propensity	EN 1815	kV	< 2
Slip resistance wet <sup>(1)</sup>	EN 16165:2021 - Appendix B (DIN 51 130)	class	R10

#### Performances

Wear resistance	EN 660.2	mm³	≤ 2.0
Wear group	-	group	T
Type Binder content	ISO 10582	group	I
Room impact	NF-S 31074	dB	75
Impact sound insulation	EN ISO 717-2	dB	5
Dimensional stability	EN ISO 23999	%	≤ 0.15
Residual indentation	EN ISO 24343-1	mm	≤ 0.10
Castor chair test (type H)	ISO 4918	-	OK
Thermal conductivity	EN ISO 10456	W/(m.k)	0.25
Colour fastness	EN ISO 105-B02	degree	≥ 6
Surface treatment	-	-	PUR+ Matt
Chemical products resistance	EN ISO 26987	-	OK

#### Environment / indoor air quality

TVOC after 28 days	ISO 16000-6	microgram/m³	< 10
--------------------	-------------	--------------	------

#### CE marking



EN 14041



(1) Ramp test with oil



# Creation Tiles & planks

Creation 70 Looselay HB 

LL  
Creation 70  
Looselay



Marble Clear / Marble Dark

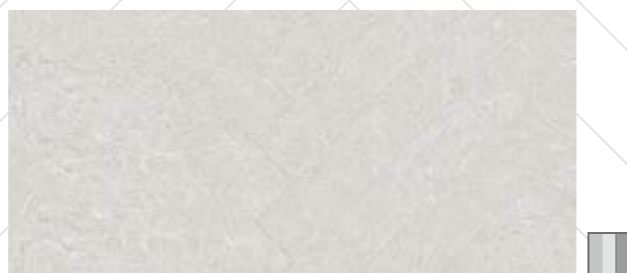

Marble Clear 1569 **New**  
LL 152 x 914

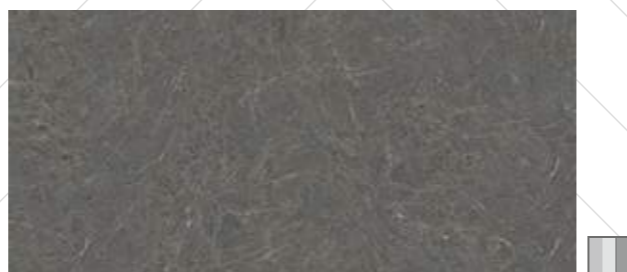

Marble Dark 1570 **New**  
LL 152 x 914

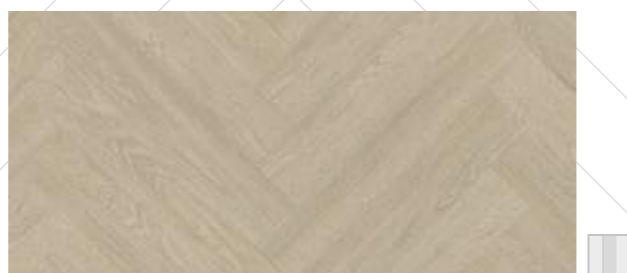

Tamo Light 1559 **New**  
LL 152 x 914

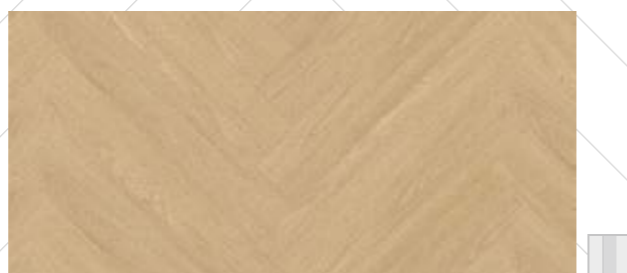

Tamo Clear 1567 **New**  
LL 152 x 914

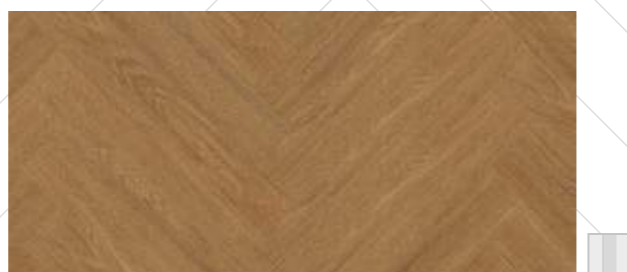

Tamo Light Brown 1568 **New**  
LL 152 x 914



Marble Clear / Tamo Clear

Creation  
Tiles & planks



# Creation Tiles & planks

## Creation 70

**DB**  
Creation 70  
(Dry Back)

**CLIC**  
Creation 70 Clic



Cervino Oak Cold Grey 1187  
**DB** 230 × 1500



Travertino Grey 1189  
**DB** 228 × 914



Onka Pearl 1056  
**DB** 230 × 1500 | **CLIC** 242 × 1461



Grace Bay Black 1050  
**DB** 208 × 1243 | **CLIC** 214 × 1239



Muse Smocked 1051  
**DB** 208 × 1243 | **CLIC** 214 × 1239



Toasted Wood Ash 1053  
**DB** 230 × 1500 | **CLIC** 242 × 1461



Muse Smocked / East Village



Toasted Wood Cafe



Wild Oak 0359  
**DB** 208 × 1243 | **CLIC** 214 × 1239



Toasted Wood Roadster 0800  
**DB** 230 × 1500 | **CLIC** 242 × 1461



Toasted Wood Cafe 0799  
**DB** 230 × 1500 | **CLIC** 242 × 1461



Onka Coffee 1057  
**DB** 230 × 1500 | **CLIC** 242 × 1461



# Creation Tiles & planks

## Creation 70

**DB**  
Creation 70  
(Dry Back)

**CLIC**  
Creation 70 Clic

**LL**  
Creation 70  
Looselay



Onka Natural 1055  
DB 230 × 1500 | CLIC 242 × 1461



Muse Sand 1052  
DB 208 × 1243 | CLIC 214 × 1239



Namou Light Honey 1578 **New**  
LL 235×1505



Onka Honey 1054  
DB 230 × 1500 | CLIC 242 × 1461 | LL 229 × 1220



Clifton Honey 1190  
DB 208 × 1243



Namou Honey 1579 **New**  
LL 235×1505



Serena 0545  
DB 208 × 1243 | CLIC 214 × 1239



Albion 0577  
DB 208 × 1243 | CLIC 214 × 1239



Namou Dark Honey 1580 **New**  
LL 235×1505



Diesel Nala 1075  
DB 230 × 1500

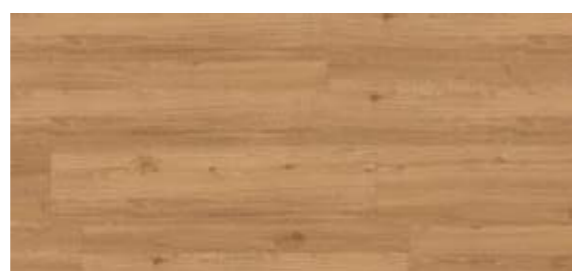

Clifton Chestnut 1191  
DB MIX : 152 × 914 / 76 × 914 / 228 × 914



Diesel Burnt 1074  
DB 230 × 1500

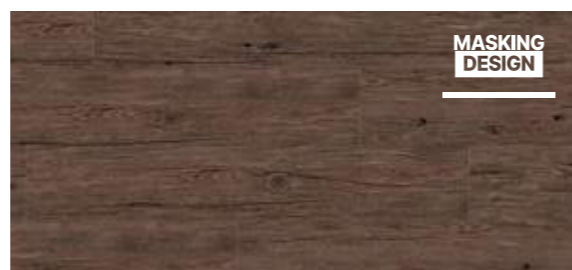

Deep Forest 0360  
DB 208 × 1243 | CLIC 214 × 1239



Diesel Nala

Creation  
Tiles & planks



# Creation Tiles & planks

## Creation 70

DB Creation 70 (Dry Back)    CLIC Creation 70 Clic    LL Creation 70 Looselay    CO Creation 70 Connect



Tamo Light 1559 **New**  
LL 229 × 1220 / 152 × 914



Tamo Dainty 1560 **New**  
LL 229 × 1220



Tamo Clear 1567 **New**  
LL 229 × 1220 / 152 × 914



Tamo Natural 1561 **New**  
LL 229 × 1220



Tamo Light Brown 1568 **New**  
LL 229 × 1220 / 152 × 914



Tamo Light / Marble Dark



Silversands 0324  
DB 208 × 1243



Midwest 0538  
DB 208 × 1243 | CLIC 214 × 1239



Oak Light 0090  
CO 701,3 × 701,3



Oak Golden 1492  
CO 701,3 × 701,3



Douglas 0535  
DB 208 × 1243



Limed Oak 0329  
DB 208 × 1243



Cervino Oak Beige 0797  
DB 230 × 1500 | CLIC 242 × 1461



Cervino Oak Nature 0798  
DB 230 × 1500 | CLIC 242 × 1461



Cervino Oak Honey Clear 1186  
DB 230 × 1500

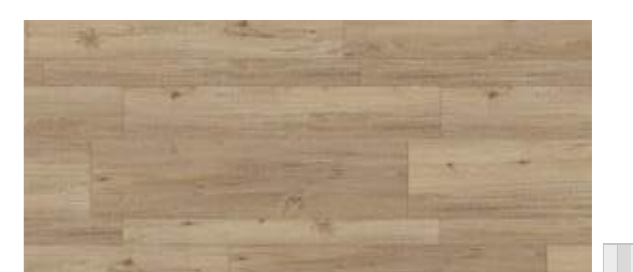

Clifton 0556  
DB MIX : 152 × 914 / 76 × 914 / 228 × 914



# Creation Tiles & planks

## Creation 70

**DB** Creation 70 (Dry Back)    **CLIC** Creation 70 Clic    **LL** Creation 70 Looselay    **CO** Creation 70 Connect



Clifton Grey 1192  
DB 208 x 1243



Travertino Beige 1188  
DB 228 x 914



Twist 0504 **New**  
LL 229 x 1220



Grace Bay Cream 1049  
DB 208 x 1243



Arena 0060 **New**  
LL 229 x 1220



Long Board 0455 **New**  
LL 229 x 1220



Solid Glam Picadilly 0803  
DB 184 x 1219



Denim Wood 0356  
DB 208 x 1243



Moon Island 0358  
DB 208 x 1243 | CLIC 214 x 1239



Regimental Picadilly 0807  
DB 184 x 1219



Portobello 0357  
DB 208 x 1243 | CLIC 214 x 1239



Osb Natural 0091  
CO 701,3 x 701,3



Solid Glam Picadilly / Regimental Picadilly



Ranch 0456 **New**  
LL 229 x 1220



Long Board

Creation Tiles & planks



# Creation Tiles & planks

## Creation 70

**DB** Creation 70 (Dry Back)    **CLIC** Creation 70 Clic    **LL** Creation 70 Looselay    **CO** Creation 70 Connect



Gentleman Tweed / Diesel Nala



Gentleman Taupe 1083  
**DB** 228 × 914 | **CO** 701,3 × 701,3



Tatami Smoked 1079  
**DB** 610 × 610



Prado Terracotta 1065  
**DB** 457 × 914 | **CLIC** 391 × 729



Gentleman Tweed 1076  
**DB** 228 × 914



Oxyd Pure 0088  
**DB** 457 × 914 | **CLIC** 391 × 729



Tatami Savane



Pure Concrete Beige 1063  
**DB** 914 × 914 | **CLIC** 391 × 729



Rough Textile Beige 0062  
**CO** 701,3 × 701,3

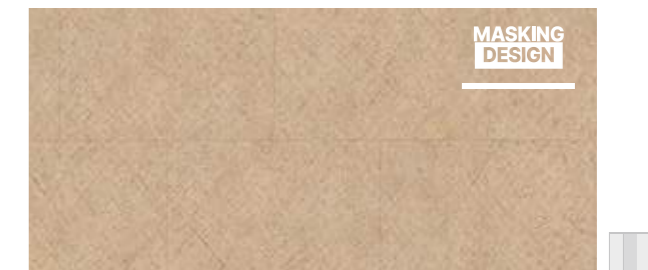

Tatami Savane 1077  
**DB** 610 × 610

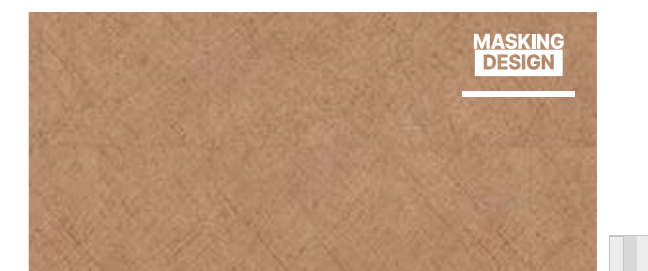

Tatami Raffia 1078  
**DB** 610 × 610



# Creation Tiles & planks

Creation 70

LL  
Creation 70  
Looselay



Chips Terra 1574 **New**  
LL 600 × 600

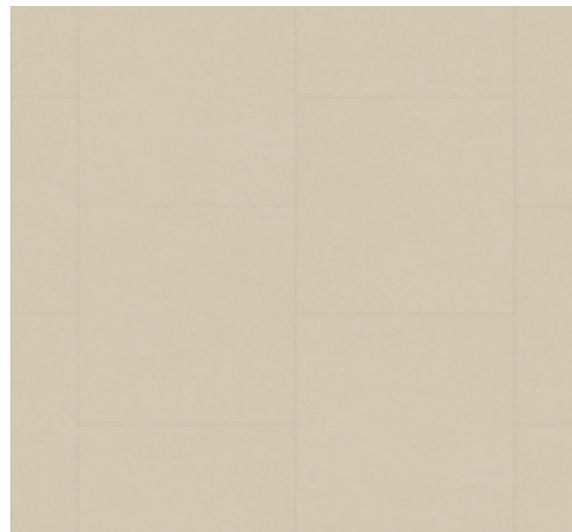

Urban Street Cream 1565 **New**  
LL 600 × 600



Urban Street Terra 1566 **New**  
LL 600 × 600



Chips Green 1573 **New**  
LL 600 × 600



Chips Blue 1572 **New**  
LL 600 × 600



Marble Green 1571 **New**  
LL 914 × 914



Marble Green / Chips Green



# Creation Tiles & planks

## Creation 70

**DB** Creation 70 (Dry Back)    **CLIC** Creation 70 Clic    **LL** Creation 70 Looselay    **CO** Creation 70 Connect

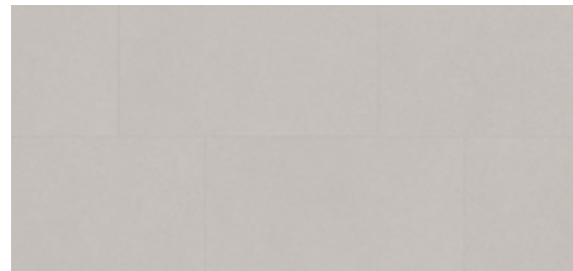

Pure Concrete Light 1060  
DB 914 × 914 | CLIC 391 × 729

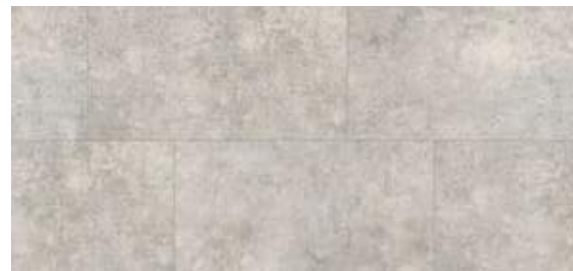

Secret Garden White 1059  
DB 457 × 914 | CLIC 391 × 729



Etna Beige 1068  
DB 457 × 914 / MIX : 152 × 914 / 305 × 914 / 457 × 914 (on demand)  
CLIC 391 × 729



Dock Taupe 0087  
DB 457 × 914 | CLIC 391 × 729 | CO 701,3 × 701,3 (0089)

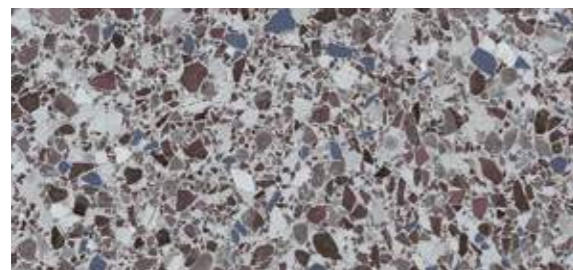

Dalma Burgundy 1089  
CO 701,3 × 701,3



Etna Beige



Marble Clear 1569 **New**  
LL 914 × 914 / 152 × 914

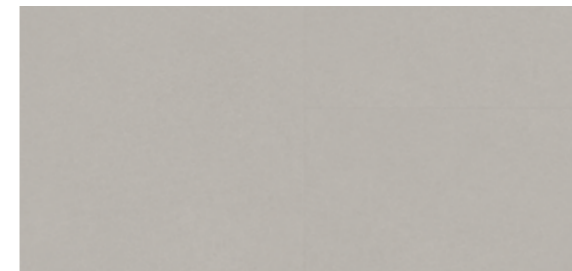

Urban Street Light 1283 **New**  
LL 914 × 914



Stony Medium 1576 **New**  
LL 600 × 600



Stony Cream 1575 **New**  
LL 600 × 600



Stony Cream / Urban Street Cream

Creation  
Tiles & planks



# Creation Tiles & planks

## Creation 70

DB Creation 70 (Dry Back)    CLIC Creation 70 Clic    LL Creation 70 Looselay    CO Creation 70 Connect



Urban Street Medium 1284 **New**  
LL 914 x 914



Marble Dark 1570 **New**  
LL 914 x 914 / 152 x 914



Urban Street Dark 1577 **New**  
LL 914 x 914



Pure Concrete Medium 1061  
DB 914 x 914 | CLIC 391 x 729



Rough Textile Grey 0063  
CO 701,3 x 701,3



Dock Grey 0085  
DB 457 x 914 | CLIC 391 x 729 | LL 914 x 914 | CO 701,3 x 701,3



Carassi 0561  
DB 228 x 914



Oxyd Iron 0089  
DB 457 x 914 | CLIC 391 x 729



Dalma Grey 1088  
CO 701,3 x 701,3

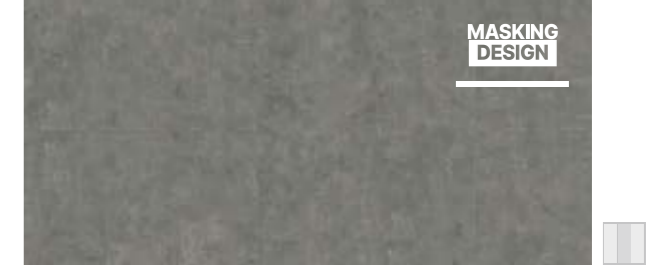

East Village 0522  
DB 610 x 610



Halifax 0531  
DB 610 x 610



Etna Dark 1069  
DB 457 x 914 | CLIC 391 x 729



Pure Concrete Dark 1062  
DB 914 x 914 | CLIC 391 x 729



# Creation Tiles & planks

## Creation 70

**DB**  
Creation 70  
(Dry Back)

**CLIC**  
Creation 70 Clic

**CO**  
Creation 70  
Connect



Terrazzo Nature

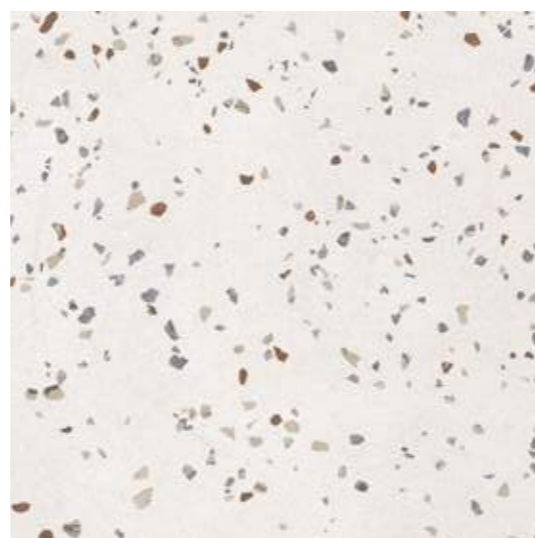

Terrazzo Nature\* 1067  
DB 914 x 914



Terrazzo Ocre\* 1066  
DB 914 x 914



Gentleman Grey /  
Gentleman Garance /  
Gentleman Peppermint



Gentleman Garance 1080  
DB 610 x 610



Gentleman Indigo 1081  
DB 610 x 610



Gentleman Peppermint 1082  
DB 610 x 610



Gentleman Grey 1058  
DB 610 x 610 | CLIC 391 x 729 | CO 701,3 x 701,3 (0088)



Prado Green 1064  
DB 457 x 914 | CLIC 391 x 729



# Creation Tiles & planks

## Creation 70

Code	Color Design	Dry Back	Clic	Looselay	Connect	Skirting Matching Design	Emboss	NCS	LRV
0085	Dock Grey	457x914	391x729	914x914	7013x7013	S111	Hammered	6500-N	201
0087	Dock Taupe	457x914	391x729	-	7013x7013	S020	Hammered	6005-Y50R	19,2
1058	Gentleman Grey	610x610	391x729	-	7013x7013 (0088)	Blanc	Textile	7500-N	12,7
0538	Midwest	208x1243	214x1239	-	-	S039	Natural	3010-Y30R	38,9
0358	Moon Island	208x1243	214x1239	-	-	S034	Brushed	4010-Y30R	24,8
1054	Onka Honey	230x1500	242x1461	-	-	S121	Natural	4020-Y40R	26,6
0357	Portobello	208x1243	214x1239	-	-	S053	Brushed	5005-Y50R	23,5
1062	Pure Concrete Dark	914x914	391x729	-	-	Blanc	Hammered	7500-N	11,1
1060	Pure Concrete Light	914x914	391x729	-	-	Blanc	Hammered	3500-N	39,1
1061	Pure Concrete Medium	914x914	391x729	-	-	Blanc	Hammered	4502-B	28,4
0577	Albion	208x1243	214x1239	-	-	S108	Natural	4020-Y30R	21,8
0797	Cervino Oak Beige	230x1500	242x1461	-	-	S011	Natural	3010-Y30R	40,1
0798	Cervino Oak Nature	230x1500	242x1461	-	-	S109	Natural	5020-Y20R	28,3
0360	Deep Forest	208x1243	214x1239	-	-	S110	Brushed	6010-Y50R	15,8
1068	Etna Beige	MIX 152x914 / 305x914 / 457x914 on demand	391x729	-	-	Blanc	Hammered	4005-Y80R	36,6
1069	Etna Dark	457x914	391x729	-	-	Blanc	Hammered	6502-R	12,9
1050	Grace Bay Black	208x1243	214x1239	-	-	Blanc	Natural	2500-N	32,0
1049	Grace Bay Cream	208x1243	214x1239	-	-	Blanc	Natural	2005-Y80R	49,1
1052	Muse Sand	208x1243	214x1239	-	-	S117	Natural	3010-Y40R	39,4
1051	Muse Smoked	208x1243	214x1239	-	-	S118	Natural	5005-Y80R	21,3
1057	Onka Coffee	230x1500	242x1461	-	-	Blanc	Natural	8005-Y80R	7,0
1055	Onka Natural	230x1500	242x1461	-	-	S122	Natural	3020-Y60R	31,1
1056	Onka Pearl	230x1500	242x1461	-	-	S120	Natural	4005-R20B	32,9
0089	Oxyd Iron	457x914	391x729	-	-	Blanc	Perforated	8000-N	9,4
0088	Oxyd Pure	457x914	391x729	-	-	Blanc	Perforated	6020-Y30R	17,2
1063	Pure Concrete Beige	914x914	391x729	-	-	Blanc	Hammered	4005-Y50R	34,3
1064	Prado Green	457x914	391x729	-	-	Blanc	Stone	7502-G	12,1
1065	Prado Terracotta	457x914	391x729	-	-	Blanc	Stone	4010-Y90R	23,1
1059	Secret Garden White	457x914	391x729	-	-	Blanc	Stone	2502-Y	50,2
0545	Serena	208x1243	214x1239	-	-	S132	Natural	6010-Y30R	16,7
1067	Terrazzo Nature	914x914	-	-	-	Blanc	Stone	2000-N	64,4
1066	Terrazzo Ocre	914x914	-	-	-	Blanc	Stone	2002-Y50R	54,5
1053	Toasted Wood Ash	230x1500	242x1461	-	-	Blanc	Natural	7502-R	10,6
0799	Toasted Wood Cafe	230x1500	242x1461	-	-	Blanc	Natural	8010-Y30R	8,4
0800	Toasted Wood Roadster	230x1500	242x1461	-	-	Blanc	Natural	7010-Y30R	13,6
0359	Wild Oak	208x1243	214x1239	-	-	S075	Brushed	4020-Y30R	26,8
0356	Denim Wood	208x1243	-	-	-	S026	Natural	2502-Y	41,4
1074	Diesel Burnt	230x1500	-	-	-	Blanc	Natural	8010-Y30R	8,1
1075	Diesel Nala	230x1500	-	-	-	Blanc	Natural	5020-Y30R	16,7
1080	Gentleman Garance	610x610	-	-	-	Blanc	Textile	5030-Y90R	13,7
1081	Gentleman Indigo	610x610	-	-	-	Blanc	Textile	5030-R90B	16,3
1082	Gentleman Peppermint	610x610	-	-	-	Blanc	Textile	6020-G	16,3
1083	Gentleman Taupe	228x914	-	-	7013x7013 (0089)	Blanc	Textile	5502-Y	21,2
1076	Gentleman Tweed	228x914	-	-	-	Blanc	Textile	6010-Y50R	16,2
1077	Tatami Savane	610x610	-	-	-	Blanc	Stone	3010-Y20R	31,6
1079	Tatami Smoked	610x610	-	-	-	Blanc	Stone	7005-Y20R	12,2
1078	Tatami Raffia	610x610	-	-	-	Blanc	Stone	4020-Y30R	24,4
0561	Carassi	228x914	-	-	-	Blanc	Rib Wood	5502-G	21,7
1187	Cervino Oak Cold Grey	230x1500	-	-	-	Blanc	Natural	3502-R	33,8
1186	Cervino Oak Honey Clear	230x1500	-	-	-	Blanc	Natural	4020-Y30R	27,6
0556	Clifton	Mix 152x914 / 76x914 / 228x914	-	-	-	S144	Natural	5010-Y10R	23,2
1191	Clifton Chesnut	Mix 152x914 / 76x914 / 228x914	-	-	-	Blanc	Natural	4020-Y40R	25,2
1192	Clifton Grey	208x1243	-	-	-	Blanc	Natural	3005-R20B	45,7
1190	Clifton Honey	208x1243	-	-	-	Blanc	Natural	4020-Y40R	24,2
0535	Douglas	208x1243	-	-	-	Blanc	Natural	4005-Y50R	29,1
0522	East Village	610x610	-	-	-	S154	Stone	4502-G	22,0
0531	Halifax	610x610	-	-	-	S032	Stone	6502-Y	16,7
0329	Limed Oak	208x1243	-	-	-	S147	Natural	2010-Y20R	42,0
0807	Regimental Picadilly	184x1219	-	-	-	Blanc	Natural	4005-Y20R	20,6
0324	Silversands	208x1243	-	-	-	S146	Natural	3010-Y20R	33,1
0803	Solid Glam Picadilly	184x1219	-	-	-	Blanc	Natural	5005-Y20R	27,8
1188	Travertino Beige	228x914	-	-	-	Blanc	Stone	3005-Y80R	46,9
1189	Travertino Grey	228x914	-	-	-	Blanc	Stone	3502-B	36,7
1089	Dalma Burgundy	-	-	-	7013x7013	Blanc	Hammered	6005-Y80R	24,7
1088	Dalma Grey	-	-	-	7013x7013	Blanc	Hammered	7005-R80B	19
1492	Oak Golden	-	-	-	7013x7013	Blanc	Natural	4020-Y30R	27,9
0090	Oak Light	-	-	-	7013x7013	Blanc	Natural	5500-N	21,1
0091	Osb Natural	-	-	-	7013x7013	Blanc	Hammered	5500-N	21,1
0062	Rough Textile Beige	-	-	-	7013x7013	Blanc	Textile	5005-Y20R	25,4
0063	Rough Textile Grey	-	-	-	7013x7013	Blanc	Textile	5500-N	21,1
0060	Arena	-	229x1220	-	-	S026	Natural	4005-Y20R	37,2
1572	Chips Blue	-	600x600	-	-	-	Hammered	1502-B	62,5
1573	Chips Green	-	600x600	-	-	-	Hammered	1502-G	53,2
1574	Chips Terra	-	600x600	-	-	-	Hammered	1502-Y	64,6
0455	Long Board	-	229x1220	-	-	S034	Brushed	4010-Y30R	24,8
1569	Marble Clear	-	914x914	-	-	-	Hammered	2000-N	53,8
1570	Marble Dark	-	914x914	-	-	-	Hammered	7502-R	13,9
1571	Marble Green	-	914x914	-	-	-	Hammered	5010-G10Y	24,6
1580	Namou Dark Honey	-	235x1505	-	-	S008	Natural	4030-Y20R	23,5
1579	Namou Honey	-	235x1505	-	-	S058	Natural	4020-Y20R	33,6
1578	Namou Light Honey	-	235x1505	-	-	S019	Natural	3020-Y20R	34,5
0456	Ranch	-	229x1220	-	-	S053	Brushed	5005-Y50R	23,5
1575	Stony Cream	-	600x600	-	-	S001	Hammered	3502-Y	35,8
1576	Stony Medium	-	600x600	-	-	S001	Hammered	3502-B	38,1
1567	Tamo Clear	-	229x1220	-	-	S168	Natural	3020-Y20R	33,3
1560	Tamo Dainty	-	152x914	-	-	S001	Natural	4020-Y30R	24
1559	Tamo Light	-	152x914	-	-	S188	Natural	3010-Y20R	36,6
1568	Tamo Light Brown	-	229x1220	-	-	S202	Natural	5020-Y30R	17,2
1561	Tamo Natural	-	229x1220	-	-	S016	Natural	4020-Y20R	24,4
0504	Twist	-	229x1220	-	-	S039	Natural	3010-Y30R	38,9
1565	Urban Street Cream	-	600x600	-	-	S178	Hammered	2005-Y20R	50
1577	Urban Street Dark	-	914x914	-	-	S001	Hammered	7500-N	11,1
1283	Urban Street Light	-	914x914	-	-	S094	Hammered	3000-N	42,3
1284	Urban Street Medium	-	914x914	-	-	S180	Hammered	4502-R	26,5
1566	Urban Street Terra	-	600x600	-	-	S001	Hammered	5020-Y50R	21,6

S001 : White

## Packaging

Product size (mm)	m <sup>2</sup> /box	m <sup>2</sup> /palette
<b>Creation 70 (Dry Back)</b>		
184 x 1219	3,36	215,32
184 x 1219*	3,14	213,53
208 x 1243	3,62	195,46
228 x 914	3,54	212,65
230 x 1500	3,11	204,93
457 x 914	3,76	203,09
610 x 610	3,35	187,54
914 x 914	4,18	204,84
MIX Planks	3,34	213,49
MIX Tiles	3,34	200,58

\* Regimental Picadilly 0807

Product size (mm)	m <sup>2</sup> /box	m <sup>2</sup> /palette
<b>Creation 70 Clic</b>		
214 x 1239	1,59	85,86
242 x 1461	1,77	84,96
391 x 729	1,43	85,80
<b>Creation 70 Looselay</b>		
229 x 1220	1,67	100,2
152 x 914	1,67	100,2
235 x 1505	1,41	95,9
600 x 600	1,44	83,5
914 x 914	3,34	100,2
<b>Creation 70 Connect</b>		
701,3 x 701,3	-	49,14

## Exclusive embosses



Stone



Brushed



Saw effect



Natural



Hammered



Perforated

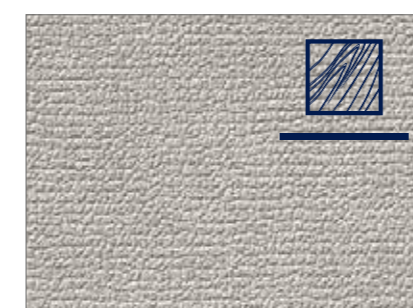

Textile



Rib Wood





# Creation Tiles & planks

## Creation Saga<sup>2</sup> **New**

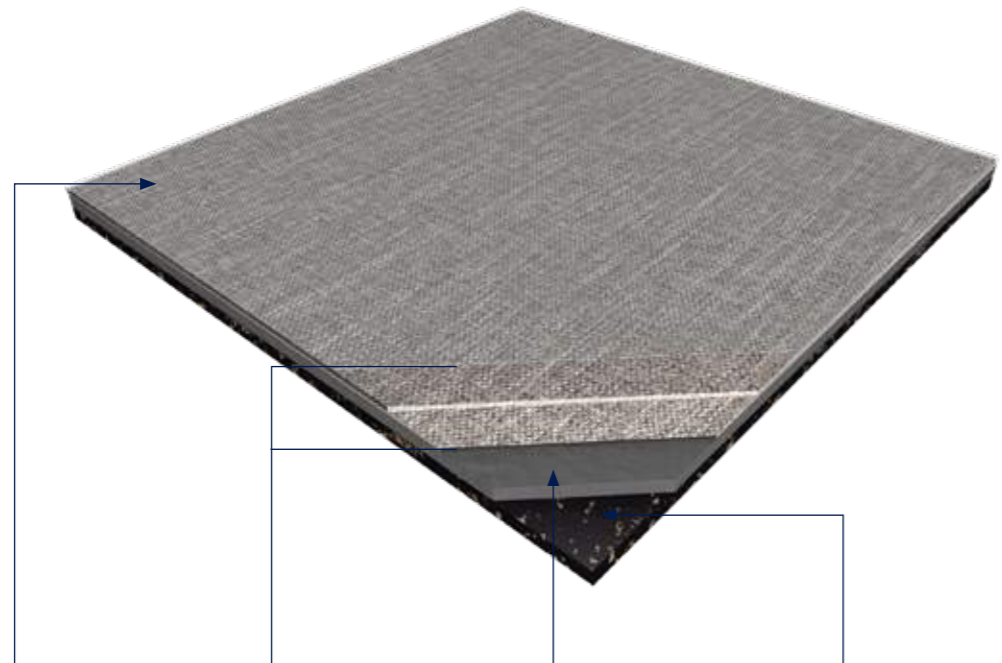
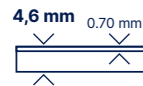

### PROTECSOL®



Easy maintenance

### 4D DESIGN

#### MATT SURFACE



Natural look

#### CRISTAL WEAR LAYER



High definition design & color

#### STRUCTURED EMBOSS



Ultra realistic surface

#### DESIGNS

Exclusive designs

### RESILIENT CORE



Noise absorption



Acoustic



Soft underfoot



Renovation ceramic 5 mm joint

### CORK BACKING



15 dB Impact Sound Insulation



Environmental friendly



Easily removable

Formats (mm)



Looselay Removable

## Creation Saga<sup>2</sup>

**Creation Saga<sup>2</sup>** is a synthetic, decorative, flexible, antistatic, abrasion group T floorcovering available in tiles. It consists in a 0.70 mm thick transparent wear layer, a design film, a calendered layer and a PVC/Cork sublayer which provides acoustic properties with 15 dB impact sound insulation and a walking noise < 65 dB. The overall thickness is 4.6 mm. It benefits from a **ProtecSol®** surface treatment, making maintenance easier and eliminating the need for initial polishes.

**Creation Saga<sup>2</sup>** is a loose lay floorcovering, resistant to use (commercial / industrial use) of 34-43 according to EN-ISO 10874 and has Bfl-s1 class for smoke emission according to EN 13501-1.

**Creation Saga<sup>2</sup>** is made with phthalate free plasticizers, except recycled content. It is 100% recyclable and made with 55% of recycled content. It is REACH compliant. **The product emission rate of organic compounds is < 10 microgram/m<sup>3</sup>** (TVOC < 28 days – ISO 16000-6).



Comfort & Resistance



Acoustic



Renovation ceramic 5 mm joint



90° installation



### Creation Saga<sup>2</sup>

#### Description

Total thickness	EN ISO 24346	mm	4.6
Thickness of wearlayer	EN ISO 24340	mm	0.70
Weight	EN ISO 23997	g/sqm	5595
Tile size	EN ISO 24342	mm	500 x 500
Number of tiles and sqm per box	-	-	10 / 2.50

#### Classification

Norm / Product specification	-	-	EN 652
European classification	EN ISO 10874	class	34-42
Fire rating	EN 13501-1	class	Bfl-s1
Static electrical propensity	EN 1815	kV	< 2
Slip resistance wet <sup>(1)</sup>	EN 16165:2021 – Appendix B (DIN 51 130)	class	R10

#### Performances

Wear resistance	EN 660.2	mm <sup>3</sup>	≤ 2.0
Wear group	-	group	T
Dimensional stability (norm)	EN ISO 23999	%	≤ 0.15
Dimensional stability (average measured value)	-	%	≈ 0.05
Residual indentation	EN ISO 24343-1	mm	< 0.13
Castor chair test (type H)	ISO 4918	-	OK
Impact sound insulation	EN ISO 717-2	dB	15
Room impact	NF-S 31074	dB	< 65
Thermal conductivity	EN ISO 10456	W/(m.k)	0.25
Colour fastness	EN ISO 105-B02	degree	≥ 6
Surface treatment	-	-	ProtecShield™
Chemical products resistance	EN ISO 26987	-	OK

#### Environment / indoor air quality

TVOC after 28 days	ISO 16000-6	microgram/m <sup>3</sup>	< 10
--------------------	-------------	--------------------------	------

#### CE marking



EN 14041



(1) Ramp test with oil



# Creation Tiles & planks

Creation Saga<sup>2</sup> **New**

Creation Saga<sup>2</sup>  
500 × 500 mm



Oxyd Light Grey / Urban Street Medium

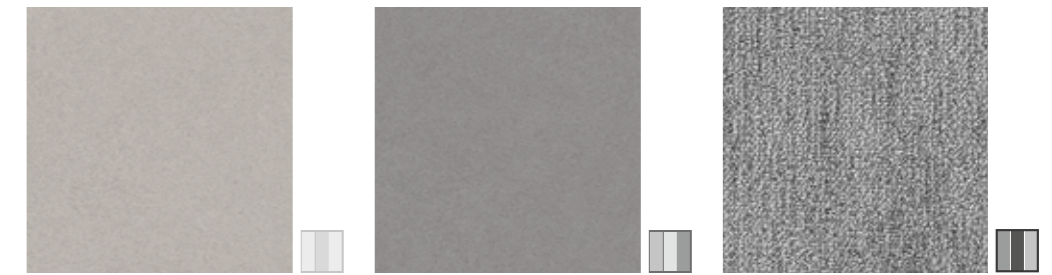

Urban Street Light 1283

Urban Street Medium 1284

Oxyd Light Grey 1610



Gentleman Taupe 0089

Tweed Green Chine 1585

Gentleman Jean Chine 1582



Oxyd Light Beige 1608

Tweed Chine Amande 1584

Tweed Light Grey 1586



Gentleman Grey 0088

Oxyd Light Green 1609

Gentleman Blue 0030

Scale : 1/5<sup>th</sup>

Design shade variation:  Light  Medium  high



# Creation Tiles & planks

Creation Saga<sup>2</sup> **New**

Creation Saga<sup>2</sup>  
500 × 500 mm



Gentleman Abricot

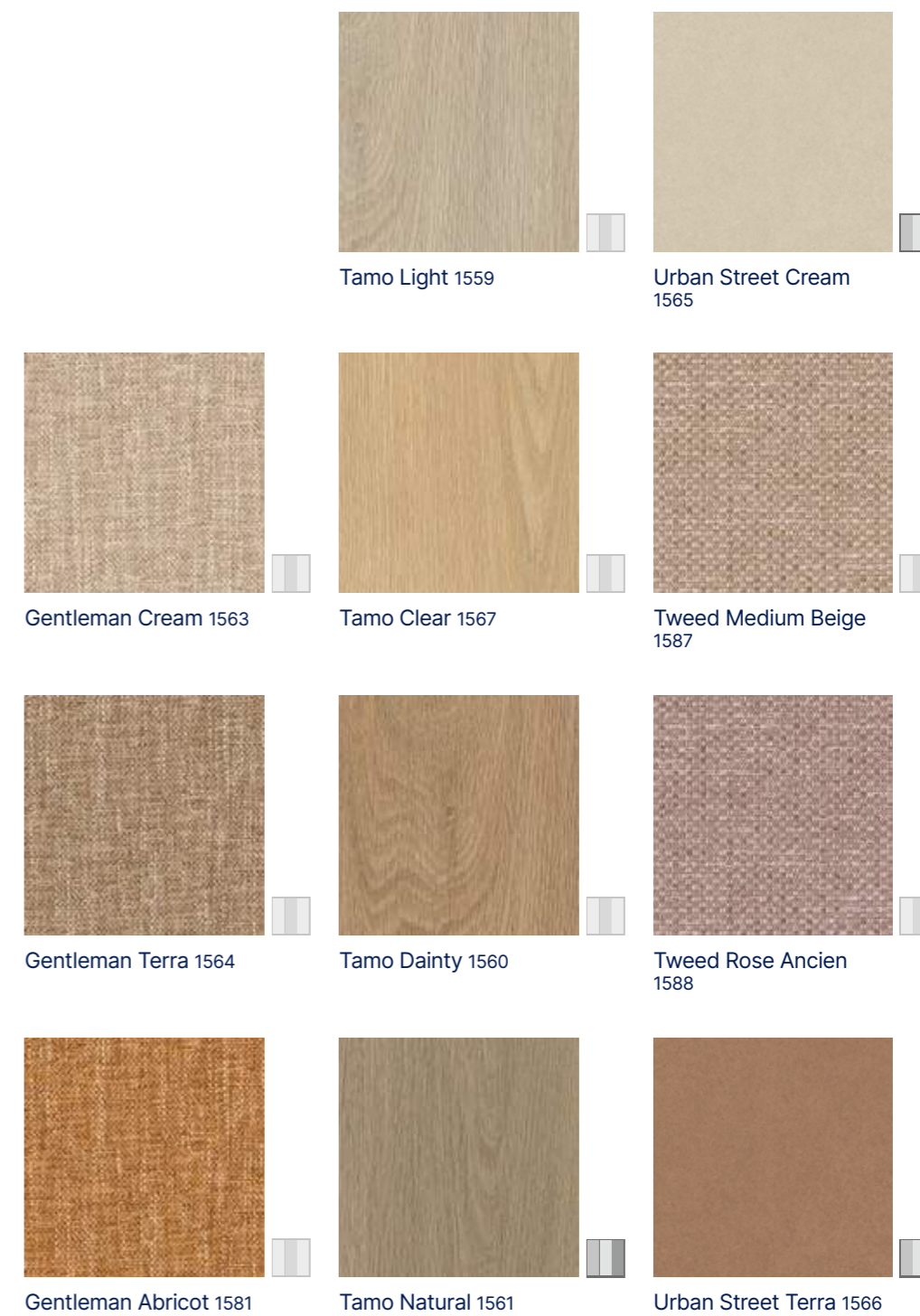

Scale : 1/5<sup>th</sup>

Design shade variation: Light Medium high



# Creation Tiles & planks

## Creation 55

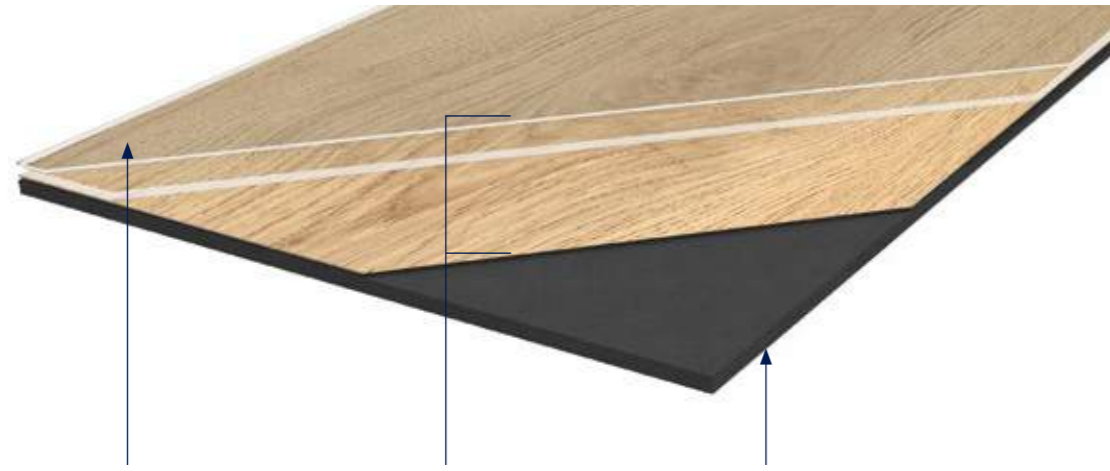
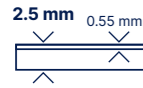

### PROTECSHIELD™

#### ENHANCED PERFORMANCES



Micro scratch resistance



Easy maintenance

#### ULTRA MATT SURFACE



Natural look

### 4D DESIGN

#### CRYSTAL WEAR LAYER



Authentic Look

#### HIGH DEFINITION PRINTED FILM



Ultra realism

#### STRUCTURED EMBOSS



Ultra realistic surface

#### BEVELLED EDGES



Tiles & Planks effect

### RESILIENT COMFORT CORE



Acoustic comfort



Walking comfort



Easy installation



Easy cutting

## Creation Tiles & planks decorative strips

Format (mm) 4×914mm



Code: 3203 + Color code



100% Reach Phthalate free



100% Recyclable Up to 35% recycled content



TVOC emissions below detection level (TVOC < 10µg/m³ after 28 days) No formaldehyde

Formats (mm)



Glue down

## Creation 55

**Creation 55** is a synthetic, decorative, flexible, antistatic abrasion group T floorcoverings available in tile or plank, with bevelled edges. It consists in a 0.55 mm thick transparent wear layer, a design film and a Resilient Comfort Core to provide softness and comfort surface. The overall thickness is 2.5 mm. They benefit from a cross-linked polyurethane surface treatment (**Protecshield™**), making maintenance easier and prevent from micro scratches.

**Creation 55** is a glued floorcovering, resistant to use (commercial / industrial use) of 33 / 42 according to EN-ISO 10874 and has Bfl -s1 class for smoke emission according to EN 13501-1.

**Creation 55** is made with phthalate free plasticizers, except recycled content. It is 100% recyclable and made with 35% of recycled content. It is 100% compliant with REACH. **The product emission rate of organic compounds is < 10 microgram/m³** (TVOC < 28 days - ISO 16000-6).

Can be combined with pre-adhesive underlayer

Gerflor Smart Fix 16dB



Code: 1698 - Format: 1m x 7.5ml



### Creation 55

Creation 55	Creation 55 Trend	Creation 55 Design
-------------	-------------------	--------------------

Description			
Total thickness	EN ISO 24346	mm	2.50
Thickness of wearlayer	EN ISO 24340	mm	0.55
Weight	EN ISO 23997	g/sqm	3850
Size	EN ISO 24342	mm	Planks - 184,15×1219,2 / 914,4×914,4 / 152×762 / 230×1500 Tiles - 457,2×914,4 / 609,6×609,6
Number of planks / tiles and sqm per box	-	-	15-5-33-9-9-9/ 3,36-4,18-3,82-3,11-3,76-3,35
<b>Classification</b>			
Norm / Product specification	-	-	EN ISO 10582
European classification	EN ISO 10874	class	33-42
Fire rating	EN 13501-1	class	Bfl-s1
Static electrical propensity	EN 1815	kV	< 2
Slip resistance wet: ramp test with oil	EN 16165:2021 - Appendix B (DIN 51 130)	class	R10
<b>Performances</b>			
Wear resistance	EN 660.2	mm³	≤ 2.0
Wear group	-	group	T
Type Binder content	ISO 10582	type	I
Room impact	NF S 31074	dB	77
Impact sound insulation	EN ISO 717-2	dB	4
Dimensional stability (norm)	EN ISO 23999	%	≤ 0.25
Dimensional stability (average measured value)	-	%	≤ 0.10
Residual indentation	EN ISO 24343-1	mm	≤ 0.10
Castor chair test (type H)	ISO 4918	-	OK
Thermal conductivity	EN ISO 10456	W/(m.k)	0.25
Colour fastness	EN ISO 105-B02	degree	≥ 6
Surface treatment	-	-	ProtecShield™
Chemical products resistance	EN ISO 26987	-	OK
<b>Environment / indoor air quality</b>			
TVOC after 28 days	ISO 16000-6	microgram/m³	< 10
Certification	-	-	Floorscore®

### CE marking



EN 14041





# Creation Tiles & planks

## Creation 55 Solid Clic

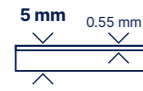

### PROTECSHIELD™

#### ENHANCED PERFORMANCES

Micro scratch resistance

Easy maintenance

#### ULTRA MATT SURFACE

Natural look

### 4D DESIGN

#### CRYSTAL WEAR LAYER

Authentic Look

#### HIGH DEFINITION PRINTED FILM

Ultra realism

#### STRUCTURED EMBOSS

Ultra realistic surface

#### BEVELLED EDGES

Tiles & Planks effect

### DUOCORE 2.0 TECHNOLOGY

#### RESILIENT COMFORT CORE

Acoustic comfort



Walking comfort

#### NEW RIGID CORE



Renovation over ceramic tiles 6mm/2mm



Resistance against high temperature variation

### EXCLUSIVE INTERLOCKING SYSTEM

#### ANGULAR ON LONG SIDE

Quiet installation

#### VERTICAL ON SHORT SIDE

Traffic resistance Durability



Fast & easy to install



Waterproof Joints



100% Reach Phthalate free



100% Recyclable Up to 55% recycled content



TVOC emissions below detection level (TVOC < 10µg/m³ after 28 days) No formaldehyde

Formats (mm) 212x1239 240x1461 389x729 | Protecshield™



## Creation 55 Solid Clic

**Creation 55 Solid Clic** is a decorative, flexible, abrasion group T floorcoverings available in tiles and planks, with bevelled edges. It consists in a 0,55 mm thick transparent wear layer, a design film of 2 m width printed in high definition to have more variety in the design and the technology "Duo Core 2.0": combination of a rigid core back layer for easy renovation and a flexible core top layer to provide softness and comfort surface, the whole with a double reinforcement for enhanced durability. The overall thickness is 5 mm. They benefit from a cross-linked polyurethane surface treatment (**Protecshield™**), making maintenance easier and avoiding microscratches.

**Creation 55 Solid Clic** is an interlocking floorcovering assembled with a vertical system on the short side and a horizontal system on long side for a quick and solid installation. It has a European class (commercial / industrial use) 33/42 according to EN-ISO 10874 and has Bfl-s1 class for smoke emission according to EN 13501-1. **Creation 55 Solid Clic** is made with phthalate free plasticizers (except recycled content). It is 100% recyclable and made with a recycled content up to 55%. It is 100% compliant with REACH. **The product emission rate of organic compounds is < 10 microgram/m³ (TVOC < 28 days - ISO 16000-6).**

## To be combined with Gerflor acoustic underlayers

Gerflor Acoustic 15 dB



Code: 1798 - Format: 1m x 15ml

Gerflor Acoustic Plus 19 dB



Code: 0704 - Format: 0.98m x 15.3ml

Gerflor Silence Plus 19 dB



Code: 5949 - Format: 1.18m x 8.5ml

### Creation 55 Solid Clic

#### Description

Total thickness	EN ISO 24346	mm	5.00
Thickness of wearlayer	EN ISO 24340	mm	0.55
Weight	EN ISO 23997	g/sqm	7781
Size	EN ISO 24342	mm	Planks - 212x1238,8 / 239,6x1460,8 Tiles - 388,8x728,7
Number of planks / tiles and sqm per box	EN ISO 24342	mm	7-6-6 / 1,84-2,10-1,70

#### Classification

Norm / Product specification	-	-	EN ISO 10582
European classification	EN ISO 10874	class	33-42
Fire rating	EN 13501-1	class	Bfl-s1
Static electrical propensity	EN 1815	kV	< 2
Slip resistance wet: ramp test with oil	EN 16165:2021 - Appendix B (DIN 51 130)	class	R10

#### Performances

Wear resistance	EN 660.2	mm³	< 2.0
Wear group	-	group	T
Type Binder content	ISO 10582	type	I
Room impact	NF S 31074	dB	79
Impact sound insulation	EN ISO 717-2	dB	4
Dimensional stability (norm)	EN ISO 23999	%	≤ 0.15
Dimensional stability (average measured value)	-	%	≈ 0.05
Residual indentation	EN ISO 24343-1	mm	≤ 0.10
Castor chair test (type H)	ISO 4918	-	OK
Thermal conductivity	EN ISO 10456	W/(m.k)	0.25
Colour fastness	EN ISO 105-B02	degree	≥ 6
Surface treatment	-	-	ProtecShield™
Chemical products resistance	EN 423	-	OK

#### Environment / indoor air quality

TVOC after 28 days	ISO 16000-6	microgram/m³	< 10
Certification	-	-	Floorscore®

#### CE marking



EN 14041





# Creation Tiles & planks

## Creation 55 Rigid Acoustic

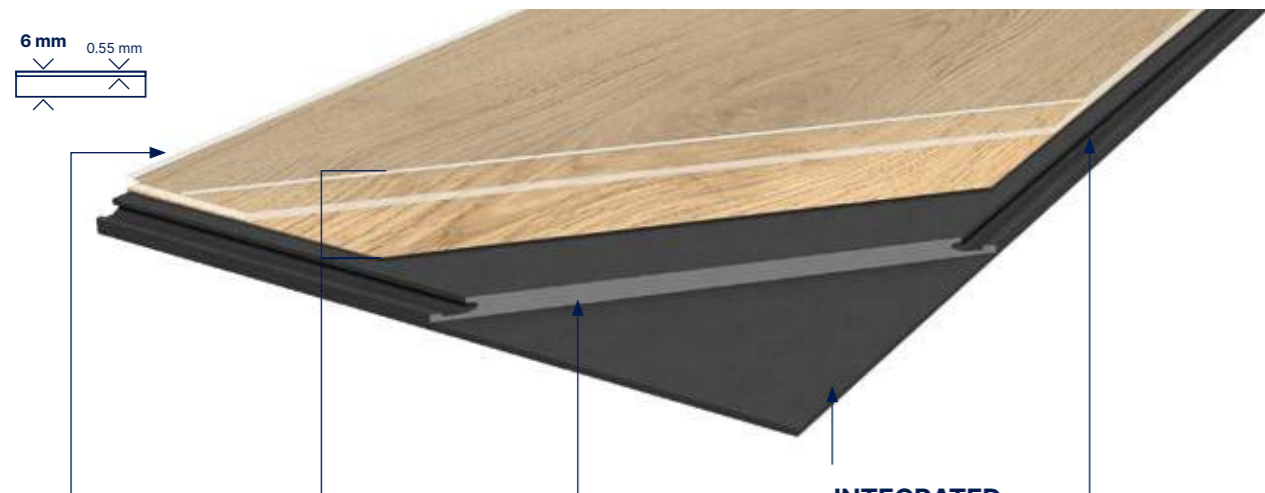

6 mm  
0.55 mm

### PROTECSHIELD™

#### ENHANCED PERFORMANCES



Micro scratch resistance



Easy maintenance

#### ULTRA MATT SURFACE

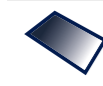

Natural look

### 4D DESIGN

#### CRYSTAL WEAR LAYER



Authentic Look

#### HIGH DEFINITION PRINTED FILM



Ultra realism

#### STRUCTURED EMOSS



Ultra realistic surface

#### BEVELLED EDGES



Tiles & Planks effect

### RIGID CORE TECHNOLOGY



Renovation over ceramic tiles 8mm/3mm



Resistance against high temperature variation

### INTEGRATED ACOUSTIC UNDERLAY

#### ACOUSTIC UNDERLAYER



Sound insulation 19dB



Absorbs default of the subfloor (up to 1mm unevenness)

### INTERLOCKING SYSTEM

#### ANGLE TO ANGLE LOCKING SYSTEM



Standard laminate installation

Formats (mm)

177x1219

225x1524

125x750

457x914

Protecshield™



## Creation 55 Rigid Acoustic

**Creation 55 Rigid Acoustic** is a decorative flooring, rigid interlocking with acoustic layer, antistatic, abrasion group T floorcoverings available in tiles and planks, with bevelled edges.

It is made with :

- a 0,55 mm thick transparent wear layer to provide durability
- a high definition printing film to provide an hyper realistic design aspect
- a Full Rigid Board to provide high performances for heavy renovations
- an integrated underlayer 100% recyclable which provides a 19 dB sound reduction market.

The total thickness of the product is 6 mm. The produce is also using a cross-linked polyurethane surface treatment

(Protecshield™), making maintenance easier, durability longer, protecting from micro scratches, and providing an ultra-mat effect for more realistic look.

**Creation 55 Rigid Acoustic** is an interlocking floorcovering assembled with an angle/angle locking system to provide robust and easy installation. It has an European class (commercial/industrial) of 33/42 according to EN-ISO 10874 and has Bfl-s1 class for smoke emission according to EN 13501-1.

**Creation 55 Rigid Acoustic** is made with phthalate free plasticizers. It is 100% recyclable and made with up to 35% of recycled content. It is 100% compliant with REACH.

**The product emission rate of organic compounds is < 10 microgram/m<sup>3</sup> (TVOC < 28 days – ISO 16000-6).**



Ballerina

### Creation 55 Rigid Acoustic

#### Description

Total thickness	EN ISO 24346	mm	6.00
Thickness of wearlayer	EN ISO 24340	mm	0.55
Weight	EN ISO 23997	g/sqm	9480
Size	EN ISO 24342	mm	Planks - 125x750 / 177x1219 / 225x1524 Tiles - 457x914
Number of planks / tiles and sqm per box	EN ISO 24342	mm	16-8-5-4 / 1,50-1,73-1,71-1,67

#### Classification

Norm / Product specification	-	-	EN ISO 10582
European classification	EN ISO 10874	class	33-42
Fire rating	EN 13501-1	class	Bfl-s1
Static electrical propensity	EN 1815	kV	< 2
Slip resistance wet: ramp test with oil	EN 16165:2021 – Appendix B (DIN 51 130)	class	R10

#### Performances

Wear resistance	EN 660.2	mm <sup>3</sup>	< 2.0
Wear group	-	group	T
Type Binder content	ISO 10582	type	I
Room impact	NF S 31074	dB	81
Impact sound insulation	EN ISO 717-2	dB	19
Dimensional stability (norm)	EN ISO 23999	%	≤ 0.15
Dimensional stability (average measured value)	-	%	≤ 0.05
Residual indentation	EN ISO 24343-1	mm	≤ 0.10
Castor chair test (type H)	ISO 4918	-	OK
Thermal conductivity	EN ISO 10456	W/(m.k)	0.25
Colour fastness	EN ISO 105-B02	degree	≥ 6
Surface treatment	-	-	ProtecShield™
Chemical products resistance	EN 423	-	OK

#### Environment / indoor air quality

TVOC after 28 days	ISO 16000-6	microgram/m <sup>3</sup>	< 10
Certification	-	-	Floorscore®

#### CE marking



EN 14041



100% REACH  
Phthalate free



100% RECYCLABLE  
Up to 35% recycled content



TVOC emissions below  
detection level  
(TVOC < 10µg/m<sup>3</sup> after 28 days)  
No formaldehyde



# Creation Tiles & planks

## Creation 55 Looselay New

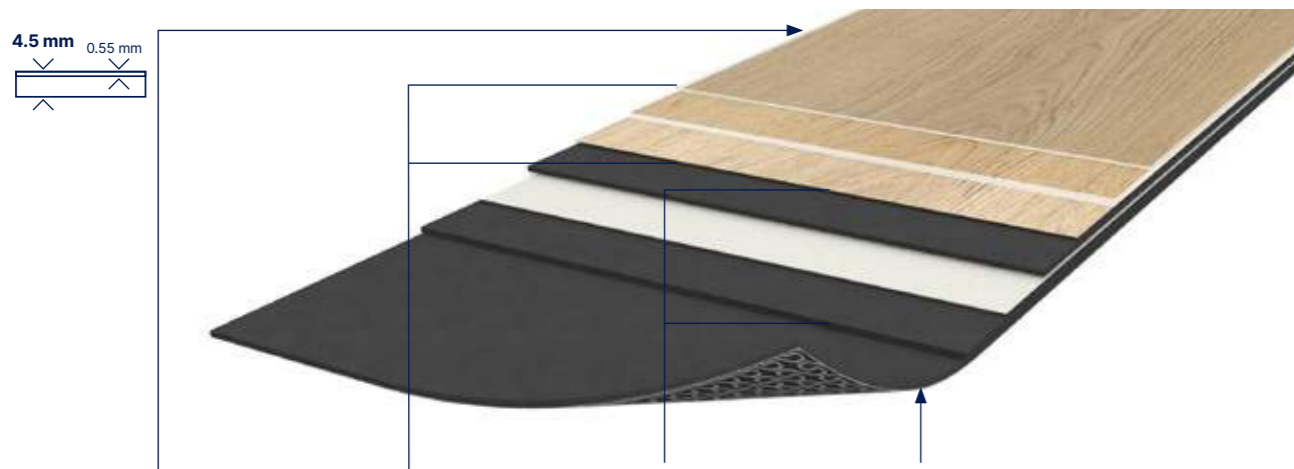

4.5 mm  
0.55 mm

### PROTECSHIELD™

#### ENHANCED PERFORMANCES

- Micro scratch resistance
- Easy maintenance

#### ULTRA MATT SURFACE

- Natural look

### 4D DESIGN

#### CRYSTAL WEAR LAYER



Authentic Look

#### HIGH DEFINITION PRINTED FILM



Ultra realism

#### STRUCTURED EMBOSS



Ultra realistic surface

#### BEVELLED EDGES



Tiles & Planks effect

### RESILIENT CORE BOARD

#### RENOVATION



Over ceramic tiles  
4mm/2mm

#### DIMENSIONAL STABILITY



Free adhesive  
installation up to  
30sqm

#### RESILIENT COMFORT CORE



Acoustic comfort



Walking comfort

#### REMOVABLE



suitable for raised  
access Floor

### WAFFLE BACKING



Perfect adherence  
to the subfloor



No moisture if water  
infiltration



100% Reach  
Phthalate free



100% Recyclable  
Up to 35% recycled content



TVOC emissions below  
detection level  
(TVOC < 10µg/m³ after 28 days)  
No formaldehyde

Formats (mm)



Looselay  
Removable

## Creation 55 Looselay

**Creation 55 Looselay** is a synthetic, decorative, flexible, antistatic, abrasion group T floorcovering available in tiles and planks. It consists in a 0.55 mm thick transparent wear layer, a design film and a Duo Core Technology, made with a rigid core back layer reinforced with a fiber veil, combined with a flexible core top layer to provide softness and comfort surface. The overall thickness is 4.5 mm. It also includes anti-skid backing to allow an easy installation and a glue-free installation up to 30 sqm. It benefits from a cross-linked polyurethane surface treatment (**Protecshield™**), making maintenance easier and eliminating the need for initial polishes.

**Creation 55 Looselay** is a looselay floorcovering, resistant to use (commercial / industrial use) of 33-42 according to EN-ISO 10874 and has Bfl-s1 class for smoke emission according to EN 13501-1.

**Creation 55 Looselay** is made with phthalate free plasticizers, except recycled content. It is 100% recyclable and made with 35% of recycled content. It is REACH compliant. **The product emission rate of organic compounds is < 10 microgram/m³** (TVOC < 28 days – ISO 16000-6).

## Explore the world of possibilities

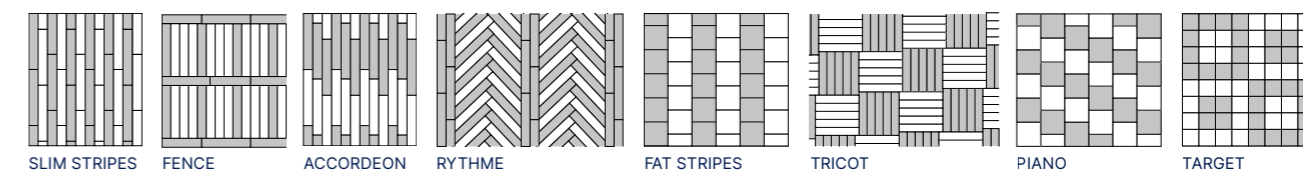

## Quick & Easy to install



Installation with tackifier

Apply planks or tiles

Pressure roller

Easy to replace a plank

Please refer to Gerflor's installation guidelines.

### Creation 55 Looselay

#### Description

Total thickness	EN ISO 24346	mm	4.50
Thickness of wearlayer	EN ISO 24340	mm	0.55
Weight	EN ISO 23997	g/sqm	7500
Size	EN ISO 24342	mm	229x1220 152x914 600x600 914x914
Number of planks / tiles and sqm per box	-	-	6 / 1.67 m² 12 / 1.67 m² 6 / 2.16 m² 4 / 3.34 m²

#### Classification

Norm / Product specification	-	-	EN ISO 10582
European classification	EN ISO 10874	class	33-42
Fire rating	EN 13501-1	class	Bfl-s1
Static electrical propensity	EN 1815	kV	< 2
Slip resistance wet: ramp test with oil	EN 16165:2021 – Appendix B (DIN 51 130)	class	R10

#### Performances

Wear resistance	EN 660.2	mm³	≤ 2.0
Wear group	-	group	T
Type Binder content	ISO 10582	type	1
Room impact	NF S 31074	dB	74
Room sound insulation	EN ISO 717-2	dB	7
Dimensional stability (norm)	EN ISO 23999	%	≤ 0.15
Dimensional stability (average measured value)	EN ISO 23999	%	≈ 0.05
Residual indentation	EN ISO 24343-1	mm	≤ 0.10
Castor chair test (type H)	ISO 4918	-	OK
Thermal conductivity	EN ISO 10456	W/(m.k)	0.25
Colour fastness	EN ISO 105-B02	degree	≥ 6
Surface treatment	-	-	ProtecShield™
Chemical products resistance	EN ISO 26987	-	OK

#### Environment / indoor air quality

TVOC after 28 days	ISO 16000-6	microgram/m³	< 10
--------------------	-------------	--------------	------

#### CE marking



EN 14041





# Creation Tiles & planks

## Creation 55 Looselay Acoustic New

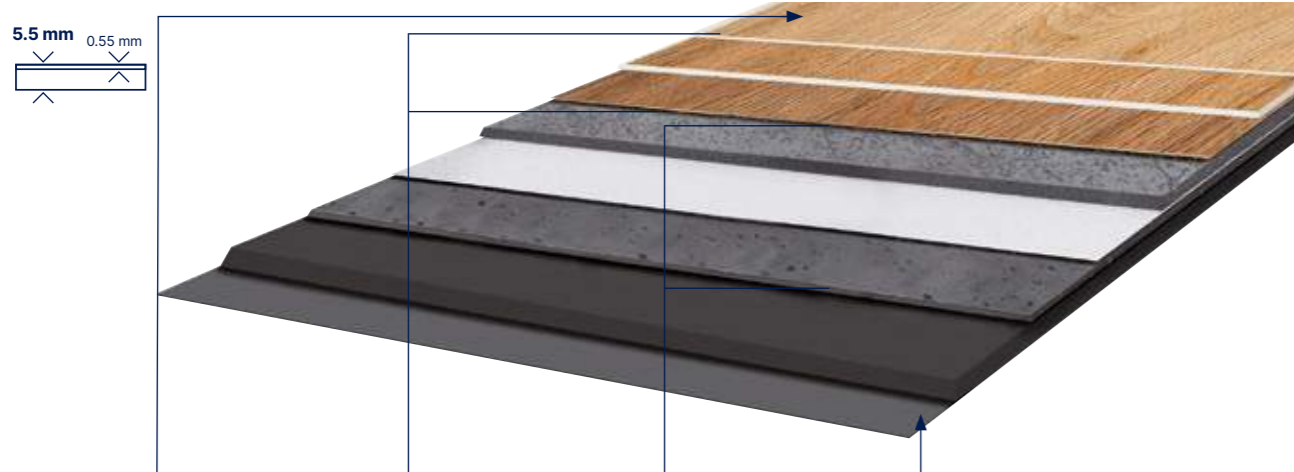

5.5 mm  
0.55 mm

### PROTECSHIELD™

#### ENHANCED PERFORMANCES

Micro scratch resistance



Easy maintenance

#### ULTRA MATT SURFACE

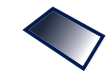

Natural look

### 4D DESIGN

#### CRYSTAL WEAR LAYER



Authentic Look

#### HIGH DEFINITION PRINTED FILM



Ultra realism

#### STRUCTURED EMOSS



Ultra realistic surface

#### BEVELLED EDGES



Tiles & Planks effect

### RESILIENT CORE BOARD

#### RENOVATION



Over ceramic tiles  
4mm/2mm

#### DIMENSIONAL STABILITY



Free adhesive installation up to  
30sqm

#### RESILIENT COMFORT CORE



Acoustic comfort



Walking comfort

#### REMOVABLE



suitable for raised access floor

### WAFFLE BACKING



Perfect adherence to the subfloor



No moisture if water infiltration

### INTEGRATED ACOUSTIC UNDERLAY

#### ACOUSTIC UNDERLAYER



Sound insulation 19dB



100% Reach Phthalate free



100% Recyclable  
Up to 35% recycled content



TVOC emissions below detection level  
(tvoc < 10µg/m³ after 28 days)  
No formaldehyde

Formats (mm)



Looselay Removable

## Creation 55 Looselay Acoustic

**Creation 55 Looselay Acoustic** is a synthetic, decorative, flexible, antistatic, abrasion group T floorcoverings available in tiles and planks with bevelled edges. It consists in a 0.55 mm thick transparent wear layer, a design film and a Duo Core Technology, made with a rigid core back layer reinforced with a fiber veil, combined with a flexible core top layer to provide softness and comfort surface. The backing integrates an acoustic core reaching 19 dB acoustic impact noise reduction. The overall thickness is 5.5 mm. They benefit from a cross-linked polyurethane surface treatment (**Protecshield™**), making maintenance easier and

eliminating the need for initial polishes.

**Creation 55 Looselay Acoustic** is a looselay floorcovering, resistant to use (commercial / industrial use) of 33-42 according to EN-ISO 10874 and has Bfl-s1 class for smoke emission according to EN 13501-1.

**Creation 55 Looselay Acoustic** is made with phthalate free plasticizers, except recycled content. It is 100% recyclable and made with 35% of recycled content. It is REACH compliant. **The product emission rate of organic compounds is < 10 microgram/m³** (TVOC < 28 days – ISO 16000-6).

## Explore the world of possibilities

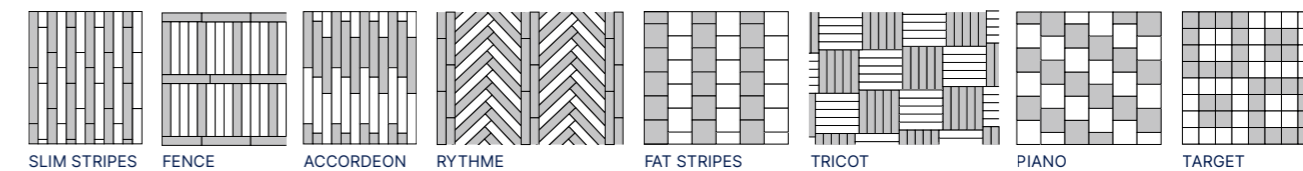

## Quick & Easy to install



Installation with tackifier

Apply planks or tiles

Pressure roller

Easy to replace a plank

Please refer to Gerflor's installation guidelines.

### Creation 55 Looselay Acoustic

#### Description

Total thickness	EN ISO 24346	mm	5.50
Thickness of wearlayer	EN ISO 24340	mm	0.55
Weight	EN ISO 23997	g/sqm	7600
Size	EN ISO 24342	mm	228.6×1220      600×600
Number of planks / tiles and sqm per box	-	-	8 / 2.23 m²      6 / 2.16 m²

#### Classification

Norm / Product specification	-	-	ISO 10582
European classification	EN ISO 10874	class	33-42
Fire rating	EN 13501-1	class	Bfl-s1
Static electrical propensity	EN 1815	kV	< 2
Slip resistance wet: ramp test with oil	EN 16165:2021 – Appendix B (DIN 51 130)	class	R10

#### Performances

Wear resistance	EN 660.2	mm³	≤ 2.0
Wear group	-	group	T
Type Binder content	EN ISO 10582	type	1
Room impact	NF S 31074	dB	70
Room sound insulation	EN ISO 717-2	dB	19
Dimensional stability (norm)	EN ISO 23999	%	≤ 0.15
Dimensional stability (average measured value)	EN ISO 23999	%	≈ 0.05
Residual indentation	EN ISO 24343-1	mm	≤ 0.10
Castor chair test (type H)	ISO 4918	-	OK
Thermal conductivity	EN ISO 10456	W/(m.k)	0.25
Colour fastness	EN ISO 105-B02	degree	≥ 6
Surface treatment	-	-	ProtecShield™
Chemical products resistance	EN ISO 26987	-	OK

#### Environment / indoor air quality

TVOC after 28 days	ISO 16000-6	microgram/m³	< 10
--------------------	-------------	--------------	------

#### CE marking



EN 14041





# Creation Tiles & planks

Creation 55 HB 



Bostonian Oak Beige



Quartet 0503  
DB 152 x 762 | RIGID AC 125 x 750



Quartet Fauve 0859  
DB 152 x 762



Ballerina 0347  
DB 152 x 762 | RIGID AC 125 x 750



Twist 0504  
DB 152 x 762



Bostonian Oak Beige 0853  
DB 152 x 762



Quartet & Quartet Fauve

DB  
Creation 55  
(Dry Back)

RIGID AC  
Creation 55  
Rigid Acoustic

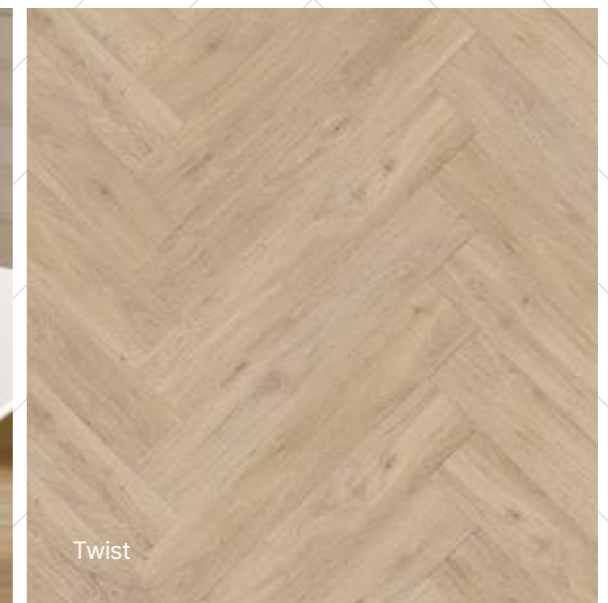

Twist



Ballerina



Quartet Fauve



# Creation Tiles & planks

Creation 55 Looselay HB 

LL  
Creation 55 Looselay



Tamo Natural / Tamo Clear / Tamo Light Brown



Gentleman Cream 1563 **New**  
LL 152 x 914

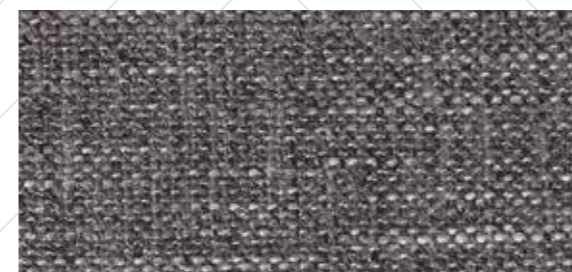

Gentleman Grey 1058 **New**  
LL 152 x 914



Tamo Light 1559 **New**  
LL 152 x 914



Tamo Clear 1567 **New**  
LL 152 x 914



Tamo Light Brown 1568 **New**  
LL 152 x 914



Creation  
Tiles & planks



# Creation Tiles & planks

Creation 55 EIR



**DB**  
Creation 55  
(Dry Back)

**SOLID CLIC**  
Creation 55  
Solid Clic

**RIGID AC**  
Creation 55  
Rigid Acoustic



Charming Oak Brown 1280  
**DB** 184 × 1219 | **SOLID CLIC** 212 × 1239 | **RIGID AC** 177 × 1219



Lounge Oak Chestnut 1274  
**DB** 230 × 1500 | **SOLID CLIC** 240 × 1461 | **RIGID AC** 225 × 1524



White Lead Oak Dark Beige 1289  
**DB** 184 × 1219



Charming Oak Nature 1277  
**DB** 184 × 1219 | **SOLID CLIC** 212 × 1239 | **RIGID AC** 177 × 1219



Lounge Oak Golden 1271  
**DB** 230 × 1500 | **SOLID CLIC** 240 × 1461 | **RIGID AC** 225 × 1524



White Lead Oak Blond 1288  
**DB** 184 × 1219



Charming Oak Beige 1278  
**DB** 184 × 1219 | **SOLID CLIC** 212 × 1239 | **RIGID AC** 177 × 1219



Lounge Oak Natural 1273  
**DB** 230 × 1500 | **SOLID CLIC** 240 × 1461 | **RIGID AC** 225 × 1524



White Lead Oak Shadow Grey 1290  
**DB** 184 × 1219



Charming Oak Grey 1279  
**DB** 184 × 1219 | **SOLID CLIC** 212 × 1239 | **RIGID AC** 177 × 1219



Lounge Oak Beige 1272  
**DB** 230 × 1500 | **SOLID CLIC** 240 × 1461 | **RIGID AC** 225 × 1524



Creation  
Tiles & planks



# Creation Tiles & planks

## Creation 55

**DB**  
Creation 55  
(Dry Back)

**SOLID CLIC**  
Creation 55  
Solid Clic

**RIGID AC**  
Creation 55  
Rigid Acoustic

**LL**  
Creation 55  
Looselay

**LL AC**  
Creation 55  
Looselay Acoustic



Brownie 0459  
**DB** 184 × 1219



Buffalo 0457  
**DB** 184 × 1219 | **SOLID CLIC** 212 × 1239



Long Board 0455  
**DB** 184 × 1219 | **SOLID CLIC** 212 × 1239 | **RIGID AC** 177 × 1219  
**LL** 229 × 1220 | **LL AC** 229 × 1220



Bostonian Oak 0871  
**DB** 184 × 1219 | **SOLID CLIC** 212 × 1239 | **RIGID AC** 177 × 1219



Amarante 0579  
**DB** 184 × 1219



Ballerina 0347  
**DB** 184 × 1219 / 152 × 762 | **SOLID CLIC** 212 × 1239  
**RIGID AC** 177 × 1219 / 125 × 750 | **LL** 229 × 1220 | **LL AC** 229 × 1220



Michigan 0461  
**DB** 184 × 1219 | **SOLID CLIC** 212 × 1239 | **RIGID AC** 177 × 1219



Cedar Brown 0850  
**DB** 230 × 1500 | **SOLID CLIC** 240 × 1461 | **RIGID AC** 225 × 1524



Quartet Honey 0870  
**DB** 184 × 1219 | **SOLID CLIC** 212 × 1239 | **RIGID AC** 177 × 1219



Quartet 0503  
**DB** 184 × 1219 / 152 × 762 | **SOLID CLIC** 212 × 1239  
**RIGID AC** 177 × 1219 / 125 × 750



Bostonian Oak Honey 0851  
**DB** 184 × 1219 | **SOLID CLIC** 212 × 1239 | **RIGID AC** 177 × 1219



Honey Oak 0441  
**DB** 184 × 1219 | **SOLID CLIC** 212 × 1239 | **RIGID AC** 177 × 1219  
**LL** 229 × 1220



Creation  
Tiles & planks



# Creation Tiles & planks

## Creation 55

LL  
Creation 55 Looselay

LL AC  
Creation 55 Looselay  
Acoustic



Tamo Light Brown 1568 **New**  
LL 229x1220 / 152x914



Tamo Light 1559 **New**  
LL 229x1220 / 152x914 | LL AC 229x1220



Tamo Dainty 1560 **New**  
LL 229x1220 | LL AC 229x1220



Tamo Natural 1561 **New**  
LL 229x1220 | LL AC 229x1220



Tamo Clear 1567 **New**  
LL 229x1220 / 152x914



Tamo Dainty



# Creation Tiles & planks

## Creation 55



Rustic Oak 0445  
**DB** 184 × 1219 | **SOLID CLIC** 212 × 1239 | **RIGID AC** 177 × 1219



Cambridge 0465  
**DB** 184 × 1219 | **SOLID CLIC** 212 × 1239



Quartet Fauve 0859  
**DB** 184 × 1219 / 152 × 762 | **SOLID CLIC** 212 × 1239  
**RIGID AC** 177 × 1219



Swiss Oak Golden 0796  
**DB** 184 × 1219 | **SOLID CLIC** 212 × 1239 | **RIGID AC** 177 × 1219  
**LL** 229 × 1220



Cambridge

**DB**  
 Creation 55  
 (Dry Back)

**SOLID CLIC**  
 Creation 55  
 Solid Clic

**RIGID AC**  
 Creation 55  
 Rigid Acoustic

**LL**  
 Creation 55  
 Looselay

**LL AC**  
 Creation 55  
 Looselay Acoustic



Mansfield Natural 0069  
**DB** 184 × 1219



Bostonian Oak Beige 0853  
**DB** 184 × 1219 / 152 × 762 | **SOLID CLIC** 212 × 1239  
**RIGID AC** 177 × 1219



Swiss Oak Beige 0848  
**DB** 184 × 1219 | **SOLID CLIC** 212 × 1239 | **RIGID AC** 177 × 1219



Malua Bay 0448  
**DB** 184 × 1219 | **SOLID CLIC** 212 × 1239 | **RIGID AC** 177 × 1219



Twist 0504  
**DB** 184 × 1219 / 152 × 762 | **SOLID CLIC** 212 × 1239  
**RIGID AC** 177 × 1219 | **LL** 229 × 1220



Cedar Pure 0849  
**DB** 230 × 1500 | **SOLID CLIC** 240 × 1461 | **RIGID AC** 225 × 1524



Salento Light Grey 1287  
**DB** 184 × 1219 | **SOLID CLIC** 212 × 1239 | **RIGID AC** 177 × 1219



Salento Beige 1286  
**DB** 184 × 1219 | **SOLID CLIC** 212 × 1239 | **RIGID AC** 177 × 1219



# Creation Tiles & planks

## Creation 55



Swiss Oak Pearl 0846  
**DB** 184 × 1219 | **SOLID CLIC** 212 × 1239 | **RIGID AC** 177 × 1219



Oxford 0061  
**DB** 184 × 1219 | **SOLID CLIC** 212 × 1239



Palissandro Grey 1281  
**DB** 230 × 1500 | **SOLID CLIC** 240 × 1461



Amador 0447  
**DB** 184 × 1219 | **SOLID CLIC** 212 × 1239 | **RIGID AC** 177 × 1219



White Lime 0584  
**DB** 184 × 1219 | **SOLID CLIC** 212 × 1239 | **RIGID AC** 177 × 1219



Mansfield Light 0068  
**DB** 184 × 1219



Arena 0060  
**DB** 184 × 1219 | **SOLID CLIC** 212 × 1239



Ranch 0456  
**DB** 184 × 1219 / 230 × 1500 | **SOLID CLIC** 212 × 1239 / 240 × 1461  
**RIGID AC** 177 × 1219 | **LL** 229 × 1220 | **LL AC** 229 × 1220



Palissandro Beige

**DB**  
 Creation 55  
 (Dry Back)

**SOLID CLIC**  
 Creation 55  
 Solid Clic

**RIGID AC**  
 Creation 55  
 Rigid Acoustic

**LL**  
 Creation 55  
 Looselay

**LL AC**  
 Creation 55  
 Looselay Acoustic



Stripe Oak Ice 0858  
**DB** 184 × 1219 | **SOLID CLIC** 212 × 1239



Palissandro Beige 1282  
**DB** 230 × 1500 | **SOLID CLIC** 240 × 1461



Paint Wood Taupe 0856  
**DB** 184 × 1219 | **SOLID CLIC** 212 × 1239



# Creation Tiles & planks

## Creation 55



Urban Street Terra / Gentleman Terra

**DB**  
Creation 55  
(Dry Back)

**SOLID CLIC**  
Creation 55  
Solid Clic

**RIGID AC**  
Creation 55  
Rigid Acoustic

**LL**  
Creation 55  
Looselay

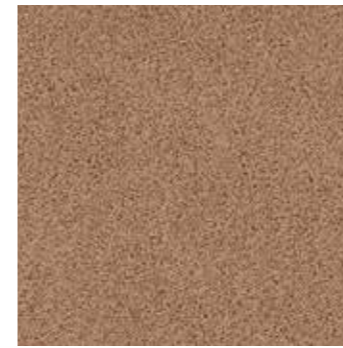

Urban Street Terra 1566  
**New**  
LL 600 × 600



Gentleman Terra 1564  
**New**  
LL 600 × 600



Curton Stone Light Grey 1275  
**DB** 457 × 914 | **SOLID CLIC** 389 × 729  
**RIGID AC** 457 × 914



Urban Street Cream 1565  
**New**  
LL 600 × 600

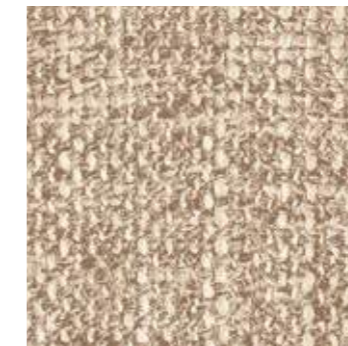

Gentleman Cream 1563  
**New**  
LL 600 × 600 / 152 × 914



Urban Street Beige 1285  
**DB** 914 × 914

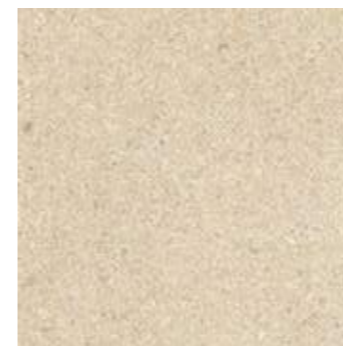

Curton Stone Light Beige 1276  
**DB** 457 × 914 | **SOLID CLIC** 389 × 729  
**RIGID AC** 457 × 914



Fabrik Mix Jute 1268  
**DB** 610 × 610 | **SOLID CLIC** 389 × 729



Bloom Uni Taupe 0868  
**DB** 610 × 610 | **SOLID CLIC** 389 × 729  
**RIGID AC** 457 × 914 | **LL** 600 × 600



# Creation Tiles & planks

## Creation 55

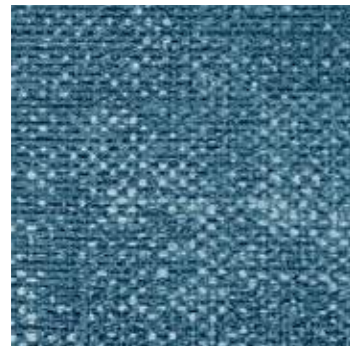

Fabrik Mix Indigo 1270  
DB 610 x 610



Silver City 0373  
DB 610 x 610



Parker Station 0374  
DB 610 x 610 | **SOLID CLIC** 389 x 729  
RIGID AC 457 x 914 | LL 914 x 914

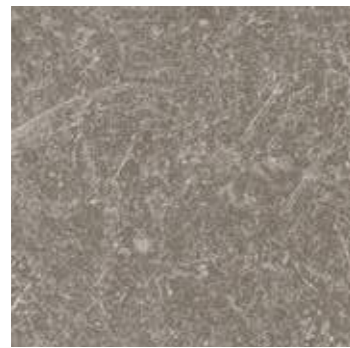

Carmel 0618  
DB 457 x 914 | **SOLID CLIC** 389 x 729  
RIGID AC 457 x 914



Riverside 0436  
DB 610 x 610 | **SOLID CLIC** 389 x 729  
RIGID AC 457 x 914 | LL 600 x 600

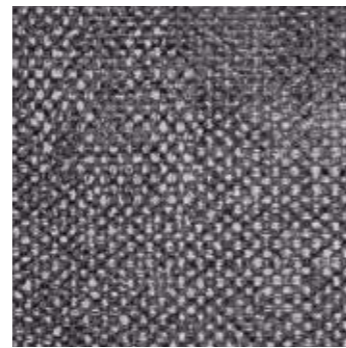

Fabrik Mix Dark Grey 1269  
DB 610 x 610 | **SOLID CLIC** 389 x 729

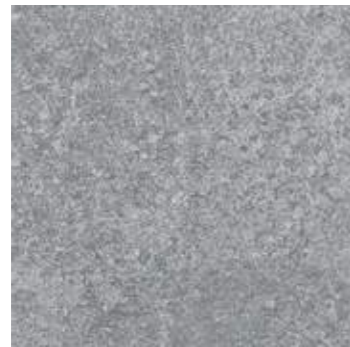

Bloom Uni Grey 0869  
DB 610 x 610 | **SOLID CLIC** 389 x 729  
RIGID AC 457 x 914



Urban Street Medium 1284  
DB 914 x 914 | **SOLID CLIC** 389 x 729  
LL 914 x 914 | **LL AC** 600 x 600



Urban Street Light 1283  
DB 914 x 914 | **SOLID CLIC** 389 x 729  
LL 914 x 914 | **LL AC** 600 x 600



Gentleman Grey / Urban Street Light

**DB**  
Creation 55  
(Dry Back)

**SOLID CLIC**  
Creation 55  
Solid Clic

**RIGID AC**  
Creation 55  
Rigid Acoustic

**LL**  
Creation 55  
Looselay

**LL AC**  
Creation 55  
Looselay Acoustic

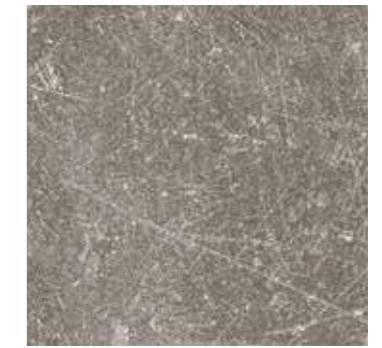

Dock Taupe 0087  
**New**  
LL 914 x 914

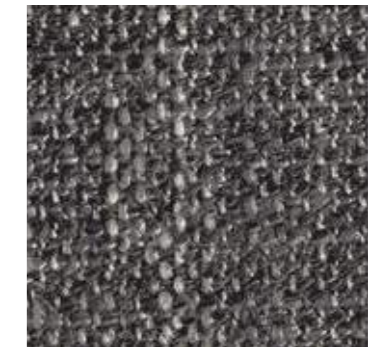

Gentleman Grey 1058  
**New**  
LL 600 x 600 / 152x914











Gentleman Taupe 1083  
**New**  
LL 600 x 600



# Creation Tiles & planks

## Creation 55

Code	Color Design	Dry Back	Solid Clic	Rigid Acoustic	Looselay	Looselay Acoustic	Skirting Matching Design	Coverstrip Matching Design	Emboss	NCS	LRV
											
0447	Amador	184 x 1219	212 x 1239	177 x 1219**	-	-	S004	S004	Saw Effect	5005-Y50R	25.1
0579	Amarante	184 x 1219	-	-	-	-	S005	S001	Brushed	5010-Y30R	21.3
0060	Arena	184 x 1219	212 x 1239	-	-	-	S026	S001	Saw Effect	4005-Y20R	37.2
0347	Ballerina	184 x 1219 152 x 762	212 x 1239	177 x 1219 125 x 750	229 x 1220	229 x 1220	S008	S008	Natural	4040-Y20R	28.4
0869	Bloom Uni Grey	610 x 610	389 x 729	457 x 914	-	-	S071	S071	Hammered	5005-B20G	23.2
0868	Bloom Uni Taupe	610 x 610	389 x 729	457 x 914	600 x 600	-	S072	S072	Hammered	4502-Y	28.5
0871	Bostonian Oak	184 x 1219	212 x 1239	177 x 1219	-	-	S016	S016	Natural	5020-Y20R	26.4
0853	Bostonian Oak Beige	184 x 1219 152 x 762	212 x 1239	177 x 1219	-	-	S017	S017	Natural	4005-Y20R	36.7
0851	Bostonian Oak Honey	184 x 1219	212 x 1239	177 x 1219	-	-	S019	S019	Natural	4020-Y20R	29.8
0459	Brownie	184 x 1219	-	-	-	-	S073	S001	Natural	6020-Y30R	10.7
0457	Buffalo	184 x 1219	212 x 1239	-	-	-	S075	S001	Brushed	6010-Y10R	16.3
0465	Cambridge	184 x 1219	212 x 1239	-	-	-	S065	S001	Natural	3030-Y20R	39.8
0618	Carmel	457 x 914	389 x 729	457 x 914	-	-	S020	S020	Hammered	6005-Y50R	19.2
0850	Cedar Brown	230 x 1500	240 x 1461	225 x 1524	-	-	S024	S024	Natural	5020-Y20R	21.3
0849	Cedar Pure	230 x 1500	240 x 1461	225 x 1524	-	-	S025	S025	Natural	3010-Y30R	39.8
1278	Charming Oak Beige	184 x 1219	212 x 1239	177 x 1219	-	-	S188	S001	EIR - Charming Oak	4010-Y50R	31.5
1280	Charming Oak Brown	184 x 1219	212 x 1239	177 x 1219	-	-	S191	S001	EIR - Charming Oak	6010-Y70R	13.4
1279	Charming Oak Grey	184 x 1219	212 x 1239	177 x 1219	-	-	S190	S001	EIR - Charming Oak	3000-N	36.2
1277	Charming Oak Nature	184 x 1219	212 x 1239	177 x 1219	-	-	S192	S001	EIR - Charming Oak	5010-Y30R	18.6
1276	Curton Stone Light Beige	457 x 914	389 x 729	457 x 914 *	-	-	S184	S184	Stone	2010-Y40R	48.9
1275	Curton Stone Light Grey	457 x 914	389 x 729	457 x 914 *	-	-	S185	S185	Stone	3005-Y20R	45.9
0087	Dock Taupe	-	-	-	914 x 914	-	S020	C019	Hammered	6005-Y50R	19.2
1269	Fabrik Mix Dark Grey	610 x 610	389 x 729	-	-	-	S165	S001	Hammered	6005-R50B	13.4
1270	Fabrik Mix Indigo	610 x 610	-	-	-	-	S166	S001	Hammered	5020-B	17.1
1268	Fabrik Mix Jute	610 x 610	389 x 729	-	-	-	S167	S001	Hammered	5005-Y50R	26.3
1563	Gentleman Cream	-	-	-	600 x 600 152 x 914	-	-	-	Textile	3010-Y40R	40.1
1058	Gentleman Grey	-	-	-	600 x 600 152 x 914	-	-	-	Textile	7500-N	12.7
1083	Gentleman Taupe	-	-	-	600 x 600	-	-	-	Textile	5502-Y	21.2
1564	Gentleman Terra	-	-	-	600 x 600	-	-	-	Textile	4020-Y30R	27
0441	Honey Oak	184 x 1219	212 x 1239	177 x 1219	229 x 1220	-	S033	S033	Natural	4020-Y20R	27.7
0455	Long Board	184 x 1219	212 x 1239	177 x 1219	229 x 1220	229 x 1220	S034	S034	Brushed	4010-Y30R	24.8
1272	Lounge Oak Beige	230 x 1500	240 x 1461	225 x 1524	-	-	S168	S001	EIR - Lounge Oak	4010-Y30R	33.9
1274	Lounge Oak Chestnut	230 x 1500	240 x 1461	225 x 1524	-	-	S192	S001	EIR - Lounge Oak	5010-Y30R	20.5
1271	Lounge Oak Golden	230 x 1500	240 x 1461	225 x 1524	-	-	S189	S001	EIR - Lounge Oak	5020-Y20R	23.8
1273	Lounge Oak Natural	230 x 1500	240 x 1461	225 x 1524	-	-	S189	S001	EIR - Lounge Oak	4020-Y30R	30.2
0448	Malua Bay	184 x 1219	212 x 1239	177 x 1219	-	-	S035	S035	Brushed	2502-Y	47.1
0068	Mansfield Light	184 x 1219	-	-	-	-	S190	S001	Brushed	4502-Y	31.8
0069	Mansfield Natural	184 x 1219	-	-	-	-	S188	S001	Brushed	3010-Y20R	37.7
0461	Michigan	184 x 1219	212 x 1239	177 x 1219	-	-	S038	S038	Brushed	6020-Y30R	13.5
0061	Oxford	184 x 1219	212 x 1239	-	-	-	S043	S001	Brushed	5502-Y	19.2
0856	Paint Wood Taupe	184 x 1219	212 x 1239	-	-	-	S046	S001	Brushed	5502-Y	18.9
1282	Palissandro Beige	230 x 1500	240 x 1461	-	-	-	S176	S001	Stone	4010-Y50R	32.1
1281	Palissandro Grey	230 x 1500	240 x 1461	-	-	-	S177	S001	Stone	4005-R20B	38.4
0374	Parker Station	610 x 610	389 x 729	457 x 914	914 x 914	-	S047	S047	Hammered	8000-N	12.6
0503	Quartet	184 x 1219 152 x 762	212 x 1239	125 x 750	-	-	S056	S056	Natural	5020-Y20R	19.4
0859	Quartet Fauve	184 x 1219 152 x 762	212 x 1239	177 x 1219	-	-	S057	S057	Natural	4030-Y20R	23.9
0870	Quartet Honey	184 x 1219	212 x 1239	177 x 1219	-	-	S058	S058	Natural	3040-Y20R	28.2
0456	Ranch	230 x 1500	240 x 1461	177 x 1219	229 x 1220	229 x 1220	S053	S053	Brushed	5005-Y50R	23.5
0436	Riverside	610 x 610	389 x 729	457 x 914	600 x 600	-	S032	S032	Hammered	6502-Y	16.7
0445	Rustic Oak	184 x 1219	212 x 1239	177 x 1219	-	-	S062	S062	Natural	4030-Y20R	20.4
1286	Salento Beige	184 x 1219	212 x 1239	177 x 1219	-	-	S186	S186	Natural	2010-Y40R	37.0
1287	Salento Light Grey	184 x 1219	212 x 1239	177 x 1219	-	-	S187	S187	Natural	2005-Y40R	46.6
0373	Silver City	610 x 610	-	-	-	-	S048	S001	Hammered	6502-Y	19.1
0858	Stripe Oak Ice	184 x 1219	212 x 1239	-	-	-	S009	S001	Natural	3502-Y	37.3
0848	Swiss Oak Beige	184 x 1219	212 x 1239	177 x 1219	-	-	S011	S011	Natural	3010-Y30R	40.1
0796	Swiss Oak Golden	184 x 1219	212 x 1239	177 x 1219	229 x 1220	-	S015	S015	Natural	4030-Y20R	25.8
0846	Swiss Oak Pearl	184 x 1219	212 x 1239	177 x 1219	229 x 1220	229 x 1220	S014	S014	Natural	3502-Y	36.1
1567	Tamo Clear	-	-	-	229 x 1220 152 x 914	-	S168	C006	Natural	3020-Y20R	33.3
1560	Tamo Dainty	-	-	-	229 x 1220	229 x 1220	S001	S001	Natural	4020-Y30R	24
1559	Tamo Light	-	-	-	229 x 1220 152 x 914	229 x 1220	S188	C005	Natural	3010-Y20R	36.6
1568	Tamo Light Brown	-	-	-	229 x 1220 152 x 914	-	S202	C003	Natural	5020-Y30R	17.2
1561	Tamo Natural	-	-	-	229 x 1220	229 x 1220	S016	C004	Natural	4020-Y20R	24.4
0504	Twist	184 x 1219 152 x 762	212 x 1239	177 x 1219	229 x 1220	-	S039	S039	Natural	3010-Y30R	38.9
1285	Urban Street Beige	914 x 914	-	-	-	-	S178	S001	Hammered	4005-Y50R	31.2
1565	Urban Street Cream	-	-	-	600 x 600	-	S178	S001	Hammered	2005-Y20R	50
1283	Urban Street Light	914 x 914	389 x 729	-	914 x 914	600 x 600	S094	S001	Hammered	3502-R	42.3
1284	Urban Street Medium	914 x 914	389 x 729	-	914 x 914	600 x 600	S180	S001	Hammered	4502-R	26.5
1566	Urban Street Terra	-	-	-	600 x 600	-	S001	S001	Hammered	5020-Y50R	21.6
1288	White Lead Oak Blond	184 x 1219	-	-	-	-	S181	S001	EIR - White Lead Oak	3010-Y40R	29.6
1289	White Lead Oak Dark Beige	184 x 1219	-	-	-	-	S182	S001	EIR - White Lead Oak	5010-Y10R	25.3
1290	White Lead Oak Shadow Grey	184 x 1219	-	-	-	-	S190	S001	EIR - White Lead Oak	3502-Y	34.6
0584	White Lime	184 x 1219	212 x 1239	177 x 1219 **	-	-	S074	S074	Saw Effect	4005-Y20R	36.0

\* Hammered emboss in Rigid Acoustic  
 \*\* Brushed emboss in Rigid Acoustic / Looselay / Looselay Acoustic

S001: White  
 S001: Aluminium

## Packaging

Product size (mm)	m <sup>2</sup> /box	m <sup>2</sup> /palette
<b>Creation 55 (Dry Back) Trend</b>		
184.15 x 1219.2	3.36	215.04
230 x 1500	3.11	214.59
152 x 762	3.82	213.92
457.2 x 914.4	3.76	218.08
609.6 x 609.6	3.35	187.60
<b>Creation 55 (Dry Back) Design</b>		
184.15 x 1219.2	3.36	215.04
230 x 1500	3.11	214.59
914.4 x 914.4	4.18	192.28

Product size (mm)	m <sup>2</sup> /box	m <sup>2</sup> /palette
<b>Creation 55 Solid Clic</b>		
212 x 1238.8	1.84	104.8
239.6 x 1460.8	2.1	100.8
388.8 x 728.7	1.7	102
<b>Creation 55 Rigid Acoustic</b>		
125 x 750	1.50	84
177 x 1219	1.73	96.88
225 x 1524	1.71	92.34
457 x 914	1.67	93.52

Product size (mm)	m <sup>2</sup> /box	m <sup>2</sup> /palette
<b>Creation 55 Looselay</b>		
229 x 1220	1.67	113.6
152 x 914	1.67	110.2
600 x 600	2.16	103.7
914 x 914	3.34	116.9
<b>Creation 55 Looselay Acoustic</b>		
229x1220	2.23	124.9
600x600	2.16	103.7

## Exclusive embosses for enhanced designs

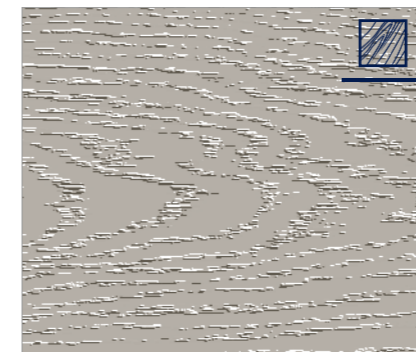

EIR - Charming Oak



Stone



Hammered



EIR - White Lead Oak



Saw effect



Natural

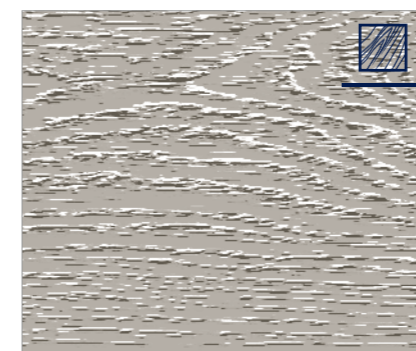

EIR - Lounge Oak



Brushed



Emboss in register



# Creation Tiles & planks

## Creation 40

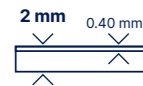

### PROTECSHIELD™

#### ENHANCED PERFORMANCES



#### ULTRA MATT SURFACE



### 4D DESIGN

#### CRYSTAL WEAR LAYER



#### HIGH DEFINITION PRINTED FILM



#### STRUCTURED EMBOSS



#### BEVELLED EDGES



### RESILIENT COMFORT CORE



## Creation Tiles & planks decoratives strips

Format (mm) 4×914mm



Code: 3203 + Color code

✓ REACH  
100% Reach Phthalate free

♻️  
100% Recyclable  
Up to 35% recycled content

🦋  
TVOC emissions below detection level  
(TVOC < 10µg/m³ after 28 days)  
No formaldehyde

Formats (mm) 184×1219 230×1500 610×610 457×914



## Creation 40

**Creation 40 Trend** is a synthetic, decorative, flexible, antistatic abrasion group T floorcoverings available in tile or plank, with bevelled edges. It consists in a 0,4 mm thick transparent wear layer, a design film and a Resilient Comfort Core to provide softness and comfort surface. The overall thickness is 2 mm. They benefit from a cross-linked polyurethane surface treatment (**Protecshield™**), making maintenance easier and prevent from micro scratches.

**Creation 40 Trend** is a glued floorcovering, resistant to use (residential / commercial use) of 23 / 32 according to EN-ISO 10874 and has Bfl -s1 class for smoke emission according to EN 13501-1.

**Creation 40 Trend** is made with phthalate free plasticizers, except recycled content. It is 100% recyclable and made with 35% of recycled content. It is 100% compliant with REACH.

**The product emission rate of organic compounds is < 10 microgram/m³ (TVOC < 28 days – ISO 16000-6).**

Can be combined with pre-adhesive underlayer

Gerflor Smart Fix 16 dB



Code: 1698 - Format: 1m x 7.5m

Please refer to Gerflor's installation guidelines.

### Creation 40

#### Creation 40 Trend

#### Description

Total thickness	EN ISO 24346	mm	2
Thickness of wearlayer	EN ISO 24340	mm	0.40
Weight	EN ISO 23997	g/sqm	3 180
Size	EN ISO 24342	mm	Planks - 184,15×1219,2 / 230×1500 Tiles - 457,2×914,4 / 609,6×609,6
Number of planks / tiles and sqm per box	-	-	21-13-11-13 / 4,71-4,49-4,6-4,83

#### Classification

Norm / Product specification	-	-	EN ISO 10582
European classification	EN ISO 10874	class	23 - 32 - 41
Fire rating	EN 13501-1	class	Bfl-s1
Static electrical propensity	EN 1815	kV	< 2
Slip resistance wet: ramp test with oil	EN 16165:2021 – Appendix B (DIN 51 130)	class	R10

#### Performances

Wear resistance	EN 660.2	mm³	≤ 2.0
Wear group	-	group	T
Type Binder content	ISO 10582	type	I
Room impact	NF S 31074	dB	77
Impact sound insulation	EN ISO 717-2	dB	4
Dimensional stability (norm)	EN ISO 23999	%	≤ 0.25
Dimensional stability (average measured value)	-	%	≤ 0.10
Residual indentation	EN ISO 24343-1	mm	≤ 0.10
Castor chair test (type H)	ISO 4918	-	OK
Thermal conductivity	EN ISO 10456	W/(m.k)	0.25
Colour fastness	EN ISO 105-B02	degree	≥ 6
Surface treatment	-	-	ProtecShield™
Chemical products resistance	EN ISO 26987	-	OK

#### Environment / indoor air quality

TVOC after 28 days	ISO 16000-6	microgram/m³	< 10
Certification	-	-	Floorscore®

#### CE marking



EN 14041





# Creation Tiles & planks

## Creation 40 Solid Clic

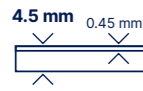

Formats (mm) 212x1238 240x1461 388x729 |



### Creation 40 Solid Clic

**Creation 40 Solid Clic** is a decorative, flexible, abrasion group T floorcoverings available in tiles and planks, with bevelled edges. It consists in a 0,45 mm thick transparent wear layer, a design film of 2 m width printed in high definition to have more variety in the design and the technology "Duo Core 2.0": combination of a rigid core back layer for easy renovation and a flexible core top layer to provide softness and comfort surface, the whole with a double reinforcement for enhanced durability. The overall thickness is 4,5 mm. They benefit from a cross-linked polyurethane surface treatment (**Protecshield™**), making maintenance easier and avoiding microscratches.

**Creation 40 Solid Clic** is an interlocking floorcovering assembled with a vertical system on the short side and a horizontal system on long side for a quick and solid installation. It has a European class (residential / commercial / industrial use) 23/32/41 according to EN-ISO 10874 and has Bfl -s1 class for smoke emission according to EN 13501-1. **Creation 40 Solid Clic** is made with phthalate free plasticizers (except recycled content). It is 100% recyclable and made with a recycled content up to 55%. It is 100% compliant with REACH. **The product emission rate of organic compounds is < 10 microgram/m³ (TVOC < 28 days - ISO 16000-6).**

### To be combined with Gerflor acoustic underlayers

Gerflor Acoustic 15 dB



Code: 1798 - Format: 1m x 15ml

Gerflor Acoustic Plus 19 dB



Code: 0704 - Format: 0.98m x 15.3ml

Gerflor Silence Plus 19 dB



Code: 5949 - Format: 1.18m x 8.5ml

Please refer to Gerflor's installation guidelines.

### Creation 40 Solid Clic

Description			
Total thickness	EN ISO 24346	mm	4.50
Thickness of wearlayer	EN ISO 24340	mm	0.45
Weight	EN ISO 23997	g/sqm	7118
Size	EN ISO 24342	mm	Planks - 212x1238,8 / 239,6x1460,8 Tiles - 388,8x728,7
Number of planks / tiles and sqm per box	EN ISO 24342	mm	8-7-7/ 2,10-2,45-1,98
Classification			
Norm / Product specification	-	-	EN ISO 10582
European classification	EN ISO 10874	class	23 - 32 -41
Fire rating	EN 13501-1	class	Bfl-s1
Static electrical propensity	EN 1815	kV	< 2
Slip resistance wet: ramp test with oil	EN 16165:2021 - Appendix B (DIN 51 130)	class	R10
Performances			
Wear resistance	EN 660.2	mm³	< 2.0
Wear group	-	group	T
Type Binder content	ISO 10582	type	I
Room impact	NF S 31074	dB	79
Impact sound insulation	EN ISO 717-2	dB	4
Dimensional stability (norm)	EN ISO 23999	%	≤ 0.15
Dimensional stability (average measured value)	-	%	≤ 0.05
Residual indentation	EN ISO 24343-1	mm	≤ 0.10
Castor chair test (type H)	ISO 4918	-	OK
Thermal conductivity	EN ISO 10456	W/(m.k)	0.25
Colour fastness	EN ISO 105-B02	degree	≥ 6
Surface treatment	-	-	ProtecShield™
Chemical products resistance	EN 423	-	OK
Environment / indoor air quality			
TVOC after 28 days	ISO 16000-6	microgram/m³	< 10
Certification	-	-	Floorscore®
CE marking			



EN 14041



#### PROTECSHIELD™

##### ENHANCED PERFORMANCES



Micro scratch resistance



Easy maintenance

##### ULTRA MATT SURFACE



Natural look

#### 4D DESIGN

##### CRYSTAL WEAR LAYER



Authentic Look

##### HIGH DEFINITION PRINTED FILM



Ultra realism

##### STRUCTURED EMBOSS



Ultra realistic surface

##### BEVELLED EDGES



Tiles & Planks effect

#### DUOCORE 2.0 TECHNOLOGY

##### RESILIENT COMFORT CORE



Acoustic comfort



Walking comfort

##### NEW RIGID CORE



Renovation over ceramic tiles 6mm/2mm



Resistance against high temperature variation

#### EXCLUSIVE INTERLOCKING SYSTEM

##### ANGULAR ON LONG SIDE



Quiet installation

##### VERTICAL ON SHORT SIDE



Traffic resistance Durability



Fast & easy to install



Waterproof Joints

**100% Reach Phthalate free**

**100% Recyclable Up to 55% recycled content**

**TVOC emissions below detection level (TVOC < 10µg/m³ after 28 days) No formaldehyde**



# Creation Tiles & planks

## Creation 40 Rigid Acoustic

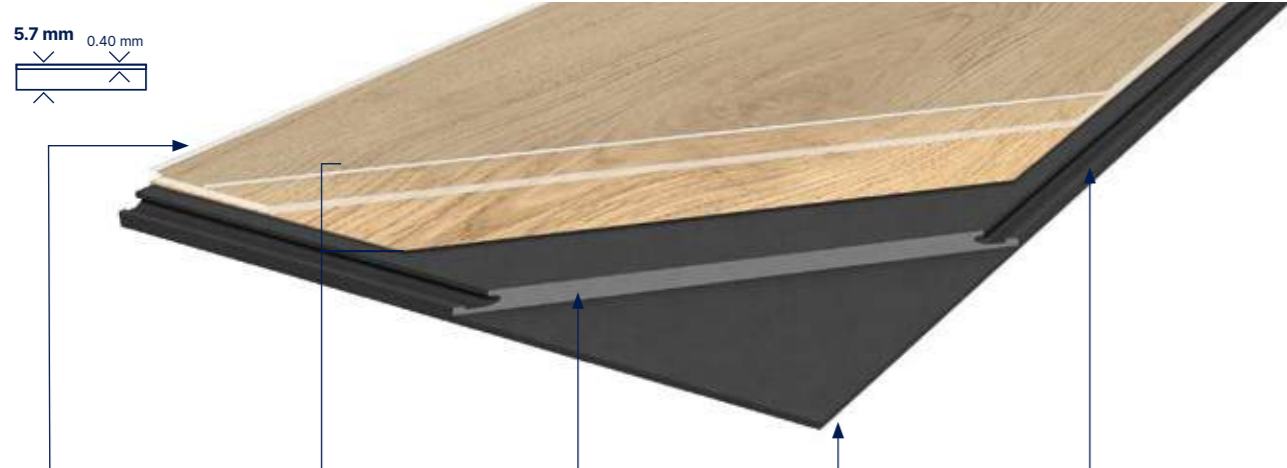

### PROTECSHIELD™

#### ENHANCED PERFORMANCES



Micro scratch resistance



Easy maintenance

#### ULTRA MATT SURFACE

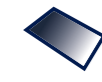

Natural look

### 4D DESIGN

#### CRYSTAL WEAR LAYER



Authentic Look

#### HIGH DEFINITION PRINTED FILM



Ultra realism

#### STRUCTURED EMOSS



Ultra realistic surface

#### BEVELLED EDGES



Tiles & Planks effect

### RCB-TECHNOLOGY PATENTED



Renovation over ceramic tiles 8mm/3mm

#### EASY INSTALLATION



Easy to handle (7kg/m<sup>2</sup>) and easy to install (30 % lighter than standard rigid planks)



Resistance against high temperature variation

### INTEGRATED ACOUSTIC UNDERLAY

#### ACOUSTIC UNDERLAYER



Sound insulation 19dB



Absorbs default of the subfloor (up to 1mm unevenness)

### INTERLOCKING SYSTEM

#### ANGLE TO ANGLE LOCKING SYSTEM



Standard laminate installation

Formats (mm)

229x1250

229x1492

399x730



## Creation 40 Rigid Acoustic

**Creation 40 Rigid Acoustic** is a decorative flooring, rigid interlocking with acoustic layer, antistatic, abrasion group T floorcoverings available in tiles and planks, with bevelled edges. It is made with:

- a 0,40 mm thick transparent wear layer to provide durability
  - a high definition printing film to provide high quality design & esthetism
  - a Rigid Composite Board Technology, new generation of rigid board with patented production process which provides a 30% less heavier product than comparable products on the market
  - an integrated underlayer 100% recyclable and which provides a 19 dB sound reduction.
- The total thickness of the product is 5,7 mm. It also

uses a cross-linked polyurethane surface treatment (**Protecshield™**), making maintenance easier, durability longer, protecting from micro scratches, and providing an ultra-mat effect for more realistic look.

**Creation 40 Rigid Acoustic** is an interlocking floorcovering assembled with an angle/angle locking system to provide robust and easy installation. It has an European class (residential/commercial) of 23/32 according to EN-ISO 10874 and has Bfl -s1 class for smoke emission according to EN 13501-1.

**Creation 40 Rigid Acoustic** is made with phthalate free plasticizers. It is 100% recyclable and made with up to 35% of recycled content. It is 100% compliant with REACH. **The product emission rate of organic compounds is < 10 microgram/m<sup>3</sup> (TVOC < 28 days – ISO 16000-6).**



### Creation 40 Rigid Acoustic

#### Description

Total thickness	EN ISO 24346	mm	5.70
Thickness of wearlayer	EN ISO 24340	mm	0.40
Weight	EN ISO 23997	g/sqm	7000
Size	EN ISO 24342	mm	Planks - 229x1250 / 229x1492 Tiles - 399x730
Number of planks / tiles and sqm per box	EN ISO 24342	mm	7-7-7/ 2-2,39-2,04

#### Classification

Norm / Product specification	-	-	EN ISO 10582
European classification	EN ISO 10874	class	23 - 32 - 41
Fire rating	EN 13501-1	class	Bfl-s1
Static electrical propensity	EN 1815	kV	< 2
Slip resistance wet: ramp test with oil	EN 16165:2021 – Appendix B (DIN 51 130)	class	R10

#### Performances

Wear resistance	EN 660.2	mm <sup>3</sup>	< 2.0
Wear group	-	group	T
Type Binder content	ISO 10582	type	I
Room impact	NF S 31074	dB	80
Impact sound insulation	EN ISO 717-2	dB	19
Dimensional stability (norm)	EN ISO 23999	%	≤ 0.15
Dimensional stability (average measured value)	-	%	≤ 0.10
Residual indentation	EN ISO 24343-1	mm	≤ 0.10
Castor chair test (type H)	ISO 4918	-	OK
Thermal conductivity	EN ISO 10456	W/(m.k)	0.25
Colour fastness	EN ISO 105-B02	degree	≥ 6
Surface treatment	-	-	ProtecShield™
Chemical products resistance	EN 423	-	OK

#### Environment / indoor air quality

TVOC after 28 days	ISO 16000-6	microgram/m <sup>3</sup>	< 10
--------------------	-------------	--------------------------	------

#### CE marking



EN 14041



100% Reach  
Phthalate free



100% Recyclable  
Up to 35% recycled content



TVOC emissions below  
detection level  
(TVOC < 10µg/m<sup>3</sup> after 28 days)  
No formaldehyde



# Creation Tiles & planks

## Creation 40

**DB** Creation 40 (Dry Back)    **SOLID CLIC** Creation 40 Solid Clic    **RIGID AC** Creation 40 Rigid Acoustic



Michigan 0461  
DB 184 × 1219 | **SOLID CLIC** 212 × 1239 | **RIGID AC** 229 × 1250



Quartet 0503  
DB 184 × 1219 | **SOLID CLIC** 212 × 1239 | **RIGID AC** 229 × 1250



Bostonian Oak Honey 0851  
DB 184 × 1219 | **SOLID CLIC** 212 × 1239 | **RIGID AC** 229 × 1250



Long Board 0455  
DB 184 × 1219 | **SOLID CLIC** 212 × 1239 | **RIGID AC** 229 × 1250



Bostonian Oak 0871  
DB 184 × 1219 | **SOLID CLIC** 212 × 1239 | **RIGID AC** 229 × 1250



Cedar Brown 0850  
DB 230 × 1500 | **SOLID CLIC** 240 × 1461 | **RIGID AC** 229 × 1492



Ballerina 0347  
DB 184 × 1219 | **SOLID CLIC** 212 × 1239 | **RIGID AC** 229 × 1250



Swiss Oak Golden 0796  
DB 184 × 1219 | **SOLID CLIC** 212 × 1239 | **RIGID AC** 229 × 1250



Rustic Oak 0445  
DB 184 × 1219 | **SOLID CLIC** 212 × 1239 | **RIGID AC** 229 × 1250



Honey Oak 0441  
DB 184 × 1219 | **SOLID CLIC** 212 × 1239 | **RIGID AC** 229 × 1250



Quartet Honey 0870  
DB 184 × 1219 | **SOLID CLIC** 212 × 1239 | **RIGID AC** 229 × 1250



Quartet Fauve 0859  
DB 184 × 1219 | **SOLID CLIC** 212 × 1239 | **RIGID AC** 229 × 1250



Bostonian Oak Honey



# Creation Tiles & planks

## Creation 40

**DB** Creation 40 (Dry Back)    **SOLID CLIC** Creation 40 Solid Clic    **RIGID AC** Creation 40 Rigid Acoustic



Twist 0504  
DB 184 × 1219 | **SOLID CLIC** 212 × 1239 | **RIGID AC** 229 × 1250



Swiss Oak Beige 0848  
DB 184 × 1219 | **SOLID CLIC** 212 × 1239 | **RIGID AC** 229 × 1250



Ranch 0456  
DB 184 × 1219 | **SOLID CLIC** 212 × 1239 | **RIGID AC** 229 × 1250



Amador 0447  
DB 184 × 1219 | **SOLID CLIC** 212 × 1239 | **RIGID AC** 229 × 1250



Salento Beige 1286  
DB 184 × 1219 | **SOLID CLIC** 212 × 1239 | **RIGID AC** 229 × 1250



Cedar Pure 0849  
DB 230 × 1500 | **SOLID CLIC** 240 × 1461 | **RIGID AC** 229 × 1492



White Lime 0584  
DB 184 × 1219 | **SOLID CLIC** 212 × 1239 | **RIGID AC** 229 × 1250



Swiss Oak Pearl 0846  
DB 184 × 1219 | **SOLID CLIC** 212 × 1239 | **RIGID AC** 229 × 1250



Malua Bay 0448  
DB 184 × 1219 | **SOLID CLIC** 212 × 1239 | **RIGID AC** 229 × 1250



Salento Light Grey 1287  
DB 184 × 1219 | **SOLID CLIC** 212 × 1239 | **RIGID AC** 229 × 1250



Swiss Oak Beige



Bostonian Oak Beige 0853  
DB 184 × 1219 | **SOLID CLIC** 212 × 1239 | **RIGID AC** 229 × 1250



Curton Stone Light Beige



# Creation Tiles & planks

## Creation 40

**DB**  
Creation 40 (Dry Back)

**SOLID CLIC**  
Creation 40 Solid Clic

**RIGID AC**  
Creation 40 Rigid Acoustic



Parker Station 0374  
**DB** 610 × 610 | **SOLID CLIC** 389 × 729  
**RIGID AC** 399 × 730



Riverside 0436  
**DB** 610 × 610 | **SOLID CLIC** 389 × 729  
**RIGID AC** 399 × 730

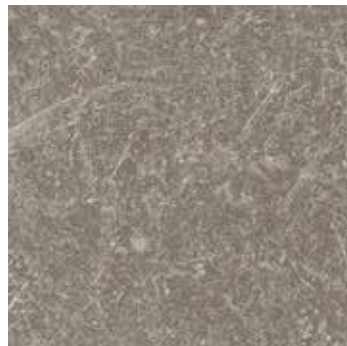

Carmel 0618  
**DB** 457 × 914 | **SOLID CLIC** 389 × 729  
**RIGID AC** 399 × 730



Bloom Uni Taupe 0868  
**DB** 610 × 610 | **SOLID CLIC** 389 × 729  
**RIGID AC** 399 × 730



Curton Stone Light Beige 1276  
**DB** 457 × 914 | **SOLID CLIC** 389 × 729  
**RIGID AC** 399 × 730

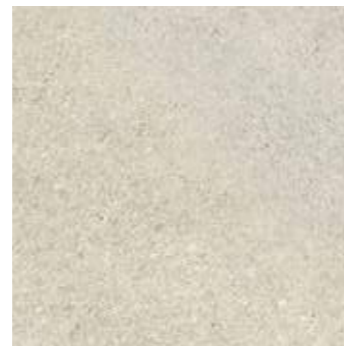

Curton Stone Light Grey 1275  
**DB** 457 × 914 | **SOLID CLIC** 389 × 729  
**RIGID AC** 399 × 730

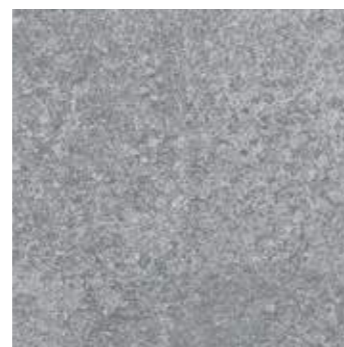

Bloom Uni Grey 0869  
**DB** 610 × 610 | **SOLID CLIC** 389 × 729  
**RIGID AC** 399 × 730









Bloom Uni Grey



# Creation Tiles & planks

## Creation 40

Code	Color Design	Dry Back	Solid Clic	Rigid Acoustic	Skirting Matching Design	Coverstrip Matching Design	Emboss	NCS	LRV
									
0447	Amador	184 × 1219	212 × 1239	229 × 1250	S004	S004	Saw Effect *	5005-Y50R	25.1
0347	Ballerina	184 × 1219	212 × 1239	229 × 1250	S008	S008	Natural	4040-Y20R	28.4
0869	Bloom Uni Grey	610 × 610	389 × 729	399 × 730	S071	S071	Hammered	5005-B20G	23.2
0868	Bloom Uni Taupe	610 × 610	389 × 729	399 × 730	S072	S072	Hammered	4502-Y	28.5
0871	Bostonian Oak	184 × 1219	212 × 1239	229 × 1250	S016	S016	Natural	5020-Y20R	26.4
0853	Bostonian Oak Beige	184 × 1219	212 × 1239	229 × 1250	S017	S017	Natural	4005-Y20R	36.7
0851	Bostonian Oak Honey	184 × 1219	212 × 1239	229 × 1250	S019	S019	Natural	4020-Y20R	29.8
0618	Carmel	457 × 914	389 × 729	399 × 730	S020	S020	Hammered	6005-Y50R	19.2
0850	Cedar Brown	230 × 1500	240 × 1461	229 × 1492	S024	S024	Natural	5020-Y20R	21.3
0849	Cedar Pure	230 × 1500	240 × 1461	229 × 1492	S025	S025	Natural	3010-Y30R	39.8
1276	Curton Stone Light Beige	457 × 914	389 × 729	399 × 730	S184	S184	Stone **	2010-Y40R	48.9
1275	Curton Stone Light Grey	457 × 914	389 × 729	399 × 730	S185	S185	Stone **	3005-Y20R	45.9
0441	Honey Oak	184 × 1219	212 × 1239	229 × 1250	S033	S033	Natural	4020-Y20R	27.7
0455	Long Board	184 × 1219	212 × 1239	229 × 1250	S034	S034	Brushed	4010-Y30R	24.8
0448	Malua Bay	184 × 1219	212 × 1239	229 × 1250	S035	S035	Brushed	2502-Y	47.1
0461	Michigan	184 × 1219	212 × 1239	229 × 1250	S038	S038	Brushed	6020-Y30R	13.5
0374	Parker Station	610 × 610	389 × 729	399 × 730	S047	S047	Hammered	8000-N	12.6
0503	Quartet	184 × 1219	212 × 1239	229 × 1250	S056	S056	Natural	5020-Y20R	19.4
0859	Quartet Fauve	184 × 1219	212 × 1239	229 × 1250	S057	S057	Natural	4030-Y20R	23.9
0870	Quartet Honey	184 × 1219	212 × 1239	229 × 1250	S058	S058	Natural	3040-Y20R	28.2
0456	Ranch	184 × 1219	212 × 1239	229 × 1250	S053	S053	Brushed	5005-Y50R	23.5
0436	Riverside	610 × 610	389 × 729	399 × 730	S032	S032	Hammered	6502-Y	16.7
0445	Rustic Oak	184 × 1219	212 × 1239	229 × 1250	S062	S062	Natural	4030-Y20R	20.4
1286	Salento Beige	184 × 1219	212 × 1239	229 × 1250	S186	S186	Natural	2010-Y40R	37.0
1287	Salento Light Grey	184 × 1219	212 × 1239	229 × 1250	S187	S187	Natural	2005-Y40R	46.6
0848	Swiss Oak Beige	184 × 1219	212 × 1239	229 × 1250	S011	S011	Natural	3010-Y30R	40.1
0796	Swiss Oak Golden	184 × 1219	212 × 1239	229 × 1250	S015	S015	Natural	4030-Y20R	25.8
0846	Swiss Oak Pearl	184 × 1219	212 × 1239	229 × 1250	S014	S014	Natural	3502-Y	36.1
0504	Twist	184 × 1219	212 × 1239	229 × 1250	S039	S039	Natural	3010-Y30R	38.9
0584	White Lime	184 × 1219	212 × 1239	229 × 1250	S074	S074	Saw Effect *	4005-Y20R	36.0

\* Brushed emboss in Rigid Acoustic  
 \*\* Hammered emboss in Rigid Acoustic

### Packaging

Product size (mm)	m <sup>2</sup> /box	m <sup>2</sup> /pallet	Product size (mm)	m <sup>2</sup> /box	m <sup>2</sup> /pallet	Product size (mm)	m <sup>2</sup> /box	m <sup>2</sup> /pallet
<b>Creation 40 Trend</b>			<b>Creation 40 Solid Clic</b>			<b>Creation 40 Rigid Acoustic</b>		
457.2×914.4	4.60	230	212×1238.8	2.10	113.50	229×1250	2	96.4
609.6×609.6	4.83	202.86	239.6×1460.8	2.45	117.60	229×1492	2.39	114.8
184.15×1219.2	4.71	263.76	388.8×728.7	1.98	107.10	399×730	2.04	114.2
230×1500	4.49	255.93						

### Exclusive embosses



Stone



Saw effect



Brushed



Hammered



Natural



# Creation Tiles & planks

## Creation 30

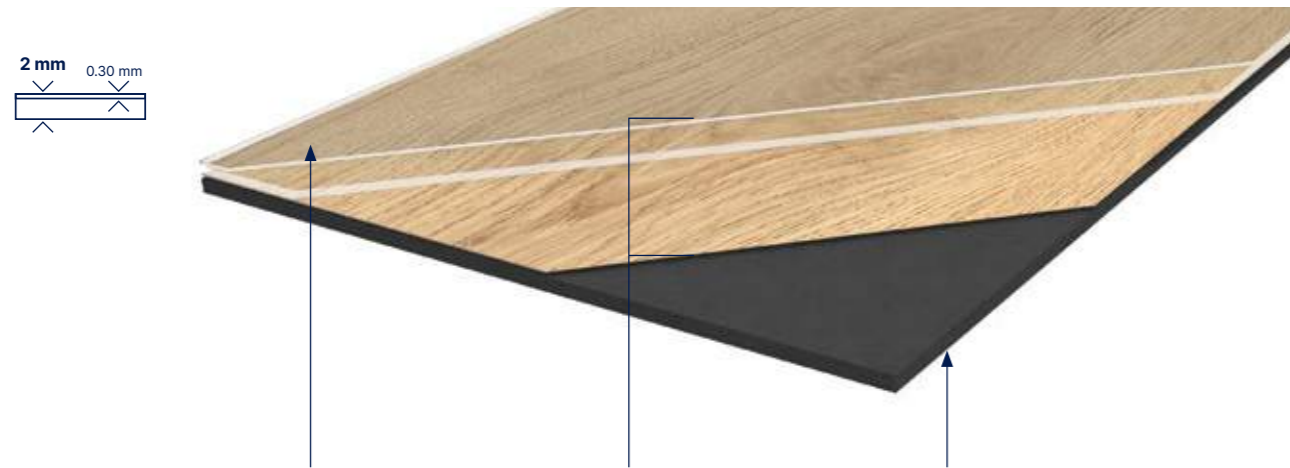

2 mm  
0.30 mm

### PROTECShield™

#### ENHANCED PERFORMANCES

Micro scratch resistance

Easy maintenance

#### ULTRA MATT SURFACE

Natural look

### 4D DESIGN

#### CRYSTAL WEAR LAYER

Authentic Look

#### HIGH DEFINITION PRINTED FILM

Ultra realism

#### STRUCTURED EMBOSS

Ultra realistic surface

#### BEVELLED EDGES

Tiles & Planks effect

### RESILIENT COMFORT CORE



Acoustic comfort



Walking comfort



Easy installation



Easy cutting

## Creation Tiles & planks decoratives strips

Format (mm) 4×914mm



Code: 3203 + Color code



100% Reach Phthalate free



100% Recyclable  
Up to 35% recycled content



TVOC emissions below detection level  
(TVOC < 10µg/m³ after 28 days)  
No formaldehyde

Formats (mm) 184×1219 212×1239 610×610 457×914



Glue down

## Creation 30

**Creation 30 Design** is a synthetic, decorative, flexible, antistatic abrasion group T floorcoverings available in tile or plank, with bevelled edges. It consists in a 0,3 mm thick transparent wear layer, a design film and a Resilient Comfort Core to provide softness and comfort surface. The overall thickness is 2 mm. They benefit from a cross-linked polyurethane surface treatment (**ProtecShield™**), making maintenance easier and prevent from micro scratches.

**Creation 30 Design** is a glued floorcovering, resistant to

Can be combined with pre-adhesive underlayer

Gerflor Smart Fix 16 dB



Code: 1698 - Format: 1m x 7.5ml



use (residential / commercial use) of 23 / 31 according to EN-ISO 10874 and has Bfl -s1 class for smoke emission according to EN 13501-1.

**Creation 30 Design** is made with phthalate free plasticizers, except recycled content. It is 100% recyclable and made with 35% of recycled content. It is 100% compliant with REACH.

**The product emission rate of organic compounds is < 10 microgram/m³ (TVOC < 28 days - ISO 16000-6).**

### Creation 30

#### Creation 30 Design

#### Description

Total thickness	EN ISO 24346	mm	2
Thickness of wearlayer	EN ISO 24340	mm	0.30
Weight	EN ISO 23997	g/sqm	3 460
Size	EN ISO 24342	mm	Planks - 184 × 1219 / 230×1500 Tiles - 457×914 / 610×610
Number of planks / tiles and sqm per box	-	-	15-11-9-9 / 3.36-3.80-3.76-3.35

#### Classification

Norm / Product specification	-	-	EN ISO 10582
European classification	EN ISO 10874	class	23 - 31
Fire rating	EN 13501-1	class	Bfl-s1
Static electrical propensity	EN 1815	kV	< 2
Slip resistance wet: ramp test with oil	EN 16165:2021 - Appendix B (DIN 51 130)	class	R10

#### Performances

Wear resistance	EN 660.2	mm³	≤ 2.0
Wear group	-	group	T
Type Binder content	ISO 10582	type	I
Room impact	NF S 31074	dB	77
Impact sound insulation	EN ISO 717-2	dB	4
Dimensional stability (norm)	EN ISO 23999	%	≤ 0.25
Dimensional stability (average measured value)	-	%	≤ 0.10
Residual indentation	EN ISO 24343-1	mm	≤ 0.10
Castor chair test (type H)	ISO 4918	-	OK
Thermal conductivity	EN ISO 10456	W/(m.k)	0.25
Colour fastness	EN ISO 105-B02	degree	≥ 6
Surface treatment	-	-	ProtecShield™
Chemical products resistance	EN ISO 26987	-	OK

#### Environment / indoor air quality

TVOC after 28 days	ISO 16000-6	microgram/m³	< 10
Certification	-	-	Floorscore®

#### CE marking



EN 14041





# Creation Tiles & planks

## Creation 30 Solid Clic



### PROTECSHIELD™

#### ENHANCED PERFORMANCES



Micro scratch resistance



Easy maintenance

#### ULTRA MATT SURFACE



Natural look

### 4D DESIGN

#### CRYSTAL WEAR LAYER



Authentic Look

#### HIGH DEFINITION PRINTED FILM



Ultra realism

#### STRUCTURED EMBOSS



Ultra realistic surface

#### BEVELLED EDGES



Tiles & Planks effect

### DUOCORE 2.0 TECHNOLOGY

#### RESILIENT COMFORT CORE



Acoustic comfort



Walking comfort

#### NEW RIGID CORE



Renovation over ceramic tiles 6mm/2mm



Resistance against high temperature variation

#### CUTTING



Easy cutting

### EXCLUSIVE INTERLOCKING SYSTEM

#### ANGULAR ON LONG SIDE



Quiet installation

#### VERTICAL ON SHORT SIDE



Traffic resistance Durability



Fast & easy to install



Waterproof Joints



100% Reach Phthalate free



100% Recyclable Up to 55% recycled content



TVOC emissions below detection level (TVOC < 10µg/m³ after 28 days) No formaldehyde

Formats (mm)

212x1238

240x1461

389x729



## Creation 30 Solid Clic

**Creation 30 Solid Clic** is a decorative, flexible, abrasion group T floorcoverings available in tiles and planks, with bevelled edges. It consists in a 0,3 mm thick transparent wear layer, a design film of 2 m width printed in high definition to have more variety in the design and the technology "Duo Core 2.0": combination of a rigid core back layer for easy renovation and a flexible core top layer to provide softness and comfort surface, the whole with a double reinforcement for enhanced durability. The overall thickness is 4,5 mm. They benefit from a cross-linked polyurethane surface treatment (**Protecshield™**), making maintenance easier and avoiding microscratches.

**Creation 30 Solid Clic** is an interlocking floorcovering assembled with a vertical system on the short side and a horizontal system on long side for a quick and solid installation. It has a European class (residential / commercial use) 23/31 according to EN-ISO 10874 and has Bfl-s1 class for smoke emission according to EN 13501-1. **Creation 30 Solid Clic** is made with phthalate free plasticizers (except recycled content). It is 100% recyclable and made with a recycled content up to 55%. It is 100% compliant with REACH. **The product emission rate of organic compounds is < 10 microgram/m³ (TVOC < 28 days – ISO 16000-6).**

## To be combined with Gerflor acoustic underlayers

Gerflor Acoustic 15 dB



Code: 1798 - Format: 1m x 15ml

Gerflor Acoustic Plus 19 dB



Code: 0704 - Format: 0.98m x 15.3ml

Gerflor Silence Plus 19 dB



Code: 5949 - Format: 1.18m x 8.5ml

Please refer to Gerflor's installation guidelines.

### Creation 30 Solid Clic

#### Description

Total thickness	EN ISO 24346	mm	4.50
Thickness of wearlayer	EN ISO 24340	mm	0.30
Weight	EN ISO 23997	g/sqm	7118
Size	EN ISO 24342	mm	Planks - 212x1238,8 / 240 x 1461 Tiles - 389 x 729
Number of planks / tiles and sqm per box	EN ISO 24342	mm	8-7-7/ 2,10-2,45-1,98

#### Classification

Norm / Product specification	-	-	EN ISO 10582
European classification	EN ISO 10874	class	23 - 31
Fire rating	EN 13501-1	class	Bfl-s1
Static electrical propensity	EN 1815	kV	< 2
Slip resistance wet: ramp test with oil	EN 16165:2021 - Appendix B (DIN 51 130)	class	R10

#### Performances

Wear resistance	EN 660.2	mm³	< 2.0
Wear group	-	group	T
Type Binder content	ISO 10582	type	I
Room impact	NF S 31074	dB	79
Impact sound insulation	EN ISO 717-2	dB	4
Dimensional stability (norm)	EN ISO 23999	%	≤ 0.15
Dimensional stability (average measured value)	-	%	≈ 0.05
Residual indentation	EN ISO 24343-1	mm	≤ 0.10
Castor chair test (type H)	ISO 4918	-	OK
Thermal conductivity	EN ISO 10456	W/(m.k)	0.25
Colour fastness	EN ISO 105-B02	degree	≥ 6
Surface treatment	-	-	ProtecShield™
Chemical products resistance	EN 423	-	OK

#### Environment / indoor air quality

TVOC after 28 days	ISO 16000-6	microgram/m³	< 10
Certification	-	-	Floorscore®

#### CE Marking



EN 14041





# Creation Tiles & planks

## Creation 30

**DB** Creation 30 (Dry Back)    **SOLID CLIC** Creation 30 Solid Clic



Brownie 0459  
DB 184 × 1219



Bostonian Oak 0871  
DB 184 × 1219 | **SOLID CLIC** 212 × 1239



Cedar Brown 0851  
DB 230 × 1500 | **SOLID CLIC** 240 × 1461



Oak Fantasy Honey 1296  
DB 184 × 1219 | **SOLID CLIC** 212 × 1239



Oak Fantasy Brown 1294  
DB 184 × 1219 | **SOLID CLIC** 212 × 1239



Oak Fantasy Grey 1295  
DB 184 × 1219 | **SOLID CLIC** 212 × 1239



Bostonian Oak Honey 0851  
DB 184 × 1219 | **SOLID CLIC** 212 × 1239



Quartet Honey 0870  
DB 184 × 1219 | **SOLID CLIC** 212 × 1239



Michigan 0461  
DB 184 × 1219 | **SOLID CLIC** 212 × 1239



Amarante 0579  
DB 184 × 1219



Ballerina 0347  
DB 184 × 1219 | **SOLID CLIC** 212 × 1239



Quartet Fauve 0859  
DB 184 × 1219 | **SOLID CLIC** 212 × 1239



Quartet 0503  
DB 184 × 1219 | **SOLID CLIC** 212 × 1239



Buffalo 0457  
DB 184 × 1219



White Lead Oak Dark Beige 1289  
DB 184 × 1219



Swiss Oak Golden 0796  
DB 184 × 1219 | **SOLID CLIC** 212 × 1239



# Creation Tiles & planks

## Creation 30

**DB**  
Creation 30 (Dry Back)

**SOLID CLIC**  
Creation 30 Solid Clic



Honey Oak 0441  
DB 184 × 1219 | **SOLID CLIC** 212 × 1239



Cedar Pure 0849  
DB 184 × 1219 | **SOLID CLIC** 240 × 1239



Twist 0504  
DB 184 × 1219 | **SOLID CLIC** 212 × 1239

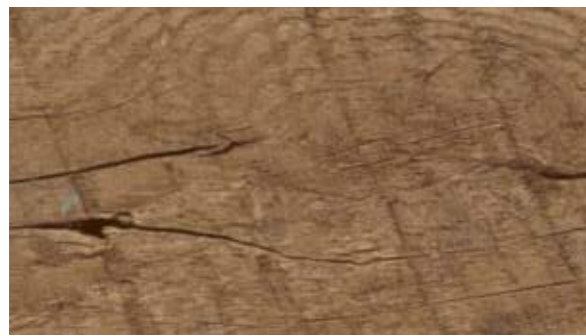

Rustic Oak 0445  
DB 184 × 1219 | **SOLID CLIC** 212 × 1239



Cambridge 0465  
DB 184 × 1219



Northwood Mokaccino 0817  
DB 184 × 1219



Long Board 0455  
DB 184 × 1219 | **SOLID CLIC** 212 × 1239



White Lead Oak Blond 1288  
DB 184 × 1219



Salento Light Grey 1287  
DB 184 × 1219 | **SOLID CLIC** 212 × 1239



Braukerne Natural 1292  
DB 184 × 1219 | **SOLID CLIC** 212 × 1239



Braukerne Beige 1293  
DB 184 × 1219 | **SOLID CLIC** 212 × 1239



Salento Beige 1286  
DB 184 × 1219 | **SOLID CLIC** 212 × 1239



Salento Light Grey

Creation  
Tiles & planks



# Creation Tiles & planks

## Creation 30

**DB** Creation 30 (Dry Back)    **SOLID CLIC** Creation 30 Solid Clic



Chevron Hurricane 0809  
DB 184 x 1219



Oxford 0061  
DB 184 x 1219



Swiss Oak Beige 0848  
DB 184 x 1219 | **SOLID CLIC** 212 x 1239



Malua Bay 0448  
DB 184 x 1219 | **SOLID CLIC** 212 x 1239



Bostonian Oak Grey 0855  
DB 184 x 1219



Amador 0447  
DB 184 x 1219 | **SOLID CLIC** 212 x 1239



Arena 0060  
DB 184 x 1219



Bostonian Oak Beige 0853  
DB 184 x 1219 | **SOLID CLIC** 212 x 1239



Ranch 0456  
DB 184 x 1219 / 230x1500 | **SOLID CLIC** 212 x 1239



Paint Wood Taupe 0856  
DB 184 x 1219



Swiss Oak Pearl 0846  
DB 184 x 1219 | **SOLID CLIC** 212 x 1239



White Lime 0584  
DB 184 x 1219 | **SOLID CLIC** 212 x 1239



White Lead Oak Shadow Grey 1290  
DB 184 x 1219



Swiss Oak Cashmere 0795  
DB 184 x 1219



Stripe Oak Ice 0858  
DB 184 x 1219



Northwood Macchiato 0816  
DB 184 x 1219



# Creation Tiles & planks

## Creation 30



Durango Taupe 0751  
DB 610 x 610



Curton Stone Light Grey 1275  
DB 457 x 914  
SOLID CLIC 389 x 729



Durango Moka 0750  
DB 610 x 610



Curton Stone Light Beige 1276  
DB 457 x 914  
SOLID CLIC 389 x 729



Bloom Uni Taupe 0868  
DB 610 x 610  
SOLID CLIC 389 x 729



Reggia Ivory 0861  
DB 457 x 914



Back Street 0748  
DB 457 x 914



Urban Street Beige 1285  
DB 610 x 610



Curton Stone Light Beige



Oppland Stone

DB  
Creation 30 (Dry Back)

SOLID CLIC  
Creation 30 Solid Clic



Oppland Stone 1291  
DB 457 x 914



Parker Station 0374  
DB 610 x 610  
SOLID CLIC 389 x 729



Riverside 0436  
DB 610 x 610  
SOLID CLIC 389 x 729



Silver City 0373  
DB 610 x 610



Urban Street Medium 1284  
DB 610 x 610

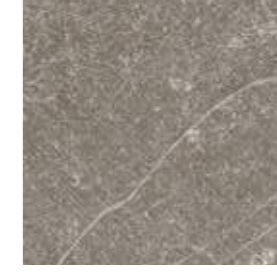

Carmel 0618  
DB 457 x 914  
SOLID CLIC 389 x 729



Bloom Uni Grey 0869  
DB 610 x 610  
SOLID CLIC 389 x 729









Urban Street Light 1283  
DB 610 x 610



# Creation Tiles & planks

## Creation 30

Code	Color Design	Dry Back	Solid Clic	Skirting Matching design	Coverstrip Matching design	Emboss	NCS	LRV
								
0447	Amador	184 × 1219	212 × 1239	S004	S004	Saw Effect	5005-Y50R	25.1
0579	Amarante	184 × 1219	-	S005	S001	Brushed	5010-Y30R	21.3
0060	Arena	184 × 1219	-	S026	S001	Saw Effect	4005-Y20R	37.2
0748	Back Street	457 × 914	-	S095	S001	Hammered	4502-Y	27.9
0347	Ballerina	184 × 1219	212 × 1239	S008	S008	Natural	4040-Y20R	28.4
0869	Bloom Uni Grey	610 × 610	389 × 729	S071	S071	Hammered	5005-B20G	23.2
0868	Bloom Uni Taupe	610 × 610	389 × 729	S072	S072	Hammered	4502-Y	28.5
0871	Bostonian Oak	184 × 1219	212 × 1239	S016	S016	Natural	5020-Y20R	26.4
0853	Bostonian Oak Beige	184 × 1219	212 × 1239	S017	S017	Natural	4005-Y20R	36.7
0855	Bostonian Oak Grey	184 × 1219	-	S018	S001	Natural	6005-Y20R	24.0
0851	Bostonian Oak Honey	184 × 1219	212 × 1239	S019	S019	Natural	4020-Y20R	29.8
1293	Braukerne Beige	184 × 1219	212 × 1239	S158	S001	Brushed	3010-Y40R	35.8
1292	Braukerne Natural	184 × 1219	212 × 1239	S159	S001	Brushed	3020-Y60R	29.3
0459	Brownie	184 × 1219	-	S073	S001	Natural	6020-Y30R	10.7
0457	Buffalo	184 × 1219	-	S075	S001	Brushed	6010-Y10R	16.3
0465	Cambridge	184 × 1219	-	S065	S001	Natural	3030-Y20R	39.8
0618	Carmel	457 × 914	389 × 729	S020	S020	Hammered	6005-Y50R	19.2
0850	Cedar Brown	230 × 1500	240 × 1461	S024	S024	Natural	5020-Y20R	21.3
0849	Cedar Pure	230 × 1500	240 × 1461	S025	S025	Natural	3010-Y30R	39.8
0809	Chevron Hurricane	184 × 1219	-	S030	S001	Natural	6502-Y	13.8
1276	Curton Stone Light Beige	457 × 914	389 × 729	S184	S184	Stone	2010-Y40R	48.9
1275	Curton Stone Light Grey	457 × 914	389 × 729	S185	S185	Stone	3005-Y20R	45.9
0750	Durango Moka	610 × 610	-	S164	S001	Hammered	6005-Y50R	20.5
0751	Durango Taupe	610 × 610	-	S093	S001	Hammered	3005-Y20R	37.7
0441	Honey Oak	184 × 1219	212 × 1239	S033	S033	Natural	4020-Y20R	27.7
0455	Long Board	184 × 1219	212 × 1239	S034	S034	Brushed	4010-Y30R	24.8
0448	Malua Bay	184 × 1219	212 × 1239	S035	S035	Brushed	2502-Y	47.1
0461	Michigan	184 × 1219	212 × 1239	S038	S038	Brushed	6020-Y30R	13.5
0816	Northwood Macchiato	184 × 1219	-	S040	S001	Brushed	1502-Y50R	67.8
0817	Northwood Mokaccino	184 × 1219	-	S041	S001	Brushed	3010-Y30R	39.3
1294	Oak Fantasy Brown	184 × 1219	212 × 1239	S172	S001	Brushed	7010-Y90R	8.7
1295	Oak Fantasy Grey	184 × 1219	212 × 1239	S173	S001	Brushed	6010-Y70R	11.4
1296	Oak Fantasy Honey	184 × 1219	212 × 1239	S174	S001	Brushed	5020-Y50R	19.5
1291	Oppland Stone	457 × 914	-	S175	S001	Hammered	7500-N	7.7
0061	Oxford	184 × 1219	-	S043	S001	Brushed	5502-Y	19.2
0856	Paint Wood Taupe	184 × 1219	-	S046	S001	Brushed	5502-Y	18.9
0374	Parker Station	610 × 610	389 × 729	S047	S047	Hammered	8000-N	12.6
0503	Quartet	184 × 1219	212 × 1239	S056	S056	Natural	5020-Y20R	19.4
0859	Quartet Fauve	184 × 1219	212 × 1239	S057	S057	Natural	4030-Y20R	23.9
0870	Quartet Honey	184 × 1219	212 × 1239	S058	S058	Natural	3040-Y20R	28.2
0456	Ranch	184 × 1219	212 × 1239	S053	S053	Brushed	5005-Y50R	23.5
0861	Reggia Ivory	230 × 1500	-	S054	S001	Stone	3010-Y20R	46.1
0436	Riverside	457 × 914	389 × 729	S032	S032	Hammered	6502-Y	16.7
0445	Rustic Oak	610 × 610	212 × 1239	S062	S062	Natural	4030-Y20R	20.4
1286	Salento Beige	184 × 1219	212 × 1239	S186	S186	Natural	2010-Y40R	37.0
1287	Salento Light Grey	184 × 1219	212 × 1239	S187	S187	Natural	2005-Y40R	46.6
0373	Silver City	184 × 1219	-	S048	S001	Hammered	6502-Y	19.1
0858	Stripe Oak Ice	610 × 610	-	S009	S001	Natural	3502-Y	37.3
0848	Swiss Oak Beige	184 × 1219	212 × 1239	S011	S011	Natural	3010-Y30R	40.1
0795	Swiss Oak Cashmere	184 × 1219	-	S012	S001	Natural	4010-Y30R	33.3
0796	Swiss Oak Golden	184 × 1219	212 × 1239	S015	S015	Natural	4030-Y20R	25.8
0846	Swiss Oak Pearl	184 × 1219	212 × 1239	S014	S014	Natural	3502-Y	36.1
0504	Twist	184 × 1219	212 × 1239	S039	S039	Natural	3010-Y30R	38.9
1285	Urban Street Beige	184 × 1219	-	S178	S001	Hammered	4005-Y50R	31.2
1283	Urban Street Light	610 × 610	-	S094	S001	Hammered	3502-R	42.3
1284	Urban Street Medium	610 × 610	-	S180	S001	Hammered	4502-R	26.5
1288	White Lead Oak Blond	610 × 610	-	S181	S001	Brushed	3010-Y40R	29.6
1289	White Lead Oak Dark Beige	184 × 1219	-	S182	S001	Brushed	5010-Y10R	25.3
1290	White Lead Oak Shadow Grey	184 × 1219	-	S183	S001	Brushed	3502-Y	34.6
0584	White Lime	184 × 1219	212 × 1239	S074	S074	Saw Effect	4005-Y20R	36.0

S001:  
White      S001:  
Aluminium

### Packaging

Product size (mm)	m <sup>2</sup> /box	m <sup>2</sup> /pallet	Product size (mm)	m <sup>2</sup> /box	m <sup>2</sup> /pallet
<b>Creation 30 Design</b>			<b>Creation 30 Solid Clic</b>		
457 × 914	3.76	248.16	212 × 1239	2.10	113.50
610 × 610	3.35	234.50	240 × 1461	2.45	117.60
184 × 1219	3.36	241.92	389 × 729	1.98	107.10
230×1500	3.80	250.80			
Chevron 184 × 1219	3.14	251.20			

### Exclusive embosses



Stone



Saw effect



Brushed



Hammered



Natural



# Creation Tiles & planks

My Creation / My Saga<sup>2</sup>

## Beyond the norm

As you are unique and each of your projects represents a new challenge, Gerflor gives you the chance to stand out, from 200 sqm.

One atmosphere, one style, one floor, but several possibilities...

My Creation \_\_\_\_\_

**Available installations :**  
My Creation 70 Glue Down  
My Creation 55 Glue Down

**Available formats :**  
Lame 208 × 1243 mm  
Dalle 496,5 × 996,5 mm



My Saga<sup>2</sup> \_\_\_\_\_

**Available formats :**  
Dalle 500 × 500 mm



New My Creation and My Saga<sup>2</sup> collections are available on [gerflor.com](http://gerflor.com)

Do not hesitate to contact your sales representative



## 3 Possibilities



### 1 - Colour

Set the tone of your project by recolouring the design of your choice in our Creation or Saga<sup>2</sup> ranges



### 2 - Collection

Leave a big impression on the atmosphere that you create thanks to our unique collection of 50 designs that reflect the major decorative trends that are popular today.  
All of our customisable designs: [myfloorbygerflor.com](http://myfloorbygerflor.com)



### 3 - Customisation

Enhance the visual identity of your company or that of your clients by printing a logo and/or your own designs.



**My Creation, My Saga<sup>2</sup>**  
Let's bring your inspiration to life together!





# Creation Tiles & planks

More than a floor...

## Underlayer

### Creation Solid Clic

Gerflor Acoustic 15 dB 



Code: 1798  
Format: 1m x 15ml

Gerflor Acoustic Plus 19 dB 



Code: 0704  
Format: 0.98m x 15.3ml

Gerflor Silence Plus 19 dB 



Code: 5949  
Format: 1.18m x 8.5ml

### Creation (Dry Back)\*

Gerflor Smart Fix 16 dB 



Code: 1698  
Format: 1m x 7.5ml

## Design skirting



Vinyl Code: 6086 + Color code / MDF Code: 5947 + Color code

## Design coverstrip



Code: 0647 + Color code - Format: 45mm x 0.90m  
Available colors on gerflor.com

### 3 usages



## Entrance mat

Quickmat Tiles: Pre-adhesed planks (12mm thick)

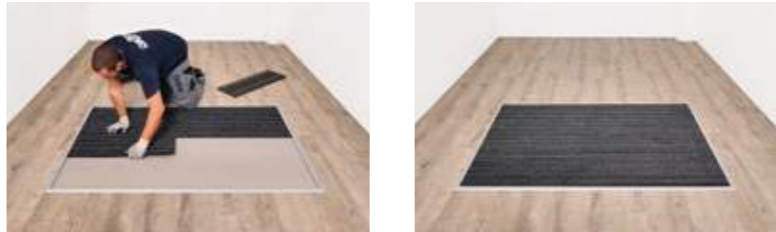

Code: 1725, profiles 1726 and angles 1727 - Adapted to 4 to 6mm thick products

## Tools



Anti-bounce mallet: 5951

\* Except Creation 70



# Carpet Tiles

pages 228-239

232. **Armonia 400** New

236. **Armonia 520** New

238. **Armonia 620** New





# Armonia 400 New

## Armonia 400 - 100% Polypropylene

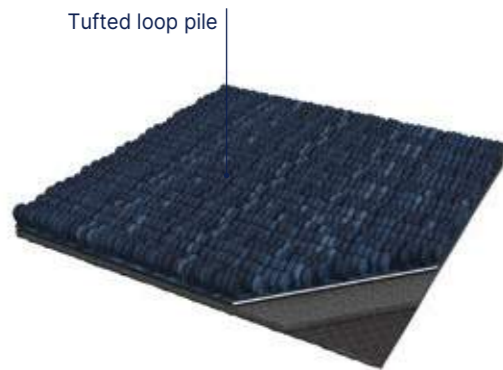

**Armonia 400** is a decorative, reliable, hardwearing textile floor covering. It consists in a tufted 50 × 50 cm loop pile carpet tile with a 2,3 mm pile height. The overall thickness is 5,3 mm with 400 pile weight.

**Armonia 400** is a 100% Polypropylene solution carpet tile with Bfl-s1 free floating on cement class for smoke emission according to EN 13501-1.

**Armonia 400** is REACH compliant. The product emission rate of organic compounds is < 100 micrograms/m<sup>3</sup> (TVOC < 28 days – EN 16516).

**B-connect** is a glue-free installation solution for Armonia tiles. The self-adhesive connectors are repositionable. They do not leave any marks on the back of the tile and keep the substrate clean. This solution promotes the recycling of tiles and simplifies the installation of a new covering on the preserved substrate.

The B-connect connectors are pre-cut and delivered in rolls of 200 connectors, covering approximately 50m<sup>2</sup> of Armonia tiles.



- **Easy mix with Gerflor collections** (Creation & Saga<sup>2</sup>)
- **Tile format** 500×500 mm
- **Light commercial use**

- **Indoor Air Quality** TVOC <100µg/m<sup>3</sup> (ISO 16516 - after 28 days)
- **Installation** Monolithic or quarter-turn
- **Adhesive free possible** with connectors (B connect)

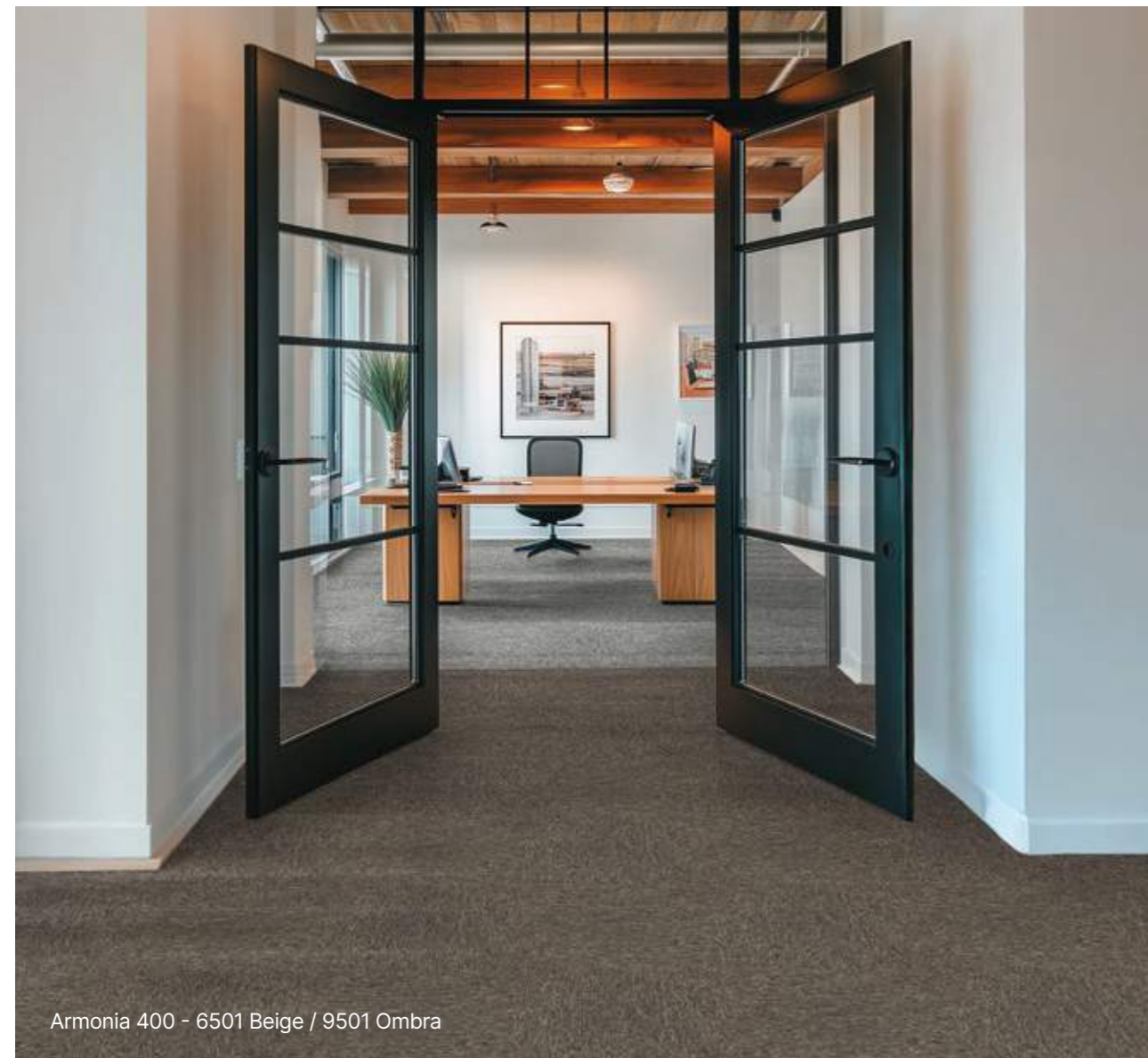

### Armonia 400

Description			
Nature	ISO 2424	-	Loose-laid carpet tile
Construction	ISO 2424	-	Tufted loop pile
Pile Material	-	-	100% Polypropylene
Backing	ISO 2424	-	Bitumen
Gauge	ISO 1763	-	1/10
Pile Weight	ISO 2424	g/m <sup>2</sup>	400
Surface Pile Weight	ISO 2424	g/m <sup>2</sup>	240
Stitch Density	ISO 1763	tufts/m <sup>2</sup>	145 800
Total Weight	ISO 8543	g/m <sup>2</sup>	3790
Total Thickness	ISO 1765	mm	5.3
Pile Height	ISO 1766	mm	2.3
Size	ISO 24342	cm	50 × 50
Classification			
European Classification	EN 1307	class	31
Fire Rating	EN 13 501-1	class	Bfl-s1 affixed on cement
Static Electrical Propensity	ISO 6536	kV	≤2
Luxury Rating	EN 1307	class	LC1
Slip resistance	EN 13893	µ	≥0.3
Performances			
Dimensional Stability	EN 986	%	≤0.2
Thermal Resistance	ISO 8302	m <sup>2</sup> C°/W	≤0,09 (0,0578)
Color Fastness	EN ISO 105 - B02	degree	≥6
Environment/Indoor air quality			
TVOC after 28 days	EN 16516	micrograms/m <sup>3</sup>	≤100
Label GuT	n° GUT - Prodís		BFACFED8
CE Marking			
CE	EN 14041	-	

Packaging		
Tiles per Box	unit	24
Tiles per Box	m <sup>2</sup>	6
Weight per Box	kg	22,96
Box per Pallet	unit	24
Pallet	m <sup>2</sup>	144



# Armonia 400 New

 **Comfort**  
500 x 500 mm

 **100% recyclable**



6501 Beige

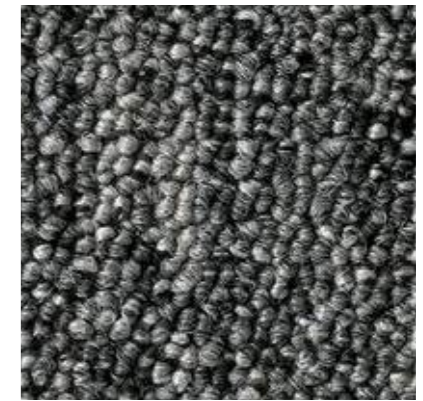

9501 Ombra

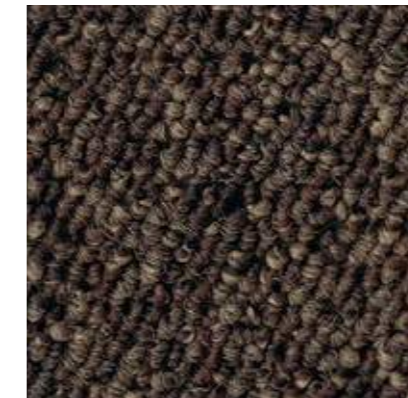

7801 Cacao



9701 Titanio



1801 Indigo



9901 Oxford

Scale 1

Creation 55 Looselay - 1559 Tamo Light / Armonia 400 - 7801 Cacao



# Armonia 520 & 620 New

## Armonia 520 - Nylon - 520g/m<sup>2</sup>

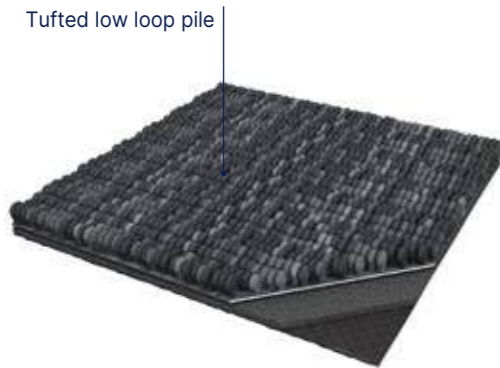

Tufted low loop pile

**Armonia 520** is a decorative, reliable, hardwearing textile floor covering. It consists in a tufted 50 × 50 cm low loop pile carpet tile with a 2,5 mm pile height. The overall thickness is 5,6 mm with a 520 g/m<sup>2</sup> pile weight.

**Armonia 520** is a 100% Nylon piece dyed carpet tile with resistance to use (commercial) of 33 according to EN 1307 and has Bfl-s1 free floating on cement class for smoke emission according to EN 13501-1.

**Armonia 520** has an impact sound insulation of 22 dB according to the EN ISO 10140 and a noise reduction of 0.15 αω ISO 11654.

**Armonia 520** is REACH compliant. The product emission rate of organic compounds is < 100 micrograms/m<sup>3</sup> (TVOC < 28 days - EN 16516).

## Armonia 620 - Econyl 100% recycled - 620g/m<sup>2</sup>

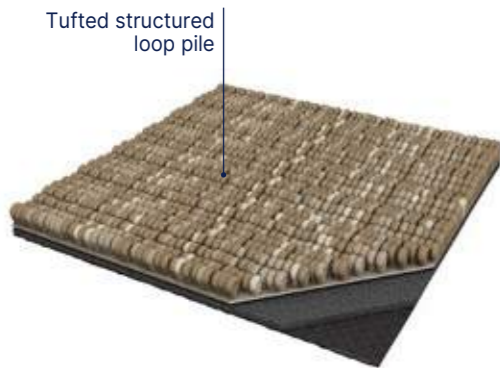

Tufted structured loop pile

**Armonia 620** is a decorative, reliable, hardwearing textile floor covering. It consists in a tufted 50 × 50 cm structured loop pile carpet tile with a 3,2 mm pile height. The overall thickness is 6,5 mm with 620 pile weight.

**Armonia 620** is a 100% Nylon solution dyed carpet tile with resistance to use (commercial) of 33 according to EN 1307 and has Bfl-s1 free floating on cement class for smoke emission according to EN 13501-1.

**Armonia 620** has an impact sound insulation of 24 dB according to the EN ISO 10140 and a noise reduction of 0.20 αω according to the ISO 11654.

**Armonia 620** contents 15% of recycled content. It is REACH compliant. The product emission rate of organic compounds is < 100 micrograms/m<sup>3</sup> (TVOC < 28 days - EN 16516).

**B-connect** is a glue-free installation solution for Armonia tiles. The self-adhesive connectors are repositionable. They do not leave any marks on the back of the tile and keep the substrate clean. This solution promotes the recycling of tiles and simplifies the installation of a new covering on the preserved substrate.

The B-connect connectors are pre-cut and delivered in rolls of 200 connectors, covering approximately 50m<sup>2</sup> of Armonia tiles.



Armonia 620 - 6103 Polvere



- For intensive commercial use
- Specific colours for perfect mix with Gerflor collections (Creation & Saga<sup>2</sup>)
- Tile format: 500×500 mm
- TVOC <100µg/m<sup>3</sup> ⇒ indoor air quality (ISO 16516 - after 28 days)

- Installation monolithic or quarter-turn
- Adhesive free possible with connectors (B connect)
- Third part certified EPD

	Armonia 520		Armonia 620	
<b>Description</b>				
Nature	ISO 2424	-	Loose-laid carpet tile	Loose-laid carpet tile
Construction	ISO 2424	-	Tufted low loop pile	Tufted structured loop pile
Pile Material	-	-	100% Polyamide	100% Polyamide Econyl®
Backing	ISO 2424	-	Bitumen	Bitumen
Gauge	ISO 1763	-	1/10	1/10
Pile Weight	ISO 2424	g/m <sup>2</sup>	520	620
Surface Pile Weight	ISO 2424	g/m <sup>2</sup>	280	420
Stitch Density	ISO 1763	tufts/m <sup>2</sup>	142 200	173 800
Total Weight	ISO 8543	g/m <sup>2</sup>	4000	4105
Total Thickness	ISO 1765	mm	5.6	6.5
Pile Height	ISO 1766	mm	2.4	3.2
Size	ISO 24342	cm	50 × 50	50 × 50
<b>Classification</b>				
European Classification	EN 1307	class	33	33
Fire Rating	EN 13 501-1	class	Bfl-s1	Bfl-s1
Static Electrical Propensity	ISO 6536	kV	≤2	≤2
Luxury Rating	EN 1307	class	LC1	LC2
Slip resistance	EN 13893	μ	≥0.3	≥0.3
<b>Performances</b>				
Noise reduction	ISO 11654	αω	0.15	0.20
Impact Sound Insulation	ISO 140-8	dB	22	24
Dimensional Stability	EN 986	%	≤0.2	≤0.2
Castor Chair Test (type H)	ISO 4918	-	≥2.4	≥2.4 (Class A)
Thermal Resistance	ISO 8302	m <sup>2</sup> C°/W	< 0.09 (0,0659)	<0.09 (0,0726)
Color Fastness	EN ISO 105 - B02	degree	>5-6/8	>7/8
<b>Environment/Indoor air quality</b>				
TVOC after 28 days	EN 16516	micrograms/m <sup>3</sup>	≤100	≤100
Label GuT	n° GUT - Prodis		7FDF1AC0	BAEA3BAE
<b>CE Marking</b>				
CE	EN 14041	-		

Packaging	Armonia 520	Armonia 620
Tiles per Box	unit 24	20
Tiles per Box	m <sup>2</sup> 6	5
Weight per Box	kg 24,34	20,89
Box per Pallet	unit 20	20
Pallet	m <sup>2</sup> 120	100



# Armonia 520 **New**



9902 Nero



1702 Blu



9302 Cielo



9702 Grigio



9502 Denim



9102 Argento



Armonia 520 - 9102 Argento



6152 Corda



5502 Mattone



2702 Giungla



7202 Tortora



4302 Terracotta



2402 Foresta



3202 Ocra



7402 Greige



# Armonia 620 New



Creation 70 Looselay - 1576 Stony Medium / Armonia 620 - 6103 Polvere



6103 Polvere



9203 Nuvola



6273 Argilla



2173 Salvia



9303 Piombo



9503 Antracite

Scale 1





Revela tiles



Revela panels

## Wall Solutions

pages 240-255

### 242. Wall panels & tiles

- 242. Mural Revela **New**
- 248. Mural Revela accessories **New**

### 250. Wall coverings

- 252. Mural Ultra Design
- 254. Mural Club
- Mural Calypso **New**
- (See page 296)



# Wall panels & tiles

## Mural Revela New

### Mural Revela

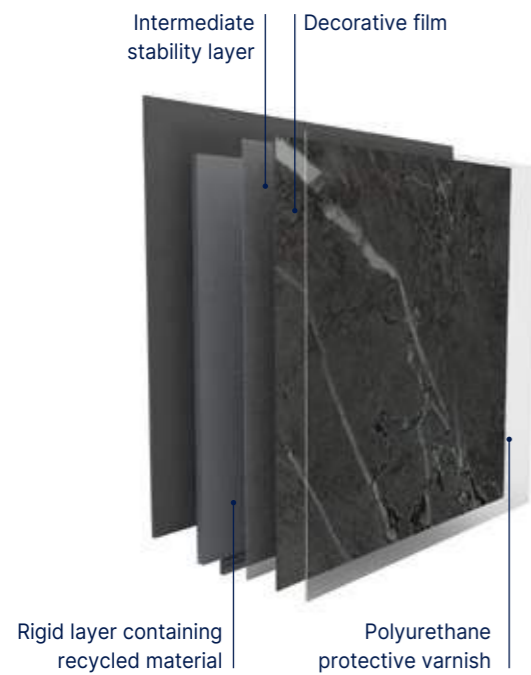

**MURAL REVELA** is a rigid vinyl wall covering which has a thickness of 5mm for an extended durability. It is available in 2 formats of 65 × 37,5cm for tiles or 260 × 90cm / 260 × 120cm for panels. It is intended for indoor use.

Its non-porous conception, its tongue and groove assembly system combined with a glued installation give **MURAL REVELA** a water resistance allowing an installation in wet areas including showers. Thanks to its robust conception and the total thickness of the product, **MURAL REVELA** is an ideal solution for renovation on ceramic tiles.

It has a fire reaction classification D-s3,d0 according to EN13501. It has excellent chemical resistance according to EN 423. It will be CMR 1 & 2 free and 100% Reach compliant. TVOC 28-day air emissions (NF EN 16000-6) will be classified as A+ (best class) under French health labelling.

**MURAL REVELA** has been designed and is produced in Europe. **MURAL REVELA** contains up to 30% recycled and is 100% recyclable. It can be collected and recycled through the Gerflor Second Life programme (selected countries).



- Tile and XL/XXL panel sizes
- Groove/tongue assembly
- Suitable for new builds
- Refurbishment over existing ceramic tiles
- Easy and quick to install
- Water resistant
- Washable product
- Installation in shower and/or bathtub area

Mural Revela			
	Tile	XL Panel	XXL Panel
<b>Description</b>			
Total thickness	EN ISO 24346	mm	5
Weight	EN ISO 23997	g/sqm	Matt : 6750 / Gloss : 7500
Size	NF EN ISO 24341	cm	65 × 37,5      90 × 260      120 × 260
Chanfrein	-	-	Oui      Non      Non
<b>Classification</b>			
Product specification	-	-	EN 15 102
Fire rating	EN 13501-1	class	D-s3,d0
<b>Performances</b>			
Surface Treatment	-	-	OK
Cleanability	EN 233	-	Washable and brushable
<b>Environment/Indoor Air Quality</b>			
TVOC after 28 days	ISO 16516	µg/ m <sup>3</sup>	<100
Recyclability	-	-	100%
Recycled content	-	-	Up to 30%
<b>CE marking</b>			
	EN 15102		OK DOP 036-2001-8





# Wall panels & tiles

Mural Revela **New**



7053 Zanzibar



7029 Tanami Gloss ^ Scale 1  
 65 x 37,5 cm 90 x 260 cm / 120 x 260 cm

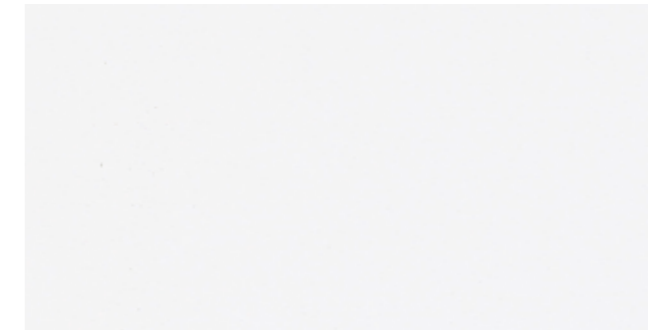

7918 Hanoi  
 65 x 37,5 cm 90 x 260 cm



7868 Ubeda  
 65 x 37,5 cm 90 x 260 cm / 120 x 260 cm



7035 Corabia  
 65 x 37,5 cm 90 x 260 cm



7097 Boulia Gloss  
 65 x 37,5 cm 90 x 260 cm



7869 Baeza  
 65 x 37,5 cm 90 x 260 cm



7053 Zanzibar  
 65 x 37,5 cm 90 x 260 cm



7032 Alanya  
 65 x 37,5 cm 90 x 260 cm / 120 x 260 cm



# Wall panels & tiles

## Mural Revela **New**

 Tile  
65 x 37,5 cm
  XL Panel  
90 x 260 cm /  
XXL Panel  
120 x 260 cm
  100% recyclable

  
Groove/tongue  
assembly



7915 Kampala



7093 Ampara

 65 x 37,5 cm
  90 x 260 cm

^ Scale 1





  
Brilliant effect

7059 Derby Gloss

 65 x 37,5 cm
  90 x 260 cm





7911 Liverpool

 65 x 37,5 cm
  90 x 260 cm



7007 Vilnius

 65 x 37,5 cm
  90 x 260 cm

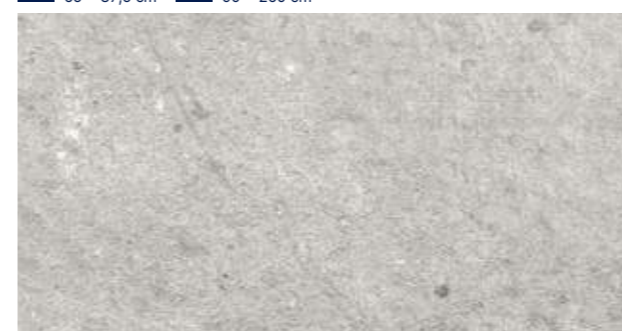

7091 Kamina

 65 x 37,5 cm
  90 x 260 cm / 120 x 260 cm

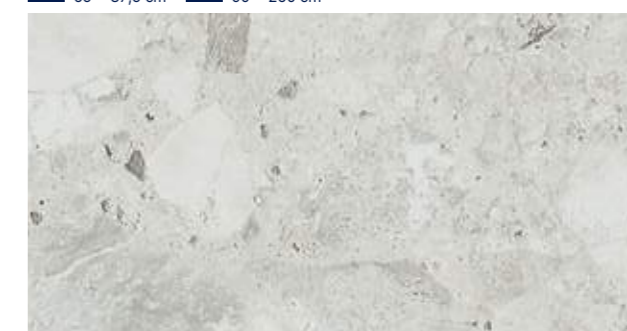

7072 Sarti

 65 x 37,5 cm
  90 x 260 cm





7915 Kampala

 65 x 37,5 cm
  90 x 260 cm



7052 Colima

 65 x 37,5 cm
  90 x 260 cm













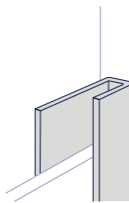

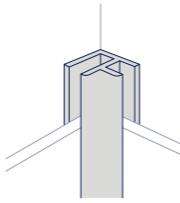
# Wall panels & tiles

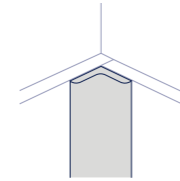
Mural Revela accessories **New**

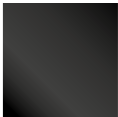
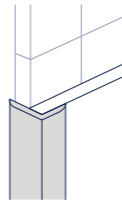

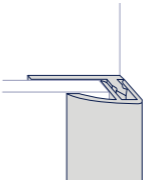
7911 Liverpool

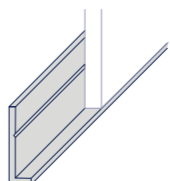
## A complete solution with aluminum profiles for a perfect finish

	<p><b>U finishing trim</b> Code: 0649 + color code</p>		
		Aluminium - 0001	Black - 0002
	<p><b>Universal angle</b> Code: 0644 + color code</p>		
		Aluminium - 0001	Black - 0002
	<p><b>Internal angle</b> Code: 0657 + color code</p>		
		Aluminium - 0001	Black - 0002
	<p><b>L-profile external angle</b> Code: 0653 + color code</p>		
		Aluminium - 0001	
	<p><b>Click finishing profile</b> Code: 0643 + color code</p>		
		Aluminium - 0001	
	<p><b>Start trim</b> Code: 0652 + color code</p>		
		Aluminium - 0001	



# Wall coverings

## Mural Ultra Design / Mural Club / Mural Calypso

### Mural Ultra Design

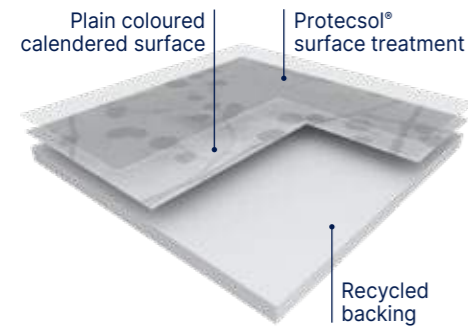

**MURAL ULTRA DESIGN** is a 2m width flexible wall covering vinyl sheet which has a thickness of 1.5mm for an extended durability. Fully resistant to impact (EN 259), **MURAL ULTRA DESIGN** acts as a buffer against damage from beds, trolleys, indoor motorized vehicles and other transportation systems. It is therefore ideal for use as a cladding in large public buildings such as hospitals, care institutions, dental and veterinary surgeries, schools, clean rooms, stores and supermarkets, warehouse and storage areas.

It is made of a 0.10mm printed design layer and a 1.4mm **coloured** resistance layer which will ensure a perfect welding aspect. It has a **B-s2,d0** fire classification (EN 13501-1) which complies with most European fire regulations.

According to ISO 22196, **MURAL ULTRA DESIGN** has anti-bacterial activity against E. coli, S. aureus and MRSA of 99% after 24h00. It is made of a coloured backing which comprises up to **30%** recycled products. It is 100 % recyclable, and the components are 100% compliant with Reach

**MURAL ULTRA DESIGN** benefits from the Protecsol® surface treatment which ensures easy maintenance (EN 233) and avoids staining of chemical products (EN ISO 26987) used in healthcare like iodine alcohol, Betadine, eosin and antibacterial hand gel. It is also resistant to decontamination (class 3 according to ISO 14644-1). The joints are hot-welded to ensure perfect water-tightness.

**MURAL ULTRA DESIGN** can be welded with 2mm flooring to ensure a perfect hygiene by avoiding gaps.

- Easily seam welded to produce continuous surfaces.
- Create a safe and hygienic environment.
- Flexible and easy to cover.
- Ideal for walls and ceilings.
- Recyclable and Eco responsible.

			Mural Ultra Design	Mural Club	Mural Calypso
<b>Description</b>					
Total thickness	EN ISO 24346	mm	1.5	1.00	0.92
Thickness of transparent decorative layer	-	mm	0.10	-	0.10
Thickness of resistance layer	-	mm	1.4	1.00	-
Weight	EN ISO 23997	g/sqm	2450	1780	1610
Width/Length of sheet	EN ISO 24341	cm/ml	200 / 21	200 / 30	200 / 30
<b>Classification</b>					
Product specification	-	-	EN 259-1	EN 259-1	EN 259-1
Fire rating	EN 13501-1	class	B-s2,d0	B-s2,d0	B-s2,d0
<b>Performances</b>					
Colour fastness	EN ISO 105-B02	degree	≥ 6	≥ 6	≥ 6
Surface treatment	-	-	Protecsol®	PUR	-
Chemical products resistance <sup>(1)</sup>	EN ISO 26987	-	OK	OK	OK
Cleanability	EN 233		Washable and brushable	Washable and brushable	Washable and brushable
Emission of particles	ISO 14644-1	class	Class 3	-	-
Anti-bacterial activity (E. coli - S. aureus - MRSA) <sup>(2)</sup>	ISO 22196	-	> 99% inhibits growth	> 99% inhibits growth	> 99% inhibits growth
Resistance to impacts	EN 259-2	-	No visible bursting or cracking	-	-
Scratch resistance	NF EN 14565 annex A	-	No visible deterioration	-	-
Determination of flexibility	EN ISO 24344	-	No damage, no cracking	-	-
Resistance of welded joints	EN 684	N/50mm	≥ 250	-	-
<b>Environment / air quality</b>					
TVOC after 28 days	ISO 16516	µg/ m <sup>3</sup>	<10	-	<100
Recyclability	-	-	100%	100%	100%
Recycled content	-	-	Up to 30%	Up to 30%	Up to 30%
<b>CE marking</b>					
			EN 15102	OK	

(1) Regarding the resistance to chemicals, please download the corresponding leaflet from our website.  
 (2) The implementation of an effective cleaning regime is the most important defence against infection.

### Mural Club

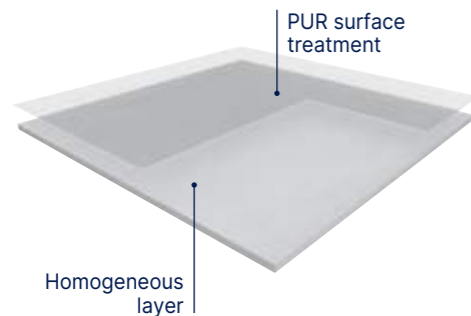

**MURAL CLUB** is a homogeneous wall covering in 2 m width roll and with a B-s2,d0 fire classification. It is designed to be a permanent wall covering. It is hot welded with CR40 welding rods for better hygiene. It is made of calendered layer with colour throughout the whole thickness for a nicer aspect of the welding. This layer comprises at least 10% of recycled products. It does not contain any CMR 1 & 2 component and is 100% compliant with REACH. It is 100% recyclable.

**MURAL CLUB** benefits from a **PUR** surface treatment which provides good resistance to chemical products and makes maintenance easier.

According to ISO 22196, **MURAL CLUB** has **anti-bacterial activity** against E. coli, S. aureus and MRSA of 99% after 24h.

Full resistant to impact, it acts as a buffer against damage from beds, trolleys and indoor motorized vehicles and other transportation systems. **MURAL CLUB** is fully impact resistant and is therefore ideal for use as a cladding in large public buildings such as hospitals care institutions dental and veterinary surgeries, clean rooms, stores and supermarkets, warehouse and storage areas.

### Mural Calypso **New**

See page 296



# Wall coverings

## Mural Ultra Design



Bs2d0

Protecsol®



100% recyclable

### IN STOCK

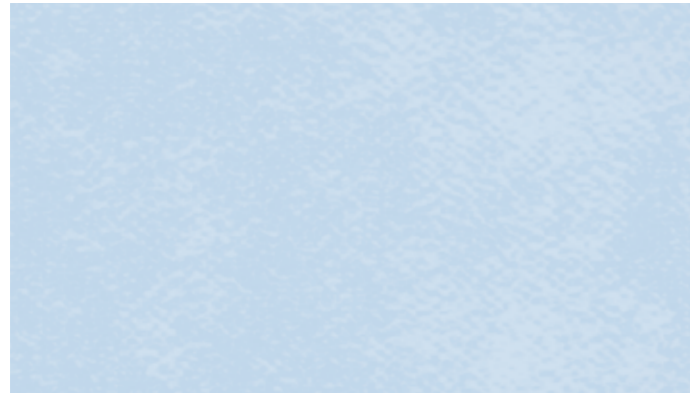

8408 Skyline  
Ⓢ

^ Scale 1



8408 Skyline



8011 Lichen  
Ⓢ



8744 Nordic Milk  
Ⓢ



8309 Lotus  
Ⓢ



8002 Bamboo Lotus  
Ⓢ

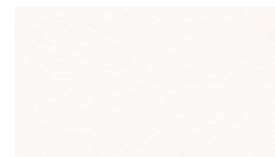

8611 Snow  
Ⓢ



8000 Bamboo Snow Pearl  
Ⓢ

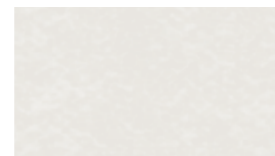

8711 Ice  
Ⓢ



8740 Fabric Silk  
Ⓢ

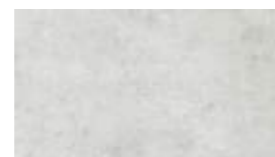

8721 Manhattan Mist  
Ⓢ

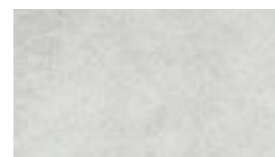

8010 Haze  
Ⓢ



8005 Blossom Snow Pearl  
Ⓢ

### ON DEMAND

Minimum order quantity 500sqm



7025 Arty Beige  
Ⓢ



7026 Arty Grey  
Ⓢ



7311 Cloud Linen  
Ⓢ



7017 Cloud Pink  
Ⓢ



7019 Cloud Terra  
Ⓢ

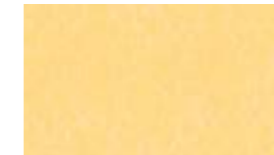

7201 Cloud Moonlight  
Ⓢ



7022 Envol Snow Green\*  
Ⓢ



7023 Envol Snow Skyline\*  
Ⓢ



7013 Ginko Snow Gold\*  
Ⓢ



7014 Ginko Snow Green\*  
Ⓢ



7015 Tropic Skyline  
Ⓢ



7016 Tropic Terra Copper  
Ⓢ

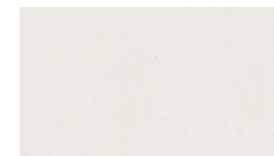

7020 Uni Ice  
Ⓢ



7021 Uni Lotus  
Ⓢ



7027 Verona  
Ⓢ



7024 Venice  
Ⓢ



# Wall coverings

## Mural Club

 Compact  PUR  100% recyclable



0005 Yellow  ^ Scale1

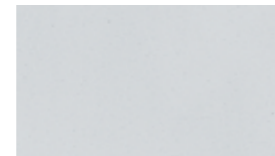

0006 Grey 



0004 Green 

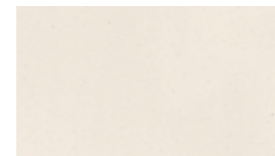

0003 Sand 



0007 Blue 

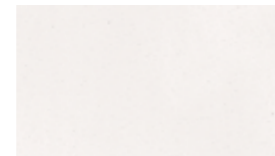

0001 White 

## Mural Calypso **New** (See page 296)

 Compact  Bs2d0  100% recyclable







## Fast Track - High Traffic Tiles

pages 256-277

- 260. GTI®**
- 260. GTI® Max
- 260. GTI® Pure
- 264. GTI® EL5

**268. Attraction®**

**274. Design tile** **New**

**276. R-tile** **New**



# Fast Track - High Traffic Tiles

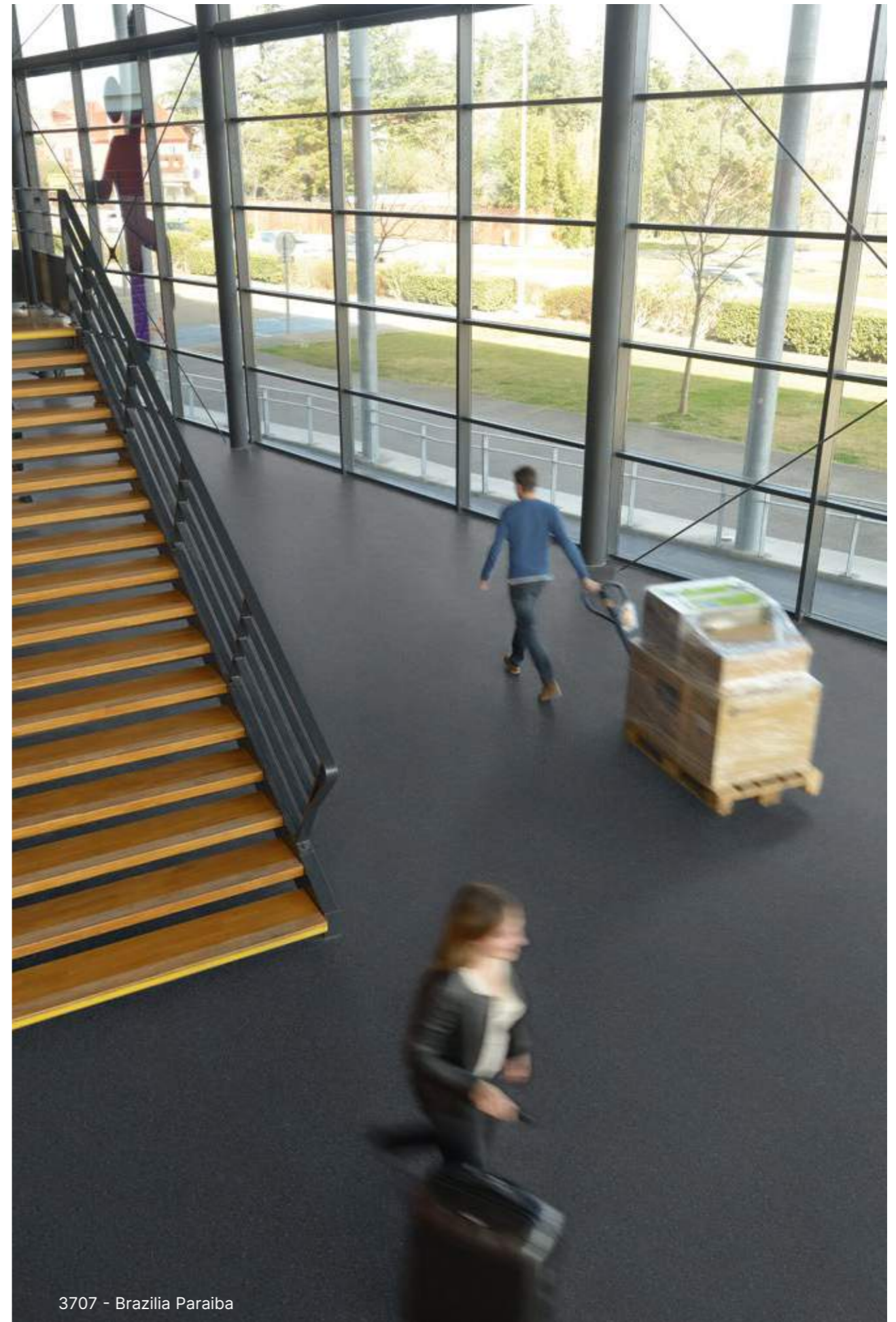
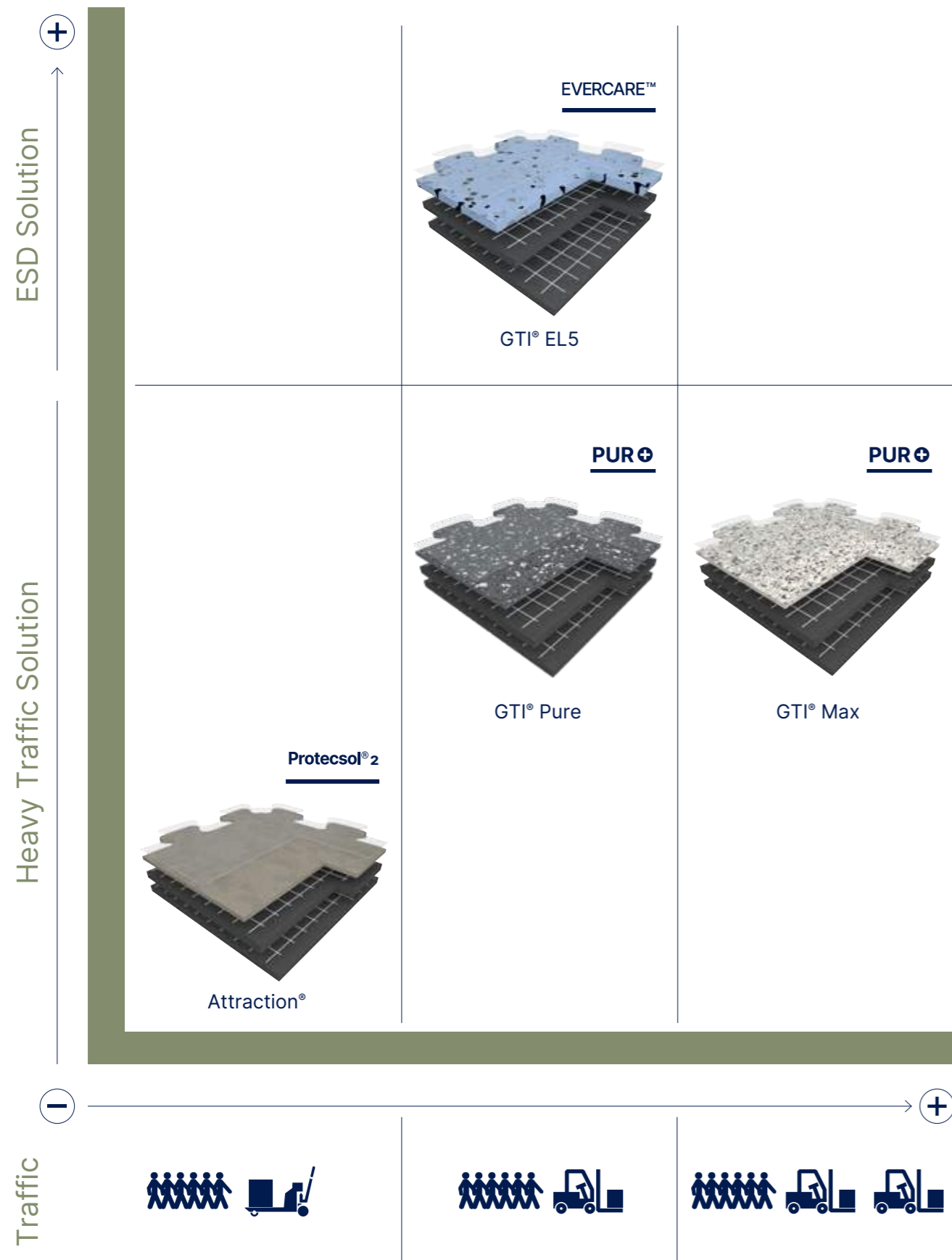

3707 - Brazilia Paraiba

Fast Track  
High Traffic  
Tiles



# Fast Track - High Traffic Tiles

## GTI® Max - GTI® Pure

### GTI® Max Connect & Cleantech

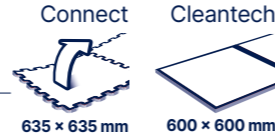

#### GTI® Max Connect

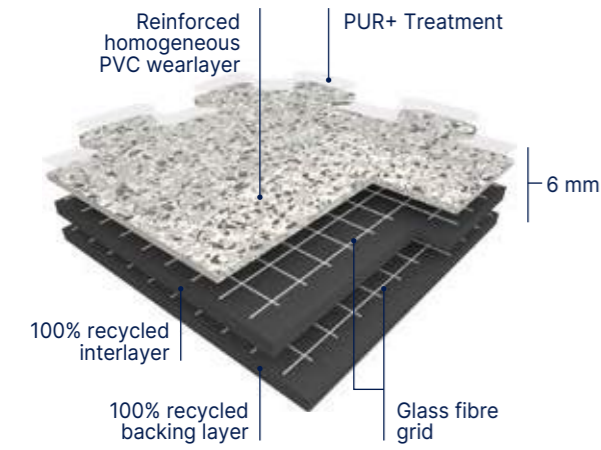

#### GTI® Max Cleantech

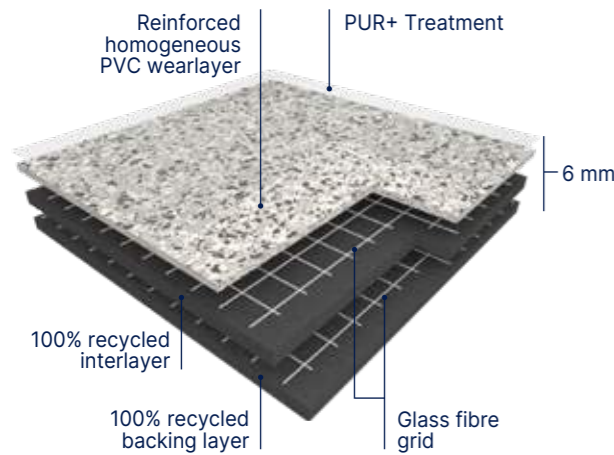

### GTI® Pure Connect

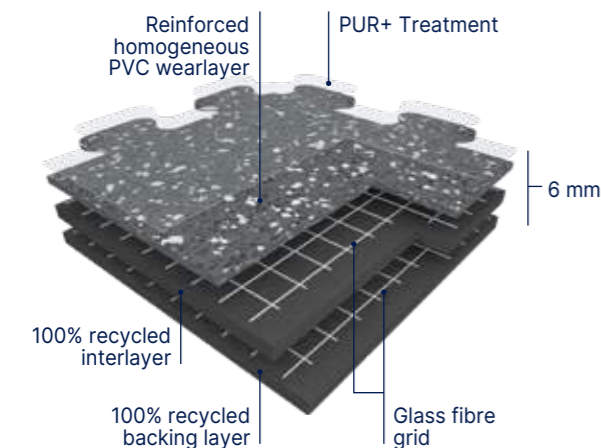

**GTI® Max** is a multi-layered interlocking looselay vinyl tile with polyurethane treatment (**PUR+**), 6 mm thick with a dovetail joint for the **Connect** configuration and with welded joints for the **Cleantech** configuration.

GTI® is manufactured by Gerflor using a continuous high pressure process, abrasion group T. The **GTI® Max** wearlayer is reinforced by specific oblong fillers that offers an outstanding resistance to traffic.

**GTI® Max** is reinforced with 2 glass fibre grids on either side of an intermediate pressed homogeneous layer.

**GTI® Max** backing is a 4 mm thick black pressed homogeneous sheet, its surface is a coloured and reinforced homogeneous sheet 2 mm thick. The product is 100% recyclable.

**GTI® Max** is made with a phthalate free plasticizer.

**GTI® Access** are ramps that provide continuity between the tile and the existing floor.

**GTI® Corner** enable covering of inaccessible corners or finishing central patterns.

**GTI® Pure** is a multi-layered interlocking looselay vinyl tile with polyurethane treatment (**PUR+**), 6 mm thick with a dovetail joint for the **Connect** configuration.

**GTI® Pure** is manufactured by Gerflor using a continuous high pressure process, abrasion group T. The **GTI® Pure** wearlayer is a Pure vinyl homogeneous wear layer with no filler, incorporating very densely pressed coloured chips and without any transparent wear layer. It offers an outstanding abrasion and scratch resistance and an high resistance to traffic.

**GTI® Pure** is reinforced with 2 glass fibre grids on either side of an intermediate pressed homogeneous layer.

**GTI® Pure** backing is a 5 mm thick black pressed homogeneous sheet, its surface is a colored and reinforced homogeneous sheet 1 mm thick. The product is 100% recyclable.

**GTI® Pure** is made with a phthalate free plasticizer.



- Resistant to heavy traffic
- Fast renovation: can be installed over existing floorcovering
- No subfloor preparation, no adhesive and no production stop (no loss of money)

- Polyurethane surface treatment **PUR+** for ease of maintenance
- 6 Standard logos: Mix and match colours to create corners and walkways

	GTI® Max		GTI® Pure	
<b>Description</b>				
Total thickness	EN ISO 24346	mm	6	6
Wearlayer thickness	EN ISO 24340	mm	2	1
Weight	EN ISO 23997	g/m <sup>2</sup>	9365	8930
Size	EN ISO 24342	mm	635 x 635 Connect 600 x 600 Cleantech (without dovetail) <sup>(1)</sup>	635 x 635 Connect
<b>Classification</b>				
Norm / Product specification	-	-	EN ISO 10582	EN ISO 10582
European classification	EN ISO 10874	class	34-43	34-43
Fire rating	EN 13501-1	class	Bfl-s1	Bfl-s1
Static electrical propensity	EN 1815	kV	< 2	< 2
Slip resistance wet: ramp test with oil	EN 16165:2021 - Appendix B (DIN 51 130)	class	R10	R10
Pendulum test	BS7976	-	Concrete emboss <sup>(2)</sup> : +36 PTV	Rice emboss <sup>(2)</sup> : Soft emboss <sup>(2)</sup>
<b>Performances</b>				
Wear resistance	EN 660.2	mm <sup>3</sup>	≤ 2.0	≤ 2.0
Wear group	-	group	T	T
Type Binder content	EN ISO 10582	type	I	I
Dimensional stability	EN ISO 23999	%	≤ 0.15	≤ 0.15
Residual indentation	EN ISO 24343-1	mm	≤ 0.10	≤ 0.10
Castor chair test (type W)	ISO 4918	-	OK	OK
Shore Hardness	EN ISO 868	H <sub>D</sub>	≥ 55	-
Shifting resistance	CAHIER CSTB 3562	N/mm <sup>2</sup>	≥ 30	-
Thermal conductivity	EN ISO 10456	W/(m.k)	0.25	0.25
Colour fastness	EN ISO 105-B02	degree	≥ 6	≥ 6
Surface treatment	-	-	PUR+	PUR+
Chemical products resistance	EN ISO 26987	-	OK	OK
<b>Environment / indoor air quality</b>				
TVOC after 28 days	ISO 16000-6	microgram/m <sup>3</sup>	< 10	< 10
Certification	-	-	Floorscore®	Floorscore®
<b>CE marking</b>				
CE		EN 14041		

(1) Available upon request

(2) +36 PTV only for 7 references GTI® Max: Ermelino - Ora - Bora - Libeccio - Grecale - Sirocco - Tramontana

#### GTI® LOGOS



0001 Caution 0002 Forklift 0006 Pedestrian 0003 Arrow 0005 No entry 0004 Stop



# Fast Track - High Traffic Tiles

GTI® Max - GTI® Pure



## Rice Emboss

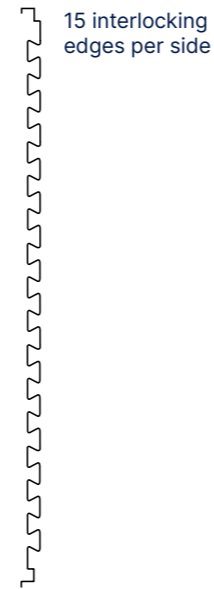
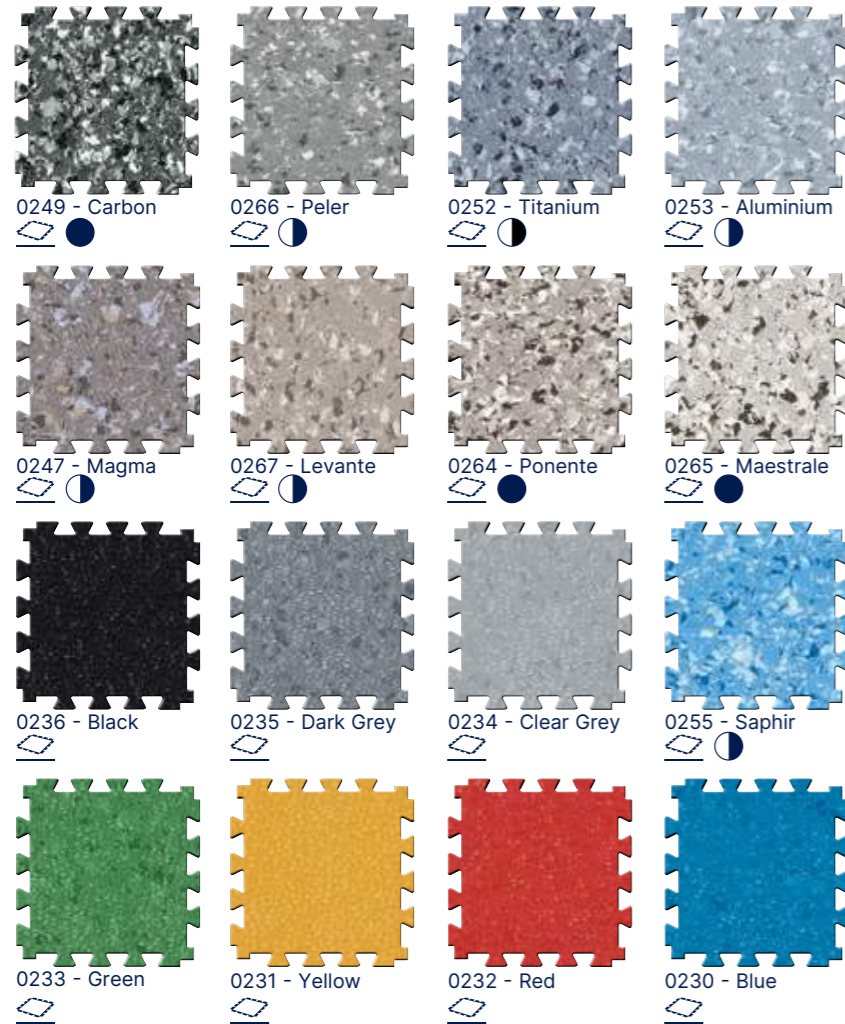

## Concrete Emboss

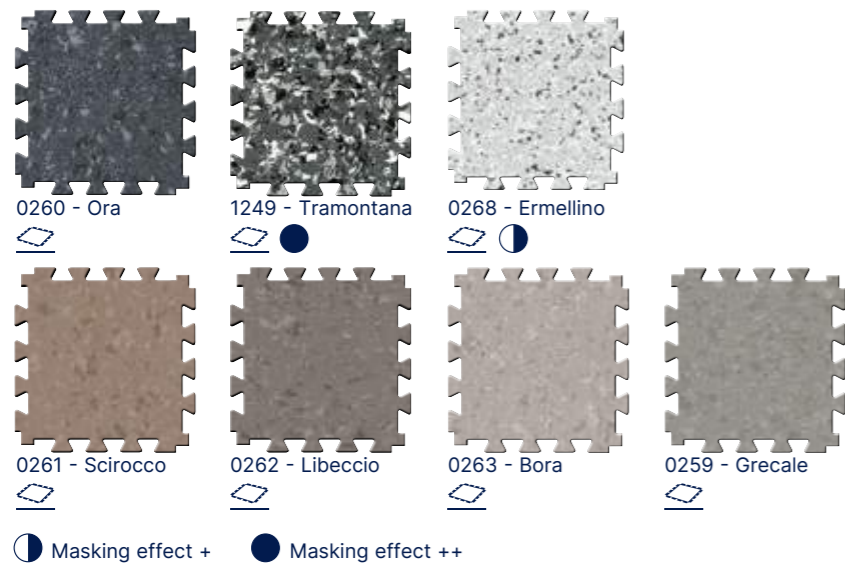

● Masking effect + ● Masking effect ++

On order Moq: 500 sqm

All these colours are available in GTI® MAX CLEANTECH. For more details please contact your Gerflor representative.

GTI® Max - GTI® Pure



## Soft Emboss\*

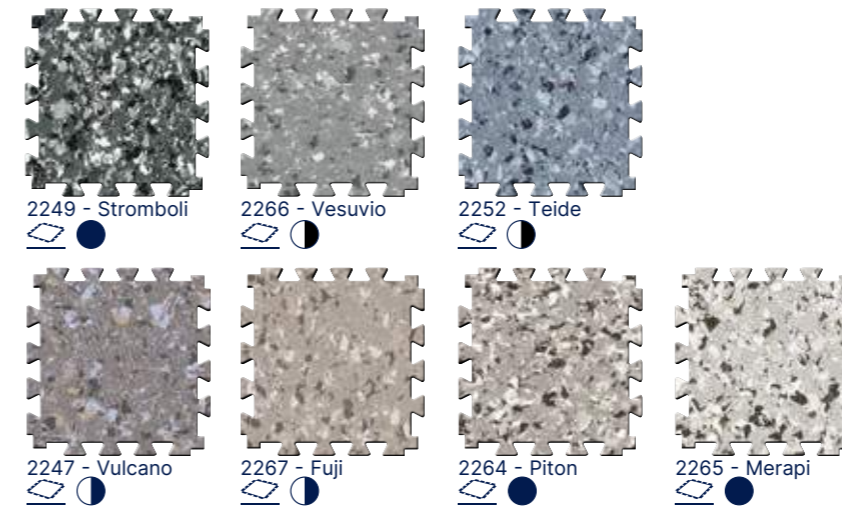

\*On order Moq: 500 sqm

## GTI® Pure



## Soft Emboss\*



\*On order Moq: 500 sqm

● Masking effect + ● Masking effect ++

## Accessories GTI® Max - GTI® Pure

Aluminium ramp 5-6 mm



Aluminium Ramp 5-6 mm / Ref. 0505 + Aluminium Corner 5-6 mm / Ref. 1513 See page 384

High traffic pvc Ramp 6 mm



Ref. 0500 See page 384

Entrance Mat for GTI®



Romat GT - Ref. 1719



Esplanade 9000 - Ref. 1700

Corner & Access



GTI® ACCESS 635 x 320 mm

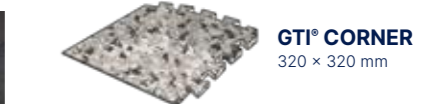

GTI® CORNER 320 x 320 mm

For more information, please refer to our GTI® MAX brochure.



# Fast Track - High Traffic Tiles

## GTI® EL5

### GTI® EL5 Connect & Cleantech

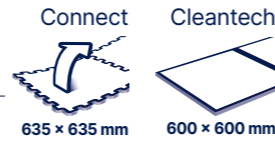

#### GTI® EL5 CONNECT

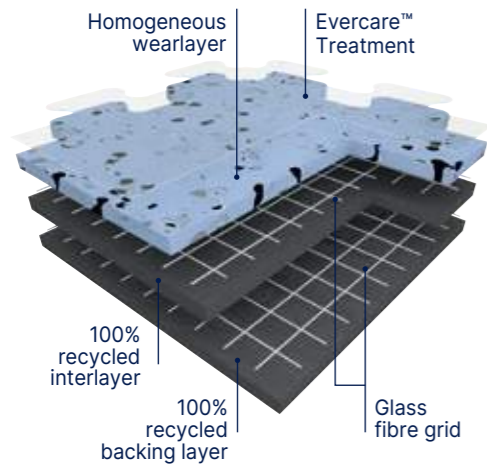

**GTI® EL5 Connect is a multi-layered looselay vinyl tile, 6 mm thick, reinforced with 2 glass fibre grids.**  
GTI® EL5 Connect tiles can be installed using interlocking system with dove tails.

**GTI® EL5 Cleantech is a multi-layered looselay vinyl tile, 6 mm thick, reinforced with 2 glass fibre grids.**  
GTI® EL5 Cleantech is available in **square format with welded joints** for clean environments and watertight systems requirements.

**GTI® EL5** wearlayer is 2 mm vinyl homogeneous manufactured with continuous high pressure process, abrasion group P. It offers an outstanding resistance to traffic.

This floorcovering is treated with **Evercare™** technology: the latest improvements in polyurethane surface treatment obtained by UV laser cross-linking. Evercare™ offers **easy maintenance and resistance against staining** of chemical products used in healthcare like betadine, eosin or anti-bacterial hand gel; **and decontamination protocols.**

This treatment has excellent maintenance characteristics; it requires no wax for life!

The carbon encapsulated granules throughout its full thickness and the **conductive backing** and **conductive surface treatment** ensure optimal and consistent conductive properties throughout its full life expectancy.

- $5 \times 10^4 \leq Rt \leq 10^6$  according to **EN 1081**

It has permanent antistatic properties.

- **< 2000 V** according to **EN 1815**

**The product is non-emissive of volatile organic compounds with < 10 microgram/m³ (TVOC after 28 days ISO 16000-6).**

#### GTI® EL5 CLEANTECH

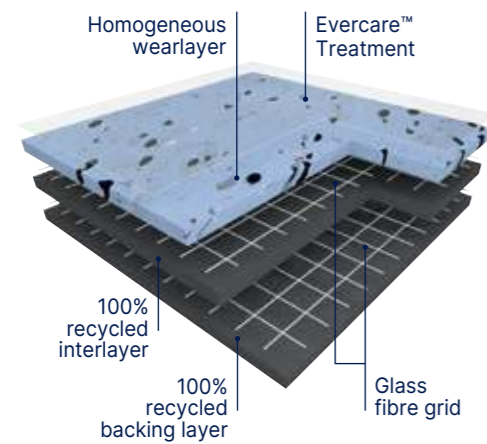

#### Complementary Finishes

GTI® EL5 Connect		GTI® EL5 Cleantech	
		2715	Access
2717	Access	2716	Corner
		2722	Conductive Welding Rods



#### Connect

- Fast Installation
- Resistance to heavy traffic

#### Cleantech

- Watertight System (hot welding)
- Resistance to heavy traffic

#### GTI® EL5

Description			
Total thickness	EN ISO 24346	mm	6
Wearlayer thickness	EN ISO 24340	mm	2
Weight	EN ISO 23997	g/m²	9240
Size	EN ISO 24342	mm	635 x 635 (Connect) 650 x 650 (Cleantech)
Classification			
Norm / Product specification	-	-	EN ISO 10582
European classification	EN ISO 10874	class	34-43
Fire rating	EN 13501-1	class	Bfl-s1
Electrical resistance <sup>(1)</sup>	EN 1081	Ohm	$5 \times 10^4 \leq Rt \leq 10^6$
Static electrical propensity	EN 1815	kV	< 2
Slip resistance wet: ramp test with oil	EN 16165:2021 - Appendix B (DIN 51 130)	class	R9
Performances			
Wear resistance	EN 660.2	mm³	≤ 4.0
Wear group	NF 189	group	P
Type Binder content	EN ISO 10582	type	I
Dimensional stability	EN ISO 23999	%	≤ 0.25
Castor chair test (type W)	ISO 4918	-	OK
Shore Hardness	EN ISO 868	H <sub>b</sub>	≥ 90
Thermal conductivity	EN ISO 10456	W/(m.k)	0.25
Colour fastness	EN ISO 105-B02	degree	≥ 6
Surface treatment	-	-	Evercare™
Chemical products resistance	EN ISO 26987	-	OK
Environment / indoor air quality			
TVOC after 28 days	ISO 16000-6	microgram/m³	< 10
Certification	-	-	Floorscore®
CE marking			



EN 14041



(1) Measured before installation





# Fast Track - High Traffic Tiles

GTI® EL5



 **Removable R9 Evercare™**

GTI® EL5 CONNECT



635 × 635 mm

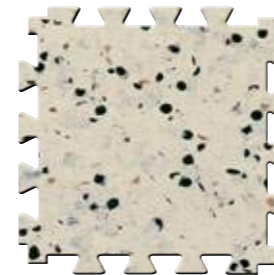

0353 Beige

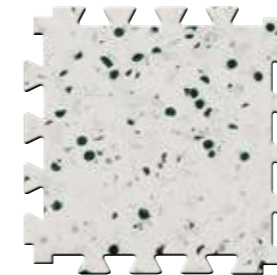

0350 Light Grey

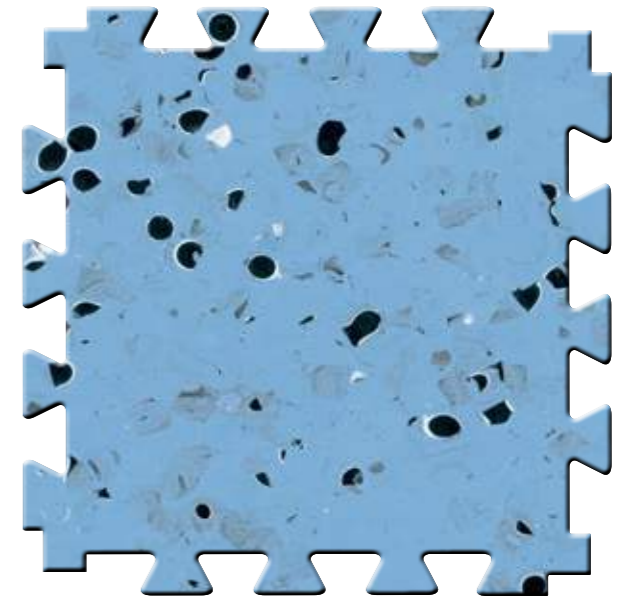

0354 Blue

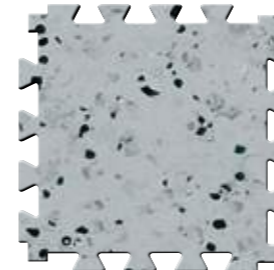

0352 Grey

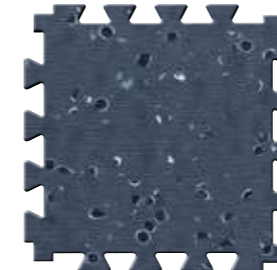

0351 Black

^ Scale 1

GTI® EL5 CLEANTECH

 **Removable R9 Evercare™**

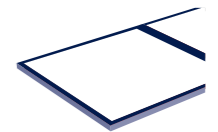

650 × 650 mm

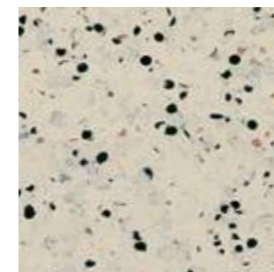

0353 Beige

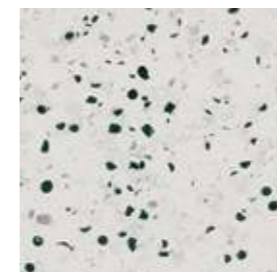

0350 Light Grey

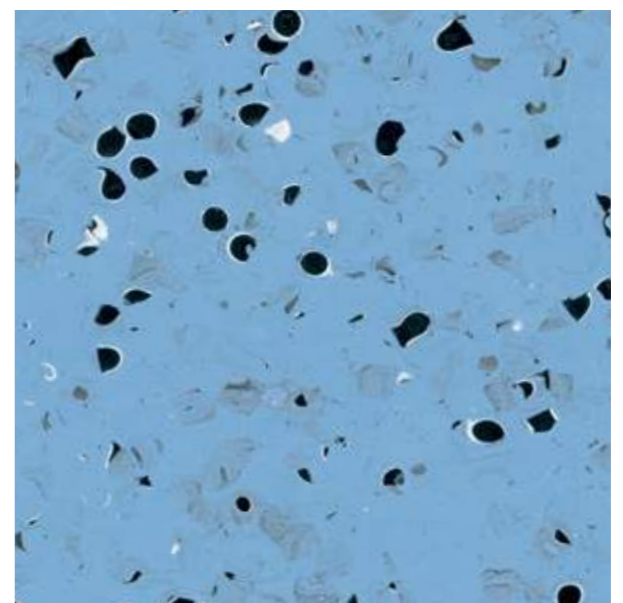

0354 Blue

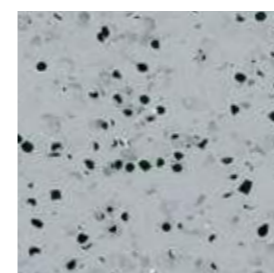

0352 Grey

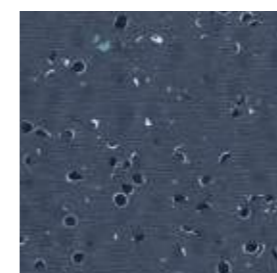

0351 Black

^ Scale 1



# Fast Track - High Traffic Tiles

Attraction®

Attraction® Connect & Cleantech

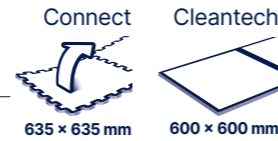

Attraction® connect

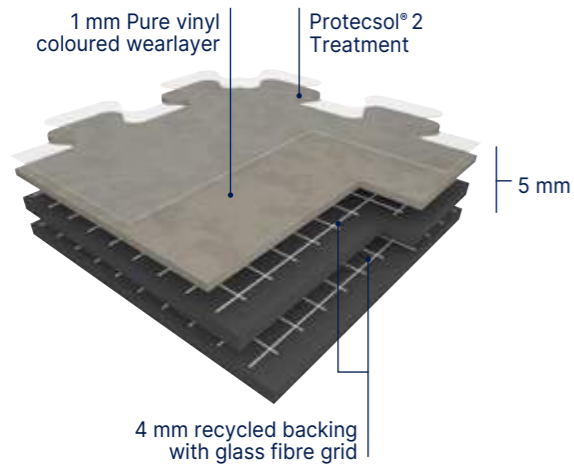

Attraction® is a semi-flexible tile constructed by compacting, at high temperature and over 3000 T, a 4 mm recycled backing and a 1 mm **Pure vinyl wear layer. This wear layer is incorporating very densely pressed coloured chips, with a mat finishing and without a transparent wear layer.** The product comprises a compact backing which is pressed and reinforced with two glass fibre grids.

Attraction® has a unique dovetail joint which allows fast loose lay installation and replacement.

Attraction® is treated with **Protecsol® 2**, a surface treatment obtained by UV laser crosslinking.

This **Protecsol® 2** ensures easy maintenance and eliminates permanently the need for acrylic emulsion (metallisation). It avoids staining of chemical products used in healthcare like iodine alcohol, Betadine, eosin and anti-bacterial hand gel.

It has a Bfl-s1 fire classification in accordance with standard EN 13501-1. The products emission rate of volatile organic compounds is **< 10 microgram/m³ (TVOC after 28 days – ISO 16000-6)**.

It is made with a phthalate free plasticizer.

It is made of 100% controlled recycled materials.

It does not contain any heavy metals or CMR 1&2 and they are 100% compliant with REACH.

It is 100% recyclable and made with up to 80% recycled content.

Attraction® cleantech

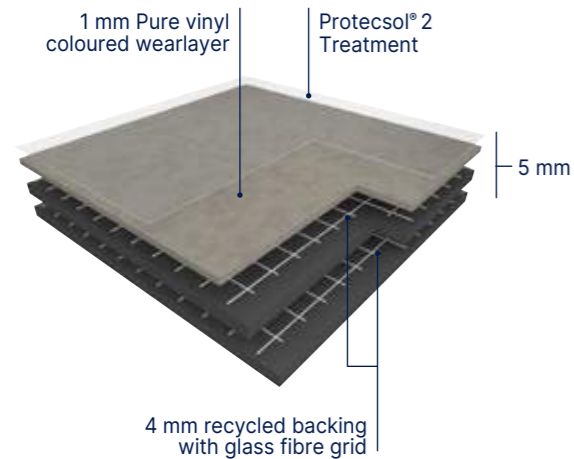

Attraction®



The Taralay Premium range in the looselay Attraction® format for an easy and longlasting renovation!

- Fast track and easy installation
- No immobilisation of the premises and no loss of turnover
- Little or no subfloor preparation
- Low maintenance cost: UV cured polyurethane Protecsol® 2 treatment

Attraction®			
Description			
Total thickness	EN ISO 24346	mm	5.00
Wearlayer thickness	EN ISO 24340	mm	1.00
Weight	EN ISO 23997	g/m²	7460
Size	EN ISO 24342	mm	635 × 635 Connect 600 × 600 Cleantech (without dovetail) <sup>(1)</sup>
Classification			
Norm / Product specification	-	-	EN ISO 10582
European classification	EN ISO 10874	class	34-43
Fire rating	EN 13501-1	class	Bfl-s1
Static electrical propensity	EN 1815 IEC 61340-4-5	kV V	< 2
Slip resistance wet: ramp test with oil	EN 16165:2021 – Appendix B (DIN 51 130)	class	R10
Performances			
Wear resistance	EN 660.2	mm³	≤ 2.0
Wear group	-	group	T
Type Binder content	EN ISO 10582	type	I
Dimensional stability	EN ISO 23999	%	≤ 0.15
Residual indentation	EN ISO 24343-1	mm	≤ 0.10
Castor chair test (type W)	ISO 4918	-	OK
Thermal conductivity	EN ISO 10456	W/(m.k)	0.25
Colour fastness	EN ISO 105-B02	degree	≥ 6
Surface treatment	-	-	Protecsol® 2
Chemical products resistance	EN ISO 26987	-	OK
Environment / indoor air quality			
TVOC after 28 days	ISO 16000-6	microgram/m³	< 10
Certification	-	-	Floorscore®
CE marking			
CE		EN 14041	

(1) Available upon request



# Fast Track - High Traffic Tiles

Attraction®



**Removable R10 ProtecsoI® 2**

**100% recyclable**

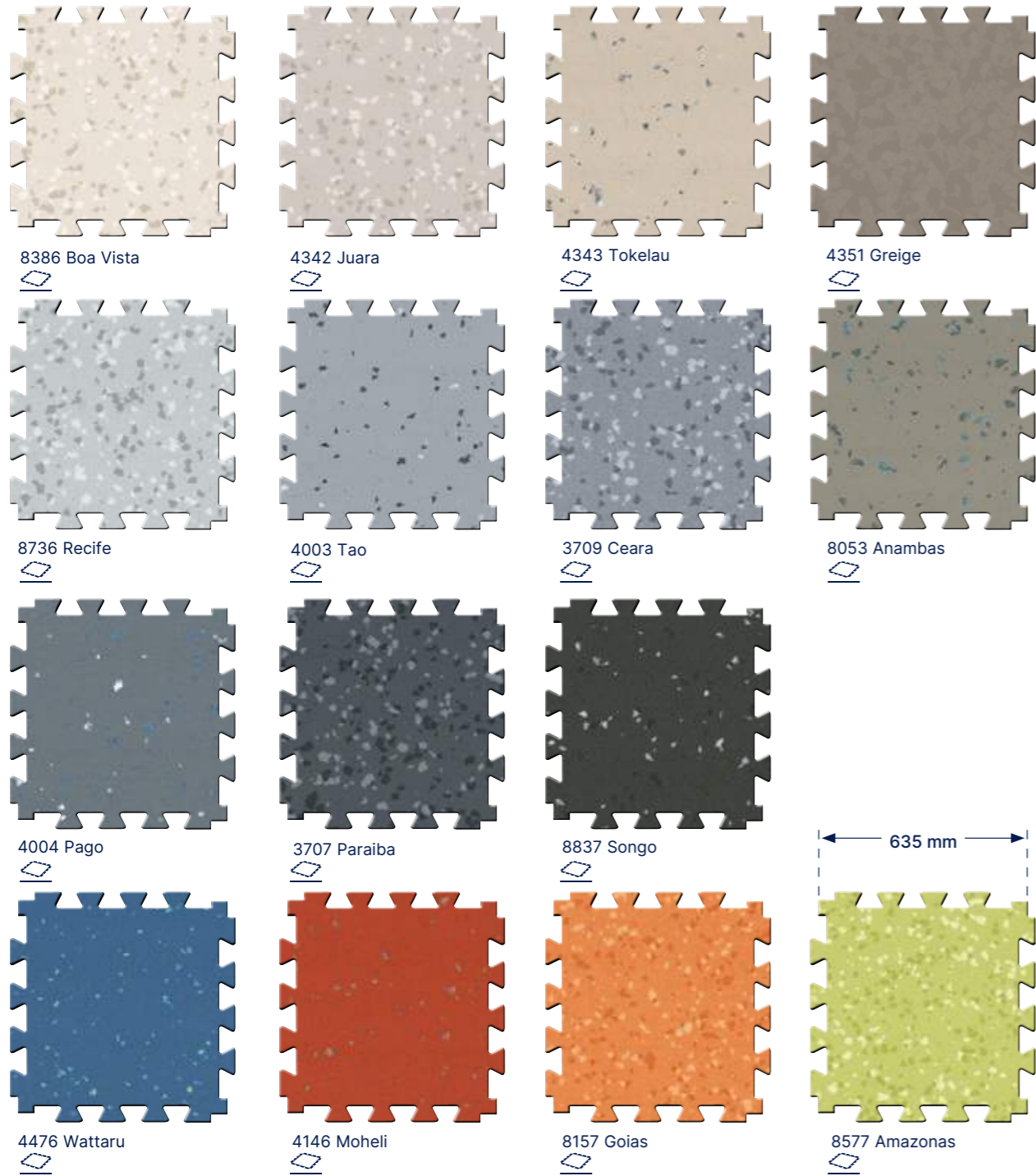

15 interlocking edges per side

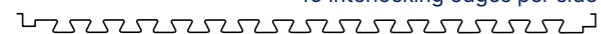

All these colours are available in ATTRACTION® CLEANTECH. For more details please contact your Gerflor representative.

# Attraction® - Neopolis



**Removable R10 ProtecsoI® 2**

**100% recyclable**

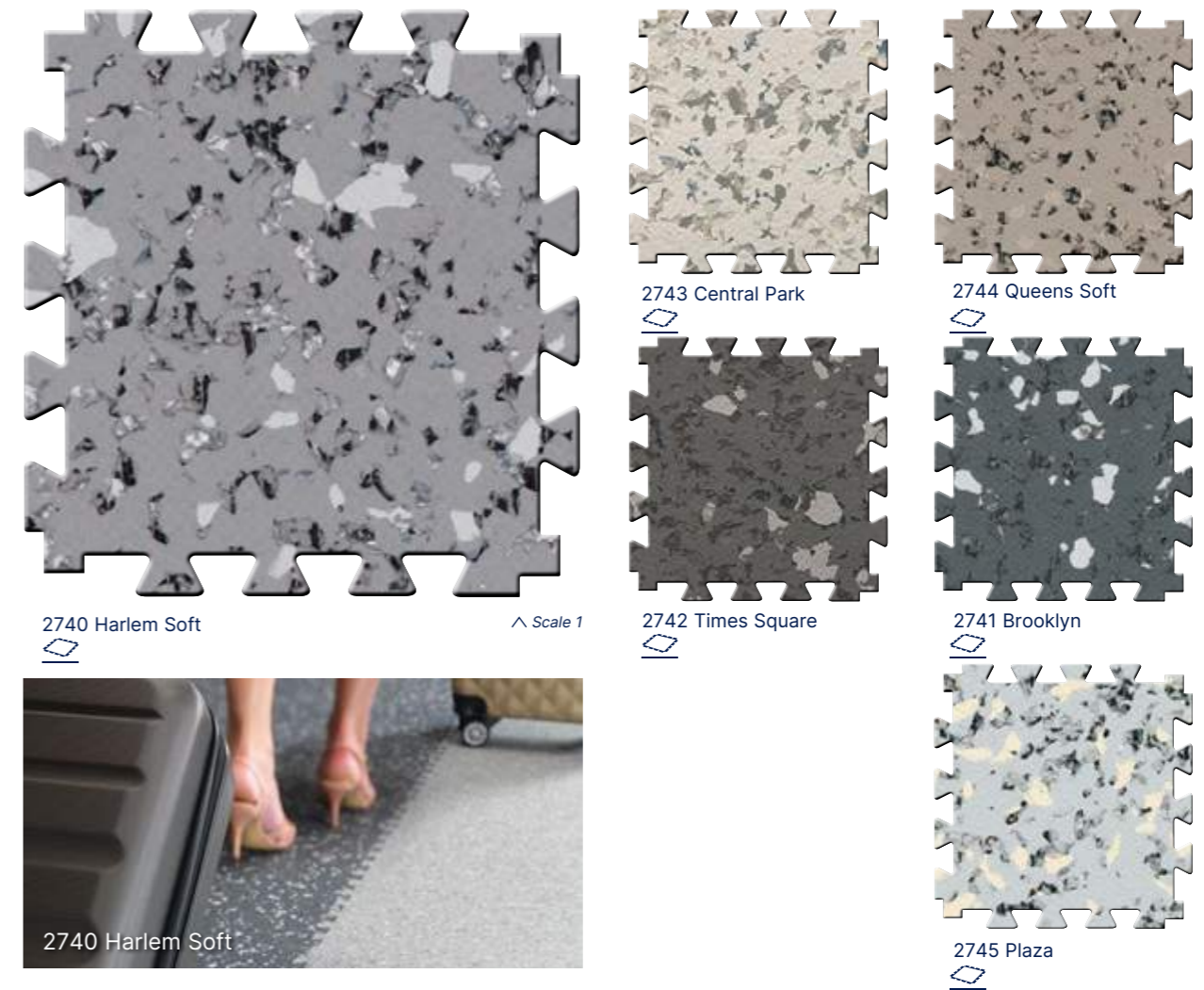

## Accessories Attraction®

Aluminium ramp srewed - 5-6 mm



0505



1513

Entrance Mat for Attraction®



Esplanade 9000 - Réf. 1700

Corner & Access

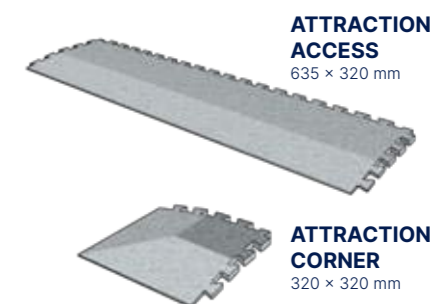

**ATTRACTION ACCESS**  
635 x 320 mm

**ATTRACTION CORNER**  
320 x 320 mm

See page 384

For more information, please refer to our Attraction® brochure.

Fast Track  
High Traffic  
Tiles



# Fast Track - High Traffic Tiles

## Design Tile - R-Tile New

### Design Tile



**Design Tile** is a synthetic, decorative, flexible, antistatic, abrasion group T floor covering. It consists in a multi-layered tile with a 0,70 mm thick transparent wear layer and a printed film on an injected molded backing. The overall thickness is 7,8 mm.

**Design Tile** is an interlocking hidden dovetail loose lay tiles with grout edges. The resistance to use (commercial / industrial use) of 34 / 43 according to EN-ISO 10874 and has Bfl -s1 class for smoke emission according to EN 13501-1.

**Design Tile** is made from ultra-stable 100% recyclable material with up to 80% of recycled content. It is REACH compliant. The product emission rate of organic compounds is < 100 micrograms/m<sup>3</sup> (TVOC <28 days - ISO 16000-6).

### R-Tile

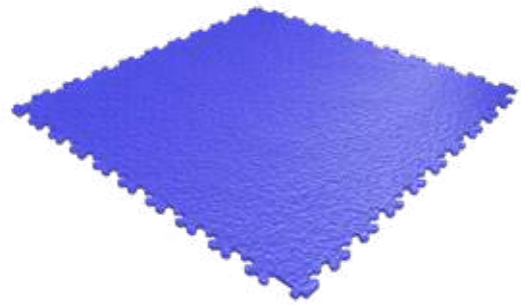

**R-Tile** is a synthetic, flexible, antistatic, floor covering. It consists in an injected molded backing. The overall thickness is 5, 7 or 9 mm.

**R-Tile** is an interlocking dovetail loose lay tile. The resistance to use (commercial / industrial use) of 34 / 43 according to EN-ISO 10874 and has Bfl -s1 class for smoke emission according to EN 13501-1.

**R-Tile** is made from ultra-stable 100% recyclable material with up to 80% of recycled content. It is REACH compliant. The product emission rate of organic compounds is < 100 micrograms/m<sup>3</sup> (TVOC <28 days - ISO 16000-6).

### Do not forget the finishes & tools

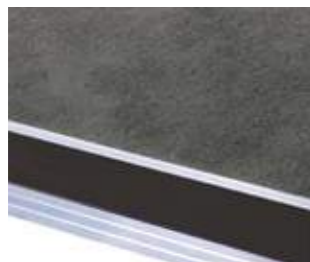

**Aluminum Ramp**  
Screwed - 2,5m  
Code: 0663 with Insert (Black, Light Grey, Dark Grey) Code: 4096



**Diminishing profile - 2m**  
Code: 0490



**Entrance mat**  
Esplanade 9000  
Code: 1700



**Anti Bounce Mallet**  
Code: 5951

**PVC Ramp**  
2m - Code: 7032



#### Design Tile:

- Ceramic tile look
- Adhesive free
- Rolling traffic compliant\*
- Renovation over ceramic
- Circularity: 100% re-usable or re-cyclable

\* Conditions specified in installation guidelines

#### R-Tile:

##### Performance

- Withstand Mechanical traffic
- 10 colors available in 5 mm, 7 mm, 9 mm

##### Easy Installation

- Adhesive Free Interlocking system: Easy to remove and reuse
- Minimal subfloor preparation: easy to install

##### Safety & Well being

- R10 Slip resistance
- Walking comfort

	Design Tile		R-Tile		
<b>Description</b>					
Total thickness	EN ISO 24346	mm	7,8	5	7 9
Wearlayer thickness	EN ISO 24340	mm	0,70	-	-
Weight	EN ISO 23997	g/m <sup>2</sup>	12 000	7000	9200 12800
Size	EN ISO 24342	mm	457 × 457 / 614 × 614	503 × 503	
<b>Classification</b>					
Norm / Product specification	-	-	EN ISO 10582	EN ISO 10581	
European classification	EN ISO 10874	class	34-43	34-43	
Fire rating	EN 13501-1	class	Bfl-s1	Bfl-s1	
Static electrical propensity	EN 1815	kV	< 2	< 2	
Slip resistance wet: ramp test with oil	EN 16165:2021 - Appendix B (DIN 51 130)	class	R10	R10	
<b>Performances</b>					
Wear resistance	EN 660.2	mm <sup>3</sup>	≤ 2,0	-	
Wear group	-	group	T	-	
Type Binder content	EN ISO 10582	type	I	I	
Curling	EN ISO 23999	mm	≤ 1	-	
Dimensional stability	EN ISO 23999	%	≤ 0,15	≤ 0,15	
Residual indentation	EN ISO 24343-1	mm	≤ 0,05	≤ 0,10	
Castor chair test (type W)	ISO 4918	-	OK	OK	
Flexibility	ISO 24344 METHOD A	-	-	No cracking	
Shore Hardness	EN ISO 868	H <sub>d</sub>	> 60	≥ 40	
Thermal conductivity	EN ISO 10456	W/(m.k)	0,25	0,25	
Colour fastness	EN ISO 105-B02	degree	≥ 6	≥ 6	
Surface treatment	-	-	PUR+	-	
Chemical products resistance	EN ISO 26987	-	OK	OK	
<b>Environment / indoor air quality</b>					
TVOC after 28 days	ISO 16000-6	microgram/m <sup>3</sup>	< 100	< 100	
<b>CE marking</b>					
CE			EN 14041		
<b>Conditions of use</b>					
Rolling traffic	Frequency	-	-	Occasional (1x per day max.)	
	Type of wheeled traffic	-	-	Manual pallet truck	Electric pallet truck and forklift
	Max total load	kg	-	600	1500 3000
	Max contact pressure	kg/cm <sup>2</sup>	-	40	60 80



# Fast Track - High Traffic Tiles

Design Tile **New**

 Removable R10 PUR+  100% recyclable

614 × 614 mm format



1698 Marmetta Beige



1696 Acero Light  
Light grey grout



1695 Manhattan Cloud  
Light grey grout

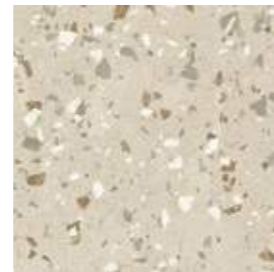

1698 Marmetta Beige  
Brown grout



1694 Manhattan Dust  
Light grey grout

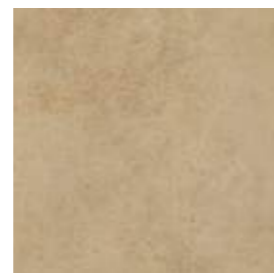

1697 Acero Beige  
Light grey grout



1693 Manhattan Grey  
Dark grey grout

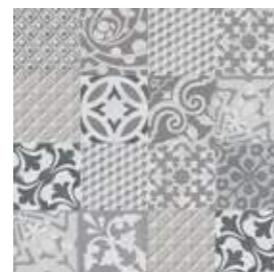

1699 Luberon Grey  
Light grey grout



1692 Manhattan Storm  
Dark grey grout

 Removable R10 PUR+  100% recyclable

457 × 457 mm format



1551 Vintage Sand

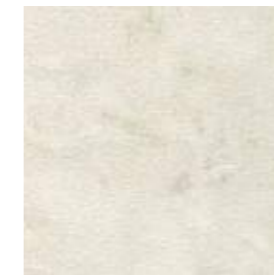

1548 Limestone  
Light grey grout

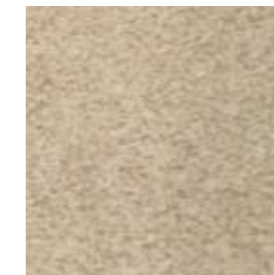

1555 Sandstone  
Light grey grout

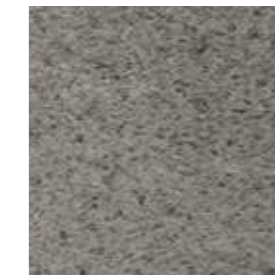

1545 Clay  
Dark grey grout

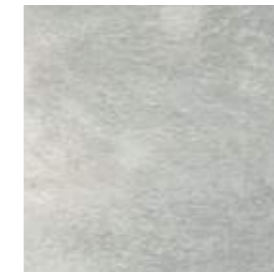

1546 Granite  
Dark grey grout



1544 Shalestone  
Dark grey grout

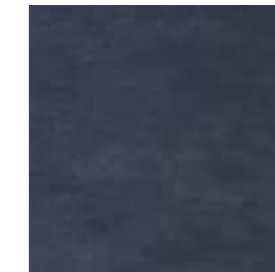

1547 Volcano  
Black grout



1553 Terrazzo Cream  
Dark grey grout

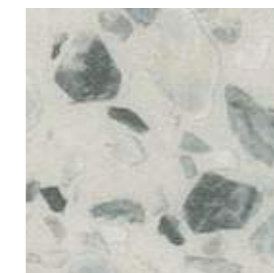

1554 Terrazzo Grey  
Dark grey grout



1549 Polished Concrete  
Light grey grout



1550 Vintage Maple  
Light grey grout



1552 Vintage Ash  
Light grey grout



1551 Vintage Sand  
Brown grout



# Fast Track - High Traffic Tiles

R-Tile **New**



Removable

R10



100% recyclable



7045 Light Grey / 5005 Blue



7045 Light Grey



7015 Dark Grey



9004 Black



1018 Yellow



5005 Blue



6005 Green



3020 Red



3016 Maroon



1002 Beige

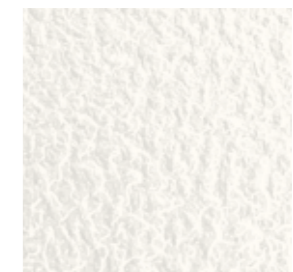

9003 White

Fast Track  
High Traffic  
Tiles





# Technical Solutions

pages 278-297

## 282. EL5 / EL7 Solutions Dissipative & conductive floors

- 284. Dissipative floors
- 284. Mipolam EL7
- 284. Mipolam Robust EL7

- 285. Conductive floors
- 285. Mipolam EL5
- 285. Mipolam Technic EL5  
GTI® EL5 (See page 264)

## 286. Safety Floorings

- 288. Tarasafe Ultra Sparclean® **New**
- 289. Tarasafe Standard **New** - Plus - Super  
Tarasafe Ultra H<sub>2</sub>O (See page 293)

## 290. Shower System

- 292. Tarasafe H<sub>2</sub>O **New**
- 293. Tarasafe Ultra H<sub>2</sub>O
- 294. Tarasafe Design
- 296. Mural Calypso **New**



# Technical solutions

EL5 / EL7  
Solutions

## Dissipative Floors

EN 1081 ( $\Omega$ ):  $10^6 \leq Rt \leq 10^8$

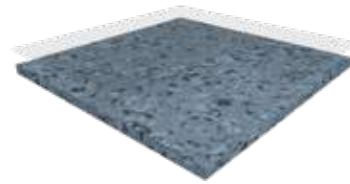

Mipolam EL7



Mipolam Robust EL7

## Conductive Floors

EN 1081 ( $\Omega$ ):  $10^4 \leq Rt \leq 10^6$



Mipolam EL5

EN 1081 ( $\Omega$ ):  $10^4 \leq Rt \leq 10^6$

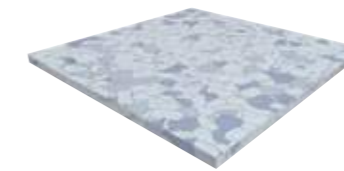

Mipolam Technic EL5

EN 1081 ( $\Omega$ ):  $5 \times 10^4 \leq Rt \leq 10^6$

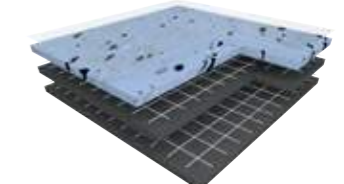

GT1 EL5

Slip Resistant  
Floorings

## SparClean® Treatment

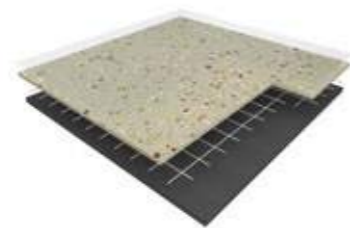

Tarasafe Ultra

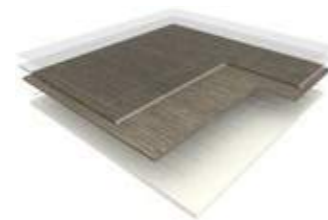

Tarasafe Design

## PUR Treatment

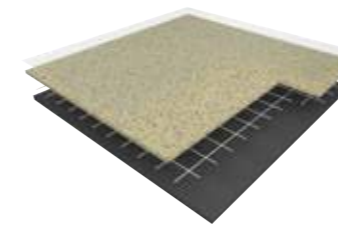

Tarasafe Standard

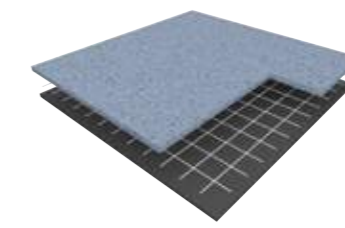

Tarasafe Super

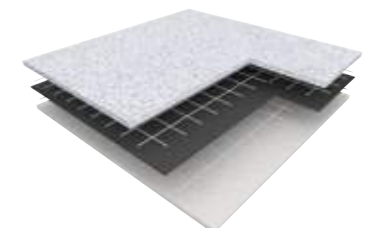

Tarasafe Plus

Shower  
System

## Floorcoverings

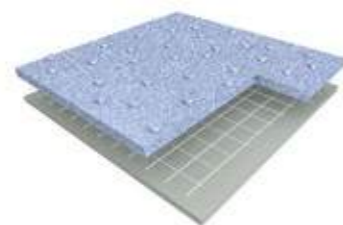

Tarasafe H<sub>2</sub>O

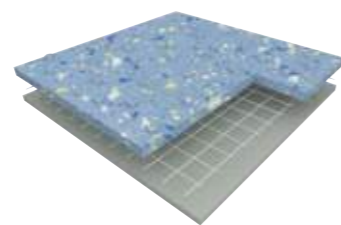

Tarasafe Ultra H<sub>2</sub>O

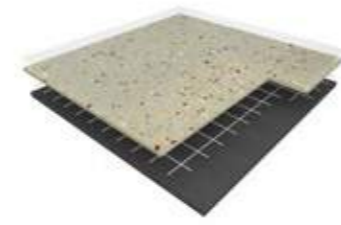

Tarasafe  
Standard / Ultra / Design

## Wallcoverings

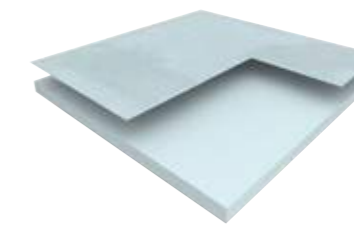

Mural Calypso

Technical  
Solutions



# Technical solutions

## EL5 / EL7 Solutions

### Dissipative floors

#### Mipolam EL7 - Mipolam Robust EL7

##### Mipolam EL7

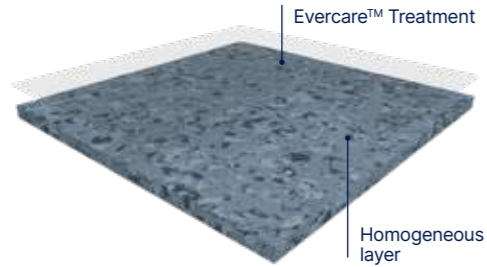

$10^6 \leq Rt \leq 10^8 \Omega$  Evercare™ 100% recyclable

**MIPOLAM EL7** is a dissipative flexible homogeneous vinyl floorcovering available in both sheet and tile form, calendered and compacted and comes in 10 colours. This floorcovering is treated with **EVERCARE™**: the latest improvements in polyurethane surface treatment obtained by UV laser cross-linking. Evercare™ avoids stain of chemical products used in healthcare like Betadine, eosin or anti-bacterial hand gel and increases the durability of the flooring. According to ISO 21702, **MIPOLAM EL7** has **anti-viral activity** against Human Coronaviruses: it reduces the number of virus by 99.7% after 2h. According to ISO 22196, **MIPOLAM EL7** has **anti-bacterial activity** against E. coli, S. aureus and MRSA of 99% after 24h. This treatment has excellent maintenance characteristics; it requires no wax for life! **MIPOLAM EL7** acts as a continuous dissipater  $10^6 \leq Rt \leq 10^8$ . The product has to be grounded with an ESD copper strip (see finishes) to meet its full performance. The product is non-reactive to residual indentation with a value  $\leq 0.02$  mm. The flooring has a binder content type II, is suitable for heavy duty traffic areas and has a Bfl-s1 fire resistance. The product is non-emissive of volatile organic compounds with  $< 10$  microgram/m<sup>3</sup> (TVOC after 28 days ISO 16000-6).

##### Mipolam Robust EL7

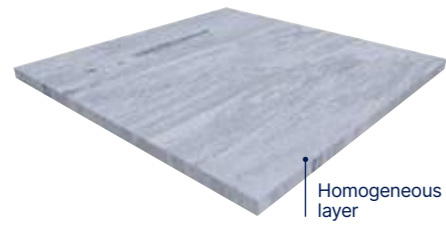

$10^6 \leq Rt \leq 10^8 \Omega$  100% recyclable

**MIPOLAM ROBUST EL7** is a dissipative flexible homogeneous vinyl floorcovering available in both sheet and tile. Calendered and compacted. It acts as a continuous dissipater  $10^6 \leq Rt \leq 10^8$  (EN 1081).

### Conductive floors

#### Mipolam EL5 - Mipolam Technic EL5

##### Mipolam EL5

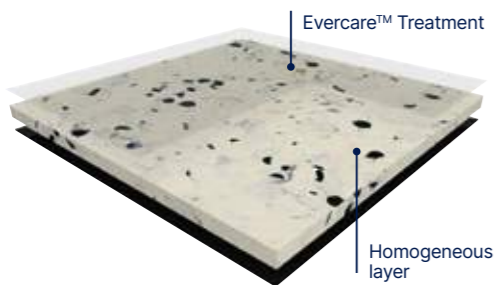

$10^4 \leq Rt \leq 10^8 \Omega$  Evercare™ 100% recyclable

**MIPOLAM EL5** is a conductive flexible homogeneous vinyl floorcovering available in sheet. The 2 mm homogeneous material incorporates carbon encapsulated granules throughout its full thickness. It has a **conductive backing** to ensure optimal and consistent conductive properties throughout its full life expectancy. This floorcovering is treated with **EVERCARE™**: the latest improvements in polyurethane surface treatment obtained by UV laser cross-linking. Evercare™ avoids stain of chemical products used in healthcare like Betadine, eosin or anti-bacterial hand gel and increases the durability of the flooring. According to ISO 21702, **MIPOLAM EL5** has **anti-viral activity** against Human Coronaviruses: it reduces the number of virus by 99.7% after 2h. According to ISO 22196, **MIPOLAM EL5** has **anti-bacterial activity** against E. coli, S. aureus and MRSA of 99% after 24h. This treatment has excellent maintenance characteristics; it requires no wax for life! **MIPOLAM EL5** acts as a continuous conductive  $10^4 \leq Rt \leq 10^8$ . The product has to be grounded with an ESD copper strip (see finishes) to meet its full performance. The product is non-reactive to residual indentation with a value  $\leq 0.02$  mm (EN ISO 24343-1). The flooring complies with the EN ISO 10874 (34-43) offering a binder content type II, is suitable for heavy duty traffic areas and has a Bfl-s1 fire resistance. The product is non-emissive of volatile organic compounds with  $< 10$  microgram/m<sup>3</sup> (TVOC after 28 days ISO 16000-6).

##### Mipolam Technic EL5

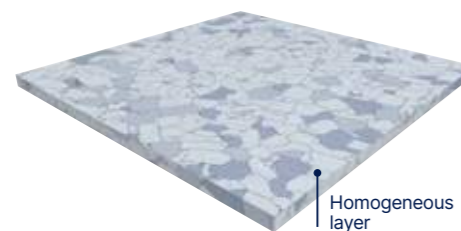

$10^4 \leq Rt \leq 10^8 \Omega$  100% recyclable

**MIPOLAM TECHNIC EL5** is a conductive flexible homogeneous compacted vinyl floorcovering available in tiles. The conductive carbon coated PVC pellets create a perfect conductive network for permanent conductive and antistatic properties throughout its full life expectancy. It acts as a continuous conductive  $10^4 \leq Rt \leq 10^6$  (EN 1081).

100% recyclable

A complete range for Hi-tech applications: electronics and telecommunication areas, computer rooms, operating theatres, radiology...

- Compacted floorcovering for better hygiene, maintenance, and traffic resistance.
- Available in tiles and sheets with specific formats especially adapted to raised floors (608 × 608 mm).

	Mipolam EL7	Mipolam Robust EL7	Mipolam EL5	Mipolam Technic EL5
<b>Description</b>				
Total thickness	EN ISO 24346	mm	2	2
Weight	EN ISO 23997	g/sqm	3100	3300
Width of sheet	EN ISO 24341	cm	200	200
Length of sheet	EN ISO 24341	lm	20	20
Tile size	EN ISO 24342	mm	608 × 608	608 × 608
Number of tiles per package	-	-	20	20
<b>Classification</b>				
Norm / Product specification	-	-	EN ISO 10581	EN ISO 10581
European classification	EN ISO 10874	class	34-43	34-43
Fire rating	EN 13501-1	class	Bfl-s1	Bfl-s1
Electrical resistance <sup>(1)</sup>	EN 1081	Ohm	$10^6 \leq Rt \leq 10^8$	$10^6 \leq Rt \leq 10^8$
Static electrical propensity	EN 1815	kV	< 2	< 2
Slip resistance wet	EN 16165:2021 – Appendix B (DIN 51 130)	class	R9	R9
<b>Performances</b>				
Type Binder content	EN ISO 10581	type	II	II
Dimensional stability	EN ISO 23999	%	Sheet $\leq 0.40$ Tile $\leq 0.25$	Sheet $\leq 0.40$ Tile $\leq 0.25$
Residual indentation (norm)	EN ISO 24343-1		$\leq 0.10$	$\leq 0.10$
Residual indentation (average measured value)	EN ISO 24343-1	mm	$\approx 0.02$	$\approx 0.03$
Castor chair test (type W)	ISO 4918	-	OK	OK
Thermal conductivity	EN ISO 10456	W/(m.k)	0.25	0.25
Colour fastness	EN ISO 105-B02	degree	$\geq 6$	$\geq 6$
Surface treatment	-	-	Evercare™	Evercare™
Chemical products resistance <sup>(2)</sup>	EN ISO 26987	-	OK	OK
Anti-bacterial activity (E.coli – S. aureus – MRSA) after 24h <sup>(3)</sup>	ISO 22196	-	> 99% inhibits growth	> 99% inhibits growth
Anti-viral activity (human coronavirus) after 2h <sup>(3)</sup>	ISO 21702	-	> 99.7% virucidal activity	> 99.7% virucidal activity
<b>Environment / indoor air quality</b>				
TVOC after 28 days	ISO 16000-6	microgram/m <sup>3</sup>	< 10	< 10
Certification	-	-	Floorscore®	Floorscore®
<b>CE marking</b>				
	EN 14041			

(1) Measured before installation.

(2) Staining table available upon request.

(3) The implementation of an effective cleaning method is the best defence against infection

**Important:** please refer to Gerflor installation guidelines - [www.gerflor.com](http://www.gerflor.com)



# Technical solutions

Dissipative floors: Mipolam EL7 & Mipolam Robust EL7

## Mipolam EL7



$10^6 \leq Rt \leq 10^8 \Omega$  Evercare™ 100% recyclable



4120 Silver Grey



4166 Thistle



4159 Grey Storm



4101 Quartz



4120 Silver Grey



4116 Sapphire



4111 Raffia

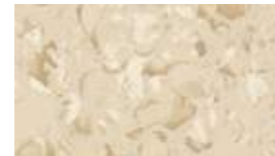

4124 Smoked Opal

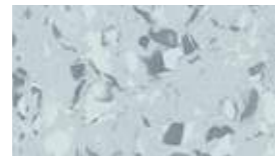

4110 Violet Grey



4144 Havana Brown



4132 Citrine

## Mipolam Robust EL7



$10^6 \leq Rt \leq 10^8 \Omega$  100% recyclable



0003 Ivory



0005 Steel



0013 Pewter



0003 Ivory



0112 Storm



0306 Green



0002 Platinum

Conductive floors: Mipolam EL5 / Technic EL5 / GTI EL5

## Mipolam EL5



$10^4 \leq Rt \leq 10^8 \Omega$  Evercare™ 100% recyclable



0354 Blue

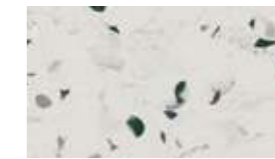

0350 Light Grey

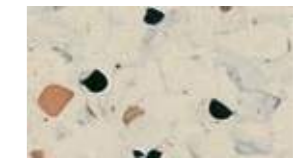

0353 Beige



0354 Blue



0352 Grey



0351 Black



0355 Green

## Mipolam Technic EL5



$10^4 \leq Rt \leq 10^8 \Omega$  100% recyclable



0637 Light Blue



0635 White



0636 Grey



0637 Light Blue



0640 Beige



0638 Blue

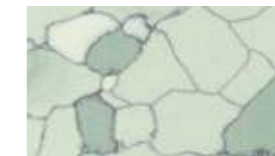

0639 Green

## GTI® EL5

GTI® EL5 (See page 264)



Removable R9 Evercare™ 100% recyclable



# Technical solutions

## Safety Floorings - Tarasafe



### Tarasafe Ultra: Sparclean® Treated **New**

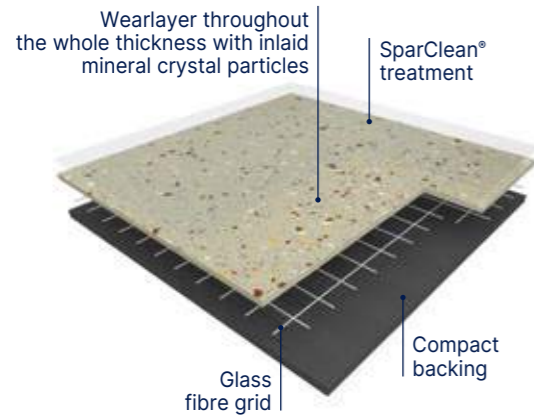

**TARASAFE ULTRA** is a hardwearing safety flooring collection that comprises of a PVC wear layer and deeply inlaid mineral crystal particles (patented) and coloured chips for a decorative design. It is suitable for heavy traffic areas and is ideal for hardworking contract applications. It delivers Safety in Numbers, with a PTV >36+ slip resistance (Dry & Wet), a R10 wet slip resistance rating and >20 Rtm/Rz surface roughness in accordance with HSE guidelines. The revolutionary **SparClean®** surface treatment improves the product performance in terms of stain resistance and durability. It contains 29% recycled content.

### Tarasafe Ultra H<sub>2</sub>O **New**

See page 293

### Tarasafe Standard: Sparclean® Treated **New**

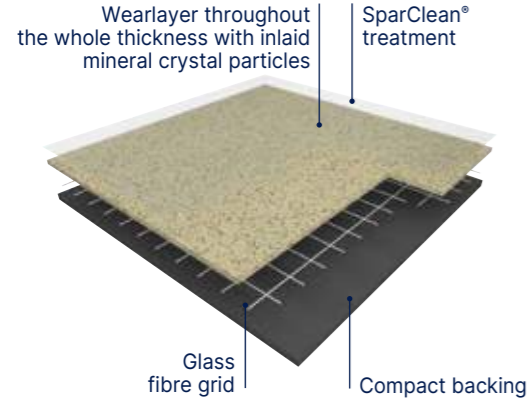

**Tarasafe Standard** is a hardwearing safety flooring collection that comprises of a PVC wear layer and deeply inlaid mineral crystal particles (patented). It is suitable for heavy traffic areas and is ideal for hardworking contract applications. It delivers Safety in Numbers, with a PTV >36+ slip resistance (Dry & Wet), a R10 wet slip resistance rating and >20 Rtm/Rz surface roughness in accordance with HSE guidelines. The revolutionary **SparClean®** surface treatment improves the product performance in terms of stain resistance and durability. It contains 29% recycled content.

### Tarasafe Plus / Tarasafe Super: Non-Treated

#### Tarasafe Super

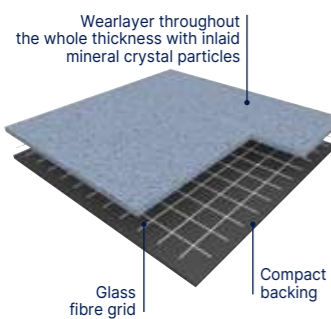

#### Tarasafe Plus

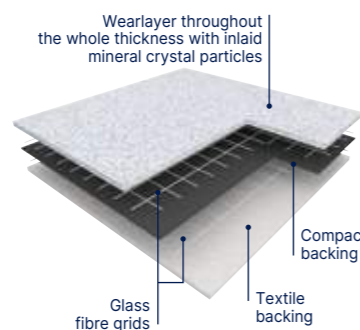

**TARASAFE PLUS** and **TARASAFE SUPER** are slip resistant safety vinyl floorcoverings, wearlayer throughout the whole thickness and deeply inlaid mineral crystal particles (patented). They are reinforced by a glass fibre grid and available in a sheet format. They are an ideal solution for heavy traffic applications where slip resistance, durability, hygiene and easy maintenance are required. **TARASAFE PLUS** comprises a textile backing for better adherence in wet areas. It helps reducing telegraphing. **TARASAFE SUPER** and **PLUS** are suitable for most contract & commercial areas. They are 100% recyclable, Floorscore® certified and do not contain any heavy metals or CMR 1&2, they are also 100% compliant with REACH. The product emission rate of volatile organic compounds is < 100 microgram/m<sup>3</sup> (TVOC after 28 days – ISO 16000 -6).

- **Easy to clean and maintain:** due to a compacted non porous surface made of vinyl content
- **Permanent slip resistance:** dense concentration of deep inlaid mineral crystal particles throughout the wear layer
- **Enhanced colour, design and brightness:** due to the mineral crystal particles
- **Highest abrasion rating**
- **Indoor Air Quality:** low VOC emission

Description	Tarasafe					
	Ultra	Standard	Super	Plus		
<b>Description</b>						
Total thickness	EN ISO 24346	mm	2.0	2.0	2.2	2.5
Thickness of wearlayer	EN ISO 24340	mm	0.85	0.85	1.12	1.14
Weight	EN ISO 23997	g/sqm	2360	2360	2880	3090
Width/Length of sheet	EN ISO 24341	cm/ml	200/20	200/20	200/20	200/20
<b>Classification</b>						
Norm/Product specification	-	-	EN ISO 10582		EN ISO 10582	
European classification	EN ISO 10874	class	34-43	34-43	34-43	
Fire rating	EN 13501-1	class	Bfl-s1	Bfl-s1	Bfl-s1	
Static electrical propensity	EN 1815	kV	≤ 2	≤ 2	< 2	
Slip resistance: Pendulum Test (dry & wet)	EN 16165:2021 – Appendix C (BS 7976-2)	PTV	> 36	> 36	-	
Surface roughness Rz	-	µm	Rz ≥ 20	Rz ≥ 20	-	
Slip resistance wet: Ramp test with oil	EN 16165:2021 – Appendix B (DIN 51 130)	class	R10	R10	R12	R10
Slip resistance wet: Ramp test with water	EN 16165:2021 – Appendix A (DIN 51097)	class	B	B	-	
Slip resistance : Ramp test	EN 13845 (annex C)	class	ESf / ESb	ESf / ESb	-	
<b>Performances</b>						
Wear resistance	EN 660.2	mm <sup>3</sup>	≤2	≤2	≤2	
Wear Group	-	group	T	T	-	
Type Binder content	EN ISO 10582	type	I	I	I	
Dimensional stability	EN ISO 23999	%	≤ 0.40	≤ 0.40	≤ 0.40	
Residual indentation: exigency	EN ISO 24343-1	mm	≤ 0.10	≤ 0.10	≤ 0.10	
Residual indentation (average measure)	-	mm	≤ 0.03	≤ 0.05	≈ 0.03	
Castor chair test (type W)	ISO 4918	-	OK	OK	OK	
Thermal conductivity	EN ISO 10456	W/(m.K)	0.25	0.25	0.25	
Colour fastness	EN ISO 105-B02	degree	≥ 6	≥ 6	≥ 6	
Surface treatment	-	-	SparClean®	SparClean®	-	
Chemical products resistance	EN ISO 26987	-	OK	OK	OK	
Anti-bacterial activity (MRSA) <sup>(1)</sup>	ISO 22196	-	> 99% inhibits growth	> 99% inhibits growth	-	
<b>Environment / indoor air quality</b>						
TVOC after 28 days	ISO 16000-6	microgram/m <sup>3</sup>	< 100	< 100	< 100	
Certification	-	-	Floorscore®	Floorscore®	Floorscore®	
<b>CE marking</b>						
CE	EN 14041					

(1) The implementation of an effective cleaning regime is the most important defence against infection.



# Technical solutions

## Tarasafe Ultra Sparclean® **New**

Compact 2 m R10 SparClean®

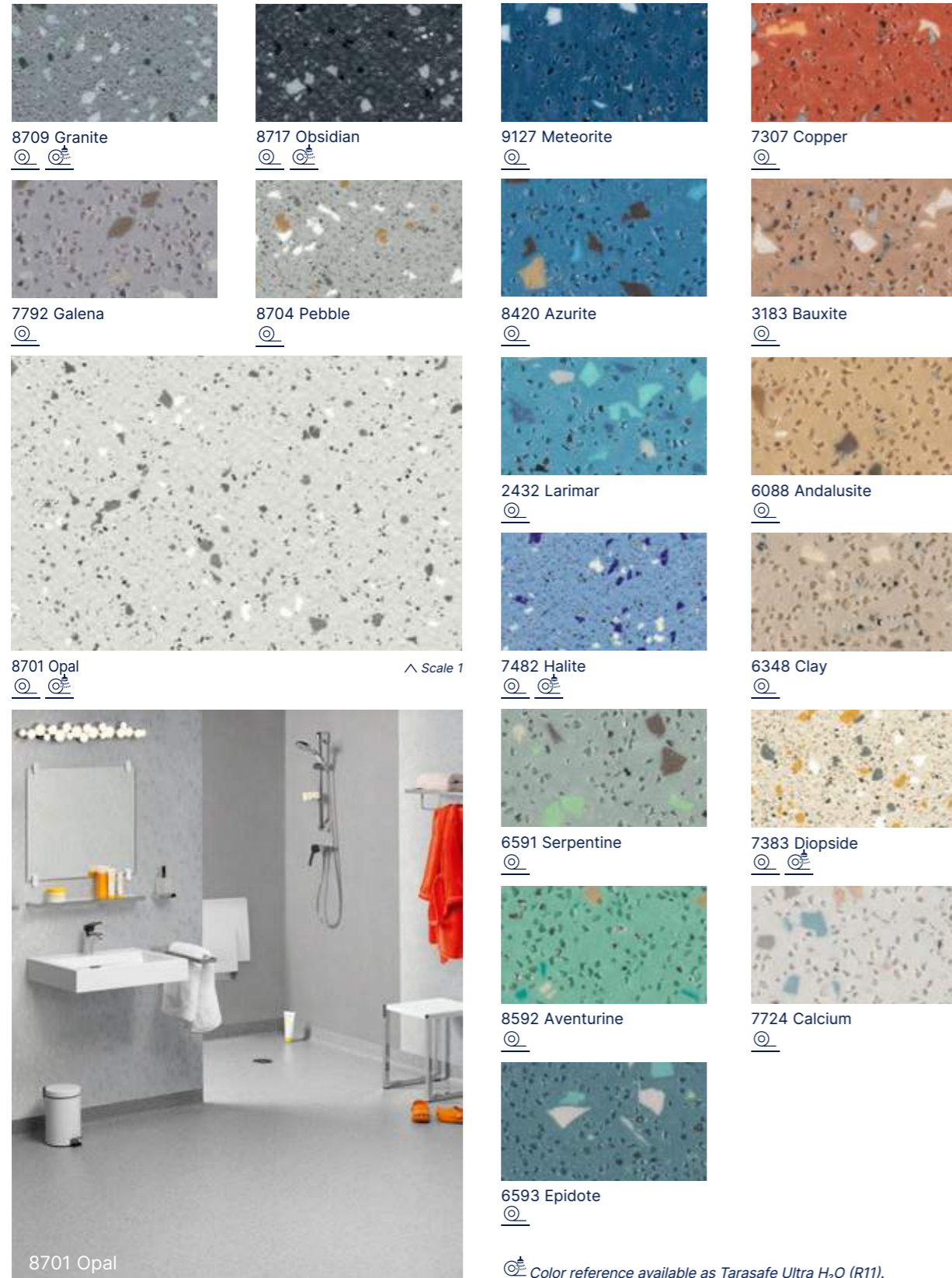

## Tarasafe Standard **New** - Plus - Super

Tarasafe Standard  
Compact 2 m R10 SparClean®

Tarasafe Plus  
Compact 2.5mm 2 m R10  
Textile Backing

Tarasafe Super  
Compact 2 m R12

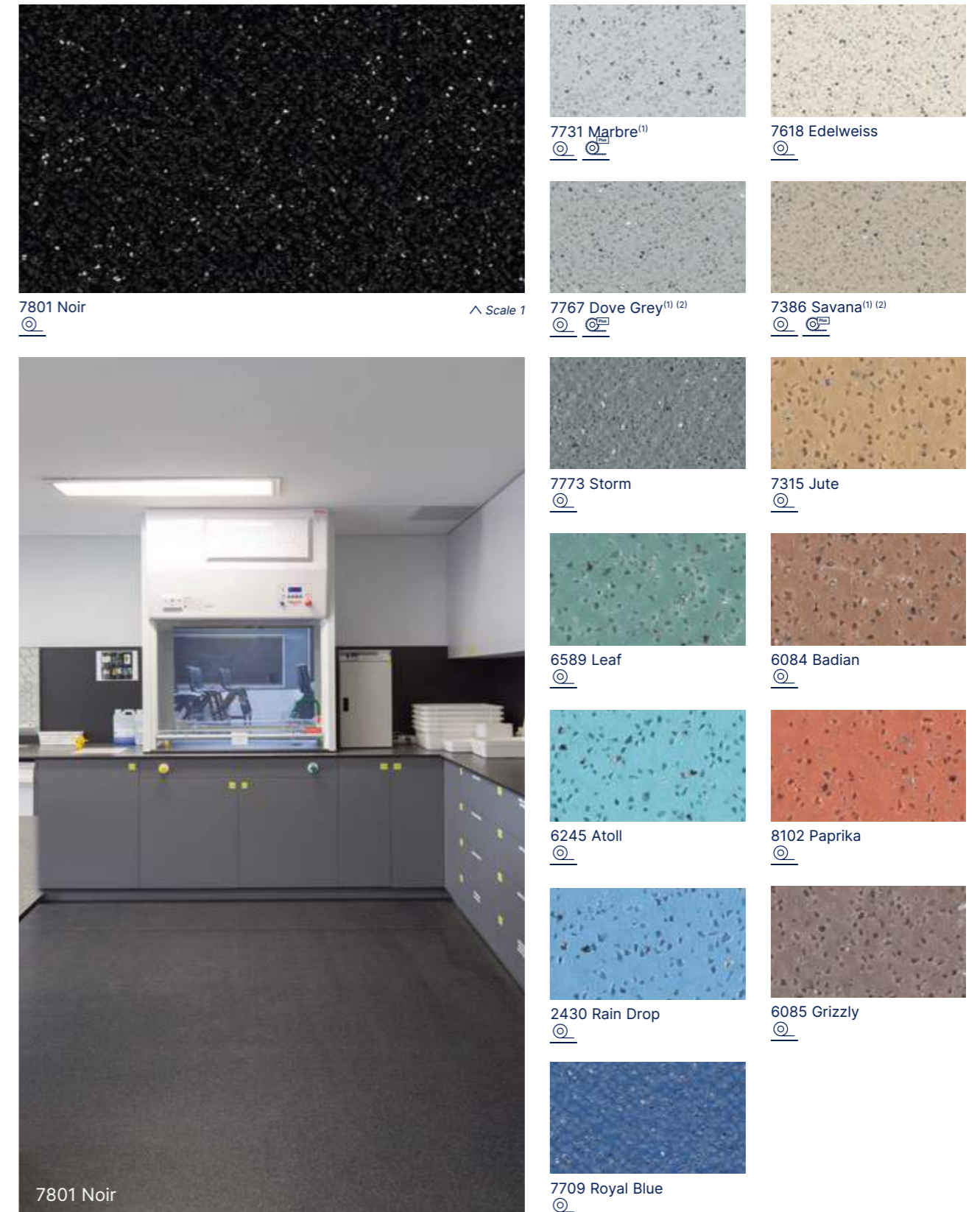



# Technical solutions

## Shower System

### Tarasafe H2O New

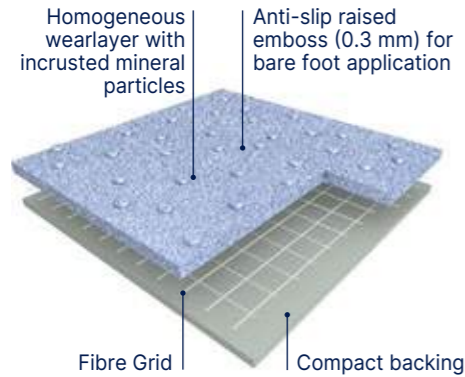

**TARASAFE H2O** is a hardwearing safety flooring collection that comprises of a PVC wear layer containing deeply inlaid mineral particles and coloured elements for a subtle and soft design. It is an ideal solution for those areas where enhanced slip resistance is required for both barefoot and shod use, such as showers, wet rooms, bathrooms, & changing areas. The specific embossing, together with the mineral particles, delivers a Class B barefoot slip resistance rating (according to EN 16165:2021-A and AS 4586-C) and R11 shod slip resistance rating (according to EN 16165: 2021-B and AS 4586-D). It delivers Safety in Numbers, with a PTV >50 slip resistance (Dry & Wet), a R11 wet slip resistance rating and >20 Rtm/Rz surface roughness in accordance with HSE guidelines. The revolutionary SparClean® surface treatment improves the product performance in terms of stain resistance and durability. It is reinforced with a glass fibre grid in sheet form for improved durability and is 100% recyclable. It contains 29% recycled content.

### Tarasafe Ultra H2O

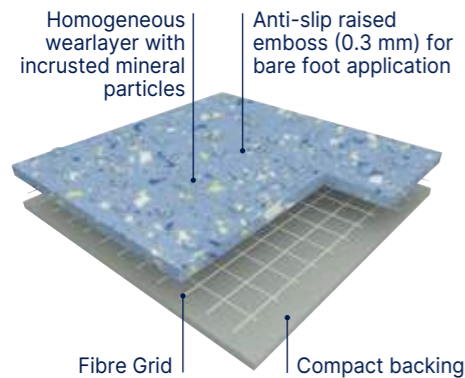

**TARASAFE ULTRA H2O** is a slip resistant vinyl floorcovering, wearlayer throughout the whole thickness and deeply inlaid mineral particles and coloured chips for a decorative design together with a raised emboss for better slip resistance. **TARASAFE ULTRA H2O** is an ideal solution for traffic applications where enhanced slip resistance with barefoot and durability are required such as wet areas. The specific embossing together with the mineral particles give a Class C barefoot slip resistance (DIN 51 097) and R11 slip resistance (DIN 51 130) which makes **TARASAFE ULTRA H2O** ideal for barefoot or shod applications. It is reinforced with a glass fibre grid in sheet form. Its homogeneous wear layer provides a group P of abrasion. According to ISO 22196, **TARASAFE ULTRA H2O** has **anti-bacterial activity** against MRSA of 99% after 24h. It does not contain any heavy metals or CMR 1&2 and it is 100% compliant with REACH. The product emission rate of volatile organic compounds is < 100 microgram/m<sup>3</sup> (TVOC after 28 days – ISO 16000 -6). This product is 100% recyclable and contains 39% recycled content.

### Tarasafe Design

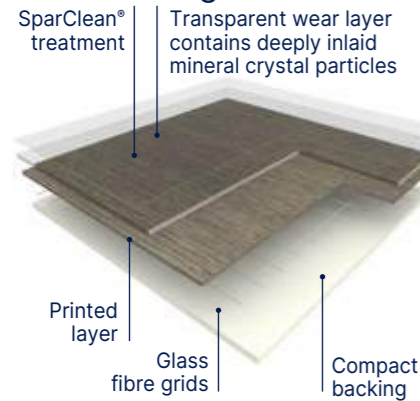

**TARASAFE COMPACT DESIGN** is a slip resistant vinyl floorcovering in sheet, which transparent wear layer contains deeply inlaid mineral crystal particles for durable shod (R10 according to DIN 51130) and barefoot (B according to DIN 51097) antislip performances. It is available in 6 realistic wood or mineral designs thank to a printed layer. It is reinforced with a glass fibre grid and treated with SparClean® surface treatment, a low maintenance cost effective solution providing extreme resistance from soiling and staining. According to ISO 22196, it has an **anti-bacterial activity** against MRSA of 99% after 24 hours. It is an ideal solution for applications where enhanced slip resistance, durability, hygiene and easy maintenance are required – such as for instance showers, changing rooms, sanitation facilities, laboratories... It does not contain any heavy metals or CMR 1&2 and are 100% compliant with REACH. The product emission rate of volatile organic compounds is < 100 microgram/m<sup>3</sup> (TVOC after 28 days – ISO 16000-6). It is 100% recyclable.

### Mural Calypso New

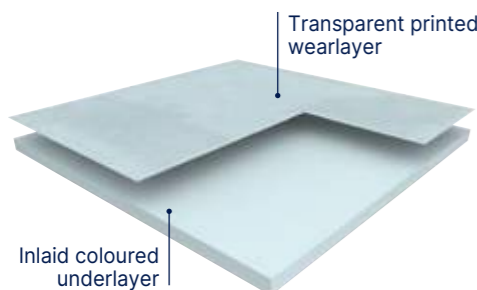

**MURAL CALYPSO** is a multilayered wall covering in 2 m width roll and with a **B-s2,d0 fire classification** according to EN 13501. It is hot welded with CR40 welding rods for a perfect water tightness. It is made of a printed transparent wear layer and a coloured under layer for a better aspect of the welding. This layer comprises up to 30% of recycled products. According to ISO 22196, **MURAL CALYPSO** has **anti-bacterial activity** against E. coli, S. aureus and MRSA of 99% after 24h. It does not contain any CMR 1 & 2 component and is 100% compliant with REACH. It is 100% recyclable. This wall covering is specially recommended for wet room areas and makes the installation in angles easier thanks to its flexibility. The Shower System is compliant with most laws on "access for all" thanks to the installation in shower without tray.

## Tarasafe H2O / Tarasafe Ultra H2O / Tarasafe Design / Mural Calypso



The SHOWER SYSTEM provides a safe and hygienic solution thanks to:

- Anti-slip resistance floorings
- 100% waterproof installation

			Tarasafe H2O	Tarasafe Ultra H2O	Tarasafe Design	Mural Calypso
<b>Description</b>						
Total thickness	EN ISO 24346	mm	2.00	2.0 (on grainside)	2.0	0.92
Thickness of wearlayer	EN ISO 24340	mm	0.85	1.0	0.80	0.10
Weight	EN ISO 23997	g/sqm	2350	2400	2500	1610
Width/Length of sheet	EN ISO 24341	cm/ml	200/20	200/20	200/20	200/30
<b>Classification</b>						
Product specification	-	-	EN ISO 10582	EN ISO 10582	EN ISO 10582	EN 259-1
European classification	EN ISO 10874	class	34-43	34-43	34-43	-
Fire rating	EN 13501-1	class	Bfl-s1	Cfl-s1	Bfl-s1	B-s2,d0
Static electrical propensity	EN 1815	kV	≤ 2	≤ 2	< 2	-
Slip resistance - Pendulum Test (dry & wet)	EN 16165:2021 – Appendix C (BS 7976-2)	PTV	> 50	> 36	> 36	-
Surface roughness	-	µm	Rz ≥ 20	Rz ≥ 20	-	-
Slip resistance wet - test with oil	EN 16165:2021 – Appendix B (DIN 51 130)	class	R11	R11	R10	-
Slip resistance wet - bare foot	EN 16165:2021 – Appendix A (DIN 51097)	class	B	C	B	-
Slip resistance - ramp test	EN 13845 (annex C)	class	ESf / ESb	ESb	ESf / ESb	-
Water tightness	EN 13553	-	OK	OK	OK	-
Slip resistance wet - areas	CTE	class	3	3	-	-
<b>Performances</b>						
Wear Resistance	EN 660.2	mm <sup>3</sup>	-	≤ 4	-	-
Wear Group	NF 189	group	-	P	-	-
Type Binder content	ISO 10582	type	I	I	I	-
Dimensional stability	EN ISO 23999	%	≤ 0.40	≤ 0.40	≤ 0.40	-
Residual indentation	EN ISO 24343-1	mm	≤ 0.10	≤ 0.10	≤ 0.10	-
Residual indentation (measure)	-	mm	-	≤ 0.03	≤ 0.03	-
Castor Chair test (type W)	ISO 4918	-	OK	OK	-	-
Thermal conductivity	EN ISO 10456	W/(m.k)	0.25	0.25	0.25	-
Colour fastness	EN ISO 105-B02	degree	≥ 6	≥ 6	≥ 6	≥ 6
Surface treatment	-	-	SparClean®	-	SparClean®	-
Chemical products resistance	EN ISO 26987	-	OK	OK	OK	OK
Anti-bacterial activity <sup>(1)</sup> (E. coli - S. aureus - MRSA)	ISO 22196	-	> 99% <sup>(2)</sup> inhibits growth	> 99% <sup>(2)</sup> inhibits growth	> 99% <sup>(2)</sup> inhibits growth	> 99% <sup>(3)</sup> inhibits growth
<b>Environment / indoor air quality</b>						
TVOC after 28 days	ISO 16000-6	microgram/m <sup>3</sup>	< 100	< 100	< 100	< 100
Certification	-	-	Floorscore®	Floorscore®	Floorscore®	-
<b>CE marking</b>						
	EN 15102		-	-	-	OK
	EN 14041					-
						-

(1) The implementation of an effective cleaning regime is the most important defence against infection.  
 (2) Anti-bacterial activity (MRSA)  
 (3) Anti-bacterial activity (E. coli - S. aureus - MRSA)

**Gerflor also recommends the Tarasafe compact ranges with surface treatments (SparClean®: Ultra, Standard & Design) for the use in wet room areas. See pages 288-289 & 294**



# Technical solutions

## Antislip Floorings - Tarasafe H2O **New**



0036 Lagoa

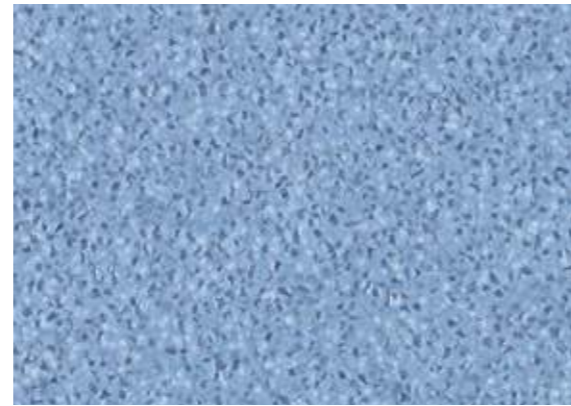

0036 Lagoa ^ Scale 1



0034 Zambezi



0033 Rhine

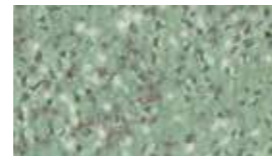

0035 Bacalar



0024 Peyto



0031 Eacham

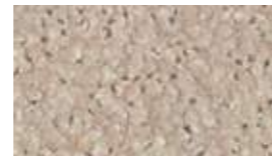

0032 Malawi



0025 Nile



## Antislip Floorings - Tarasafe Ultra H2O



7720 Iceberg

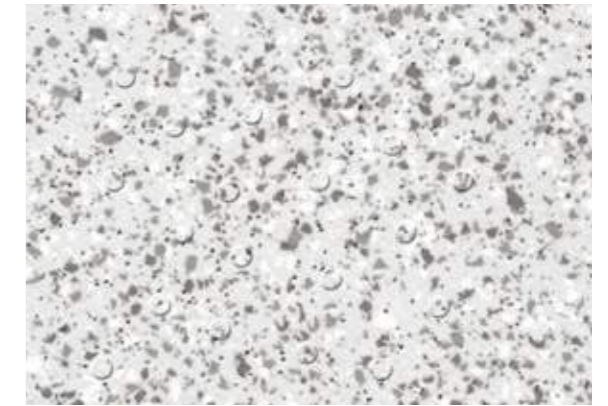

7720 Iceberg ^ Scale 1



7732 Gravel

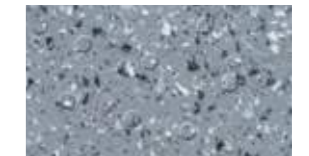

7746 Stone

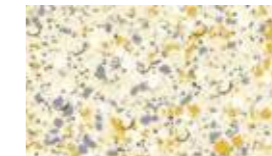

7325 Seashore

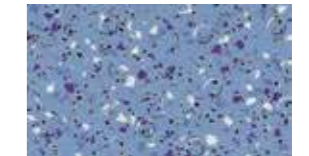

7413 Ocean Blue





# Technical solutions

## Antislip Floorings - Tarasafe Design

  100% recyclable

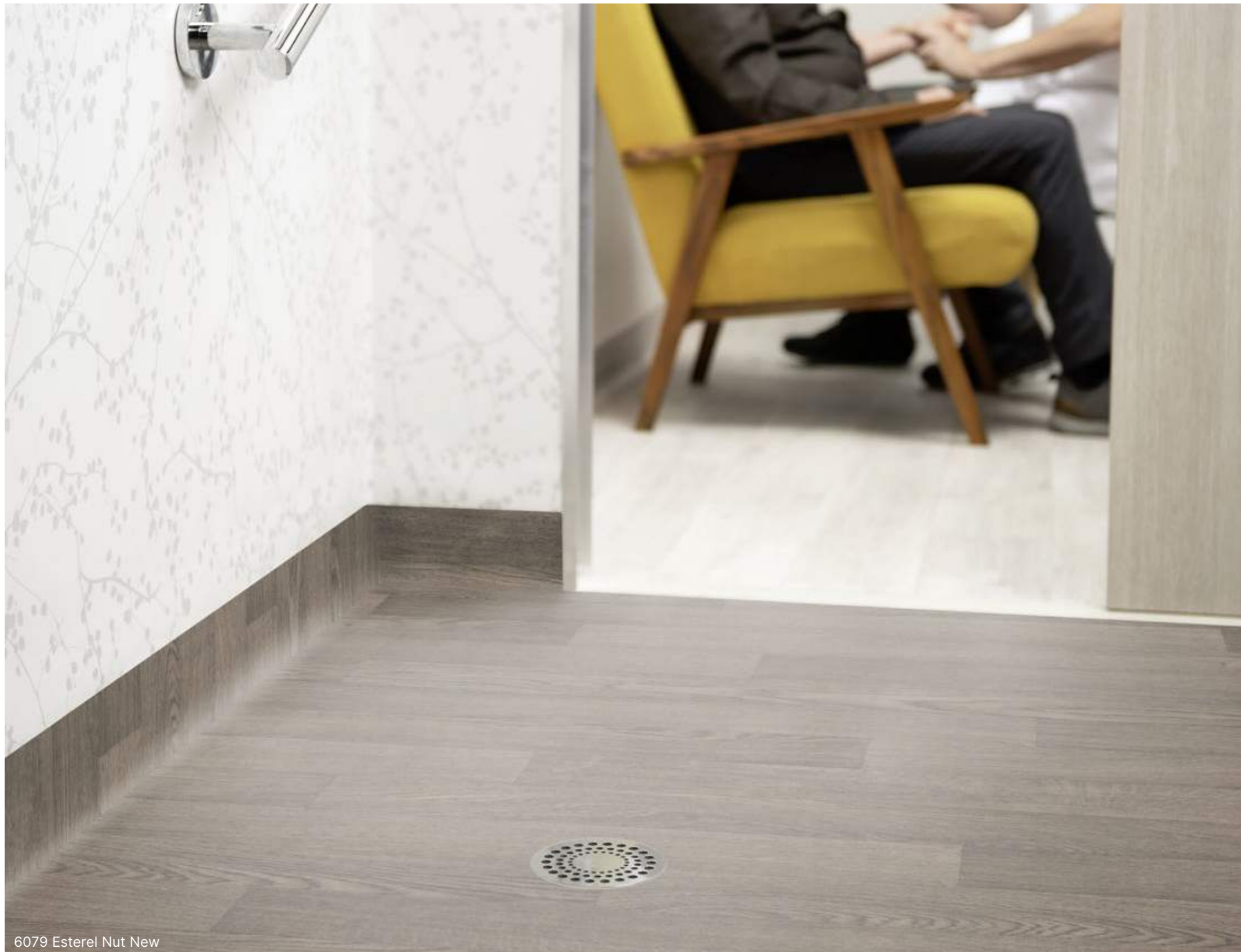

6079 Esterel Nut New

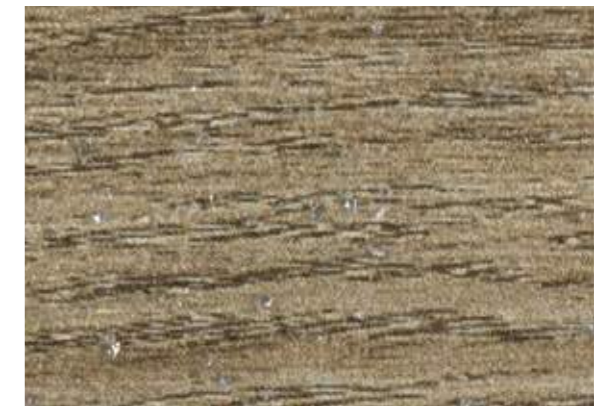

6079 Esterel Nut New

^ Scale 1



6078 Esterel Clear New



6083 Esterel Blossom New



5755 Lorca Natural New



6171 Lofter Dark Grey



6094 Infinity Sand





# Technical solutions

## Mural Calypso **New**



Bs2d0



100% recyclable



7000 Bamboo Snow Pearl\*  
⓪

^ Décor échelle 1



Mural Calypso: Tropic Terra Copper / Uni Snow  
Tarasafe Design: Esterel Clear New



7002 Bamboo Lotus\*\*  
⓪

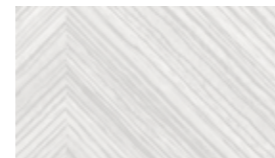

7026 Arty Grey  
⓪

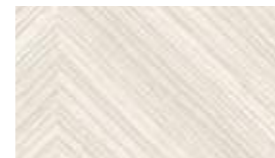

7025 Arty Beige  
⓪



7744 Nordic Milk  
⓪

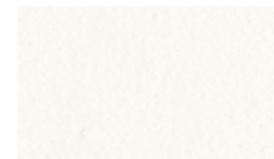

7611 Uni Snow  
⓪



7021 Uni Lotus  
⓪

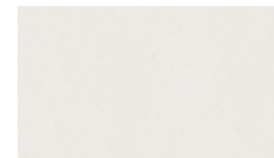

7020 Uni Ice  
⓪



7711 Cloud Ice  
⓪

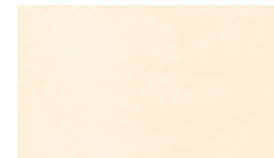

7309 Cloud Lotus  
⓪

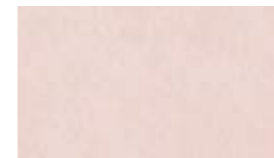

7017 Cloud Pink  
⓪



7014 Ginko Snow Green\*  
⓪



7013 Ginko Snow Gold\*  
⓪



7022 Envol Snow Green\*  
⓪



7023 Envol Snow Skyline\*  
⓪



7016 Tropic Terra Copper  
⓪



7015 Tropic Skyline  
⓪



7018 Cloud Green  
⓪



7311 Cloud Linen  
⓪

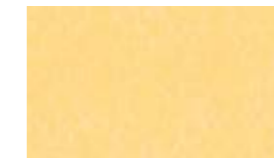

7201 Cloud Moonlight  
⓪



7408 Cloud Skyline  
⓪



7019 Cloud Terra  
⓪



7024 Venice  
⓪



7027 Verona  
⓪



7740 Fabric Silk  
⓪



7721 Manhattan Mist  
⓪



7005 Blossom Snow Pearl\*  
⓪

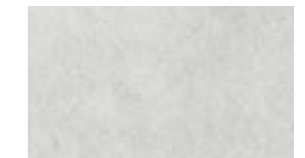

7010 Cloud Haze  
⓪

\*Matching design: 7611 Uni Snow  
\*\*Matching design: 7021 Uni Lotus

More information on accessories (drains, threshold...) on [gerflor.com](http://gerflor.com).



Creative by Nature

# DLW Linoleum

pages 298-327

## 308. Compact Linoleum

- 310. Marmorette
- 314. Colorette
- 315. Uni Walton
- 316. Lino Art

## 320. Acoustic Linoleum

- 322. Marmorette Acoustic
- 322. Marmorette Acoustic Plus
- 323. Colorette Acoustic Plus
- 323. Uni Walton Acoustic Plus
- 323. Lino Art Urban Acoustic Plus

## 324. Technic Linoleum

- 325. Linodur -  
High Mechanical Traffic Resistance
- 325. Marmorette LCH -  
Dissipative Linoleum for ESD areas

### KEY POINTS TO REMEMBER ABOUT GERFLOR DLW LINOLEUM

- 1** The DLW brand stands for **150 years of experience** and has been considered a **reference since its creation**.
- 2** The greenest solution on the market:  
**98% bio based material / 76% rapidly renewable / up to 40% recycled content.**
- 3** **Unlimited possibilities** in terms of **creativity**, allowing unique and **differentiating designs**.
- 4** Adapted to numerous types of buildings, from **education** to **healthcare**, from **public buildings** to **offices**, thanks to a complete portfolio of **compact, acoustic, sport** and **industrial solutions**.



# DLW Linoleum

Creative by Nature



**98%**  
natural

**76%**  
Rapidly renewable

Up to **40%**  
Recycled content

<b>41%</b> Linseed oil	<b>20%</b> Wood flour	<b>19%</b> Limestone
<b>8%</b> Jute	<b>5%</b> Resin	<b>3%</b> Coloured pigments
<b>2%</b> Cork		

To fight climate emergency and natural resources depletion, every choice counts. DLW Linoleum is a 98% natural, low carbon and circular flooring solution.

**we care / we act**

## Sustainable by Nature

### Cradle to Cradle Certified™ SILVER<sup>(1)</sup>

Developed using circular economy principles

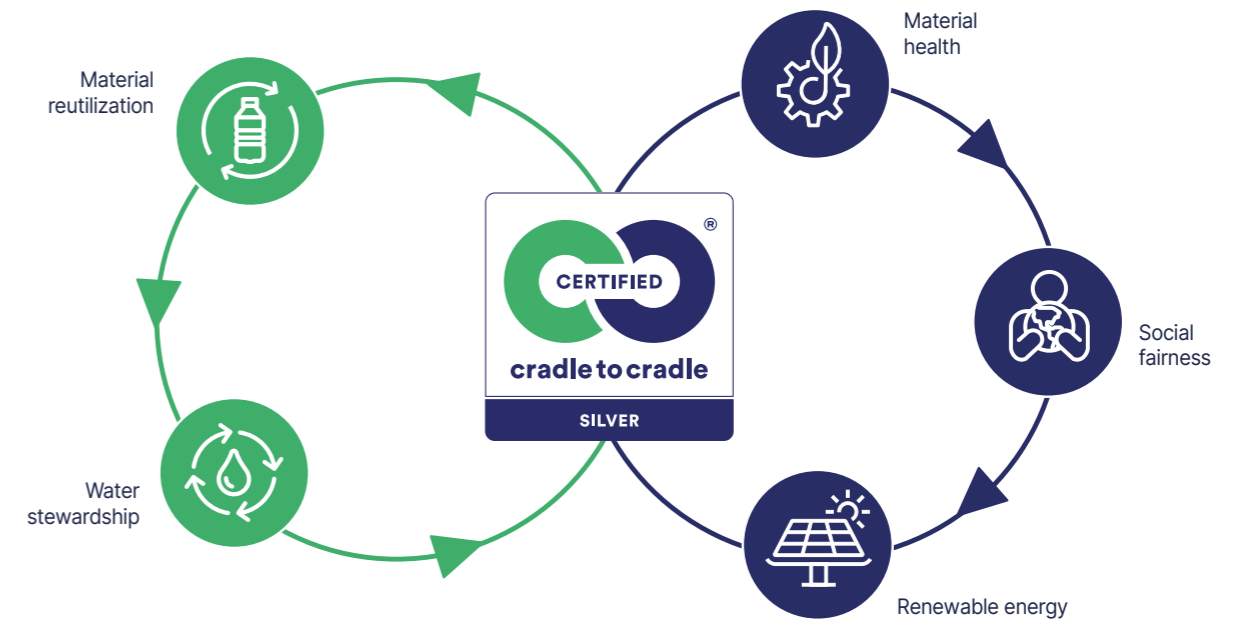

Cradle Certified™ is a registered trademark of the Cradle to Cradle Products Innovation Institute.

### Carbon neutral<sup>(2)</sup>



Third party certified EPD indicates carbon neutrality during the first stages of its life cycle.

### 100 % recyclable



All Gerflor floorings are 100% recyclable and eligible to **Gerflor Second Life collection and recycling program**. Free collection of installation waste is available in 10 countries.

(1) Marmorette, Colorette, Uni Walton, Linodur, Marmorette Acoustic 15dB, Lino Art. / Cradle Certified™ is a registered trademark of the Cradle to Cradle Products Innovation Institute.  
 (2) Cradle to Gate: From Cradle to Gate: includes raw materials and manufacturing process (A1-A3 stages of EPD). Source: Environmental Product Declaration (EPD). Certified by Evea. More information on gerflor.com





# DLW Linoleum

Protective by Nature

**Exclusive**



**New solvent-free surface protection, developed exclusively for linoleum**

Extremely hard-wearing due to triple laser uv cross-linking technology



## Indoor Air Quality

- Very low VOC emissions  
TVOC < 10 microgram/m<sup>3</sup> after 28 days (ISO 16516)
- Certified according to the most demanding standards



## Easy To Clean

- Dirt and stain barrier
- Cost effective maintenance
- Easy cleaning with a mop or any modern cleaning equipment

Detailed cleaning protocol available on [www.gerfor.com](http://www.gerfor.com)



Standard Linoleum



Neocare™



## Hygiene

DLW Linoleum floorings contribute to lower the microbe load (bacteria, virus, ...) and to minimise the risk of a contamination chain.

- Excellent resistance against disinfection chemicals
- Anti-viral and anti-bacterial activity



## Durable

- No sealing and waxing needed
- Higher scratch resistance
- Easy to repair: in case of heavily damaged flooring, DLW linoleum can be easily repaired using the spray buffing method (red disk)

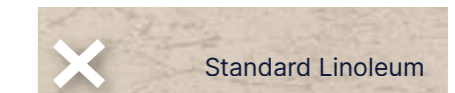

Standard Linoleum



NEOCARE™



## Natural Design

Matt Effect



**WAXING**

Neocare™ is a high performing surface treatment protecting against dirt, stains and scratches and does not require any sealing & waxing throughout the life of the product. Waxing remains an option.



Black disk





# DLW Linoleum

## Mix & Match



Uni Walton  
0100 Ocean Blue



Lino Art Urban  
0566 Shining Blue



Lino Art Urban  
0555 Flashy Street Grey







Marmorette  
0117 Mandarin Orange



Visualize your project  
[interiordesigner.gerflor.com](http://interiordesigner.gerflor.com)



			Marmorette		Colorette / Uni Walton	Lino Art Urban / Metallic / Star	Marmorette Acoustic	Marmorette Acoustic Plus Colorette Acoustic Plus Uni Walton Acoustic Plus Lino Art Urban Acoustic Plus		Linodur	Marmorette LCH
Description			R10	Bfl-s1							
Total thickness	EN ISO 24346	mm	2.0 / 2.5 / 3.2	2.5	2.5	2.5	2.5	4.0	4.0	4.0	2.5
Backing	-	-	Jute fabric		Jute fabric	Jute fabric	Cork and jute fabric backing	Foam backing	Jute fabric	Jute fabric	
Thickness of cork/foam backing	EN ISO 24340	-	-		-	-	2	1.5	-	-	
Weight	EN ISO 23997	g/sqm	2400 / 2900 / 3800	2900	2900	2900	3900	3500	4700	3000	
Width of sheet	EN ISO 24341	cm	200		200	200	200	200*	200	200	
Length of sheet	EN ISO 24341	m	20-31		20-31	20-31	20-31	20-31*	app. 28	20 - 31	
<b>Classification</b>											
Norm/Product specification	-	-	EN ISO 24011		EN ISO 24011	EN ISO 24011	EN 687	EN 686	EN ISO 24011	EN ISO 24011	
European classification	EN ISO 10874	class	23 / 34 / 43 23 / 32 / 41 in 2.0 mm		23 / 34 / 43	23 / 34 / 43	23 / 33 / 41	23 / 33 / 41	23 / 34 / 43	23 / 34 / 43	
Classement UPEC	-	-	-/U4P3E1/2C2		-	U4P3E1/2C2	-	-	-	-	
Fire rating**	EN 13501-1	class	Cfl-s1		Bfl-s1	Cfl-s1	Cfl-s1	Cfl-s1	Cfl-s1	Cfl-s1	
Slip resistance	EN 16165:2021 – Appendix B (DIN 51 130)	class	R9	R10	R9	R9	R9	R9	R10	R9	
Impact sound insulation	EN ISO 717-2	dB	3 dB / 5 dB / 6 dB		5 dB	5 dB	5 dB	15 dB	19 dB	8 dB	3 dB
<b>Performances</b>											
Residual indentation	EN ISO 24343-1	mm	≤ 0.09 / ≤ 0.11	≤ 0.11	≤ 0.11	≤ 0.11	≤ 0.11	≤ 0.40	≤ 0.30	≤ 0.20	≤ 0.15
Colour fastness	EN ISO 105-B02	rating	≥ 6		≥ 6	≥ 6	≥ 6	≥ 6	≥ 6	≥ 6	≥ 6
Vertical resistance	EN 1081	Ohm	-		-	-	-	-	-	-	10 <sup>6</sup> ≤ R ≤ 10 <sup>8</sup>
Point contact resistance	VDE 0100	kOhm	> 200		> 200	> 200	> 200	> 200	> 200	> 200	> 100
Static electrical propensity	EN 1815	kV	≤ 2		≤ 2	≤ 2	≤ 2	≤ 2	≤ 2	≤ 2	≤ 2
Castor chair test (Type W)	ISO 4918	-	OK		OK	OK	OK	OK	OK	OK	OK
Flexibility	ISO 24344	mm	Ø 40 (2.5mm)		Ø 40	Ø 40	Ø 60	Ø 40	Ø 60	Ø 40	
Flexibility / average measured value	ISO 24344	mm	Ø 30 (2.5mm)		Ø 30	Ø 30	Ø 30	Ø 35	Ø 50	Ø 30	
Thermal resistance	EN 12667	(m <sup>2</sup> /K)/W	0.012 / 0.015 / 0.018		0.015	0.015	0.04	0.044	0.023	0.015	
Thermal conductivity	EN ISO 10456	W/(m.K)	0.17		0.17	0.17	0.17	0.0937	0.17	0.17	
Surface treatment	-	-	Neocare™		Neocare™	Neocare™	Neocare™	Neocare™	Neocare™	Neocare™	
Chemical products resistance	EN ISO 26987	-	Excellent		Excellent	Excellent	Excellent	Excellent	Excellent	Excellent	
Anti-bacterial activity (E. coli – S. aureus – MRSA) after 24 h***	EN ISO 22196 / JIS Z 2801	-	> 99.99% inhibits growth		> 99.99% inhibits growth	> 99.99% inhibits growth	> 99.99% inhibits growth	> 99.99% inhibits growth	> 99.99% inhibits growth	> 99.99% inhibits growth	
Anti-viral activity (Human coronavirus) after 5 h***	ISO 21702	-	> 98.65% virucidal activity		> 98.65% virucidal activity	> 98.65% virucidal activity	> 98.65% virucidal activity	> 98.65% virucidal activity	> 98.65% virucidal activity	> 98.65% virucidal activity	
<b>Indoor air quality</b>											
TVOC after 28 days	EN 16516	microgram/m <sup>3</sup>	< 10		< 10	< 10	< 10	< 10	< 50	< 10	
<b>Circular economy</b>											
Certification	Cradle to Cradle	-	Silver		Silver	Silver	Silver	Silver	Bronze	Silver	-
<b>CE marking</b>											
	EN 14041 : 2004 AC : 2006	-	   								

\* Roll dimension for SRP article code: R929/R930/R931/R932/R933/R934/R935: 1,96m x 18-29lm

\*\* Glued according to certificate. DOP numbers available from your local branch.

\*\*\* The implementation of an effective cleaning method is the best defence against infection.

 Depending on light exposure, the product color can vary, due to linoleum natural oxidization process. This process is reversible. We recommend that the samples be exposed to sunlight for several hours prior to making a final color choice.



# Compact Linoleum

Marmorette / Colorette /  
Uni Walton / Lino Art

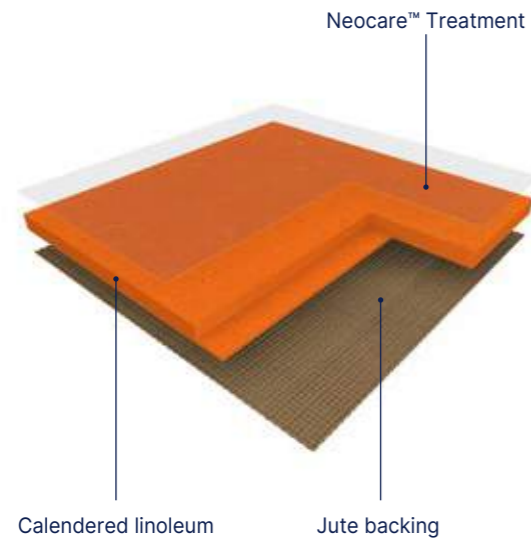

Marmorette / Colorette /  
Uni Walton / Lino Art

**MARMORETTE** is a calendered linoleum compact floorcovering in sheet, 2m wide, providing excellent resistance to everyday wear and tear in high traffic areas. Its weight is 2400g/sqm in 2.0mm, 2900g/sqm in 2.5mm and 3800g/sqm in 3.2mm. It features a marbled design and presents a matt finish, is composed of 98% natural materials (linseed oil, wood flour, resins, minerals and jute fabric) among of which 76% are rapidly renewable.

**COLORETTE** is a calendered linoleum compact floorcovering in sheet, 2m wide, providing excellent resistance to everyday wear and tear in high traffic areas. Its weight is 2900g/sqm in 2.5mm. It features a speckled design and presents a matt finish, is composed of 98% natural materials (linseed oil, wood flour, resins, minerals and jute fabric) among of which 76% are rapidly renewable.

**UNI WALTON** is a calendered linoleum compact floorcovering in sheet, 2m wide, providing excellent resistance to everyday wear and tear in high traffic areas. Its weight is 2900g/sqm in 2.5mm. It features a uni design and presents a matt finish, is composed of 98% natural materials (linseed oil, wood flour, resins, minerals and jute fabric) among of which 76% are rapidly renewable.

**LINO ART** is a calendered linoleum compact floorcovering in sheet, 2m wide, providing excellent resistance to everyday wear and tear in high traffic areas. Its weight is 2900g/sqm in 2.5mm. It features a striated design, a scattered metallic design (METALLIC), a scattered colour chips design (STAR), a concrete design (URBAN) and presents a matt finish, is composed of 98% natural materials (linseed oil, wood flour, resins, minerals and jute fabric) among of which 76% are rapidly renewable.

**COLORETTE, MARMORETTE, UNI WALTON, LINO ART**  
The floorings are produced with Neocare™ solvent-free surface treatment, an exclusive photo-cured acrylate based lacquer surface treatment obtained by triple laser UV cross linking. Neocare™ offers excellent scratch resistance as well as resistance to chemicals found in aggressive environments such as bleach, hydro alcoholic solutions, Betadine and Eosin as well as markers making maintenance easier and increasing the life of the flooring. This treatment avoids performing any polishing throughout the lifetime of the product. It can however be polished following usual recommendations and according to the customer's wishes.

















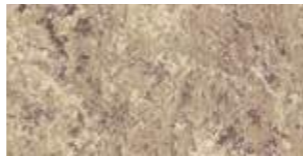



The products ensure perfect indoor air quality (TVOC at 28 days (EN 16516) < 10 microgram/m<sup>3</sup>) and are classified A + (the best class) in the context of health labeling. It is Floorscore®, M1 and Blue Angel certified.  
The floorings are 100% recyclable, are composed of minimum 25% recycled content and up to 40% recycled content, 100% controlled, are REACH compliant and rated Cfl-s1 for fire resistance. Designed and manufactured in a sustainable way in a plant awarded with ISO 9001 (quality), ISO 14001 (environment) and ISO 50001 (energy) certifications, the floorings are Cradle to Cradle certified™ Silver. They are Environmental Performance Declaration (EPD) certified by an external laboratory indicating carbon neutrality during the first stages of their life cycle ("from cradle to gate").  
The Camouflage (Marmorette) or Uni (Colorette, Uni Walton, Lino Art) welding rod makes the connections between the strips invisible. They are antistatic, antibacterial according to ISO 22196 / JIS Z 2801 and antiviral according to ISO 21702.



# Compact Linoleum



















## Marmorette

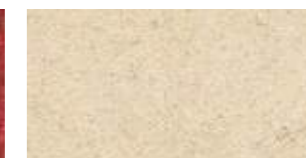

			
0056 Foggy Blue 2.5 mm / 3.2 mm	0253 Pebble Grey 2.5 mm	0252 Light Grey 2.5 mm	0251 Cream 2.5 mm
			
0053 Ice Grey 2.0 mm / 2.5 mm / 3.2 mm	0254 Mineral Grey 2.5 mm	0155 Smoked Pearl 2.5 mm	0106 Hazelnut Shake 2.5 mm
			
0055 Ash Grey 2.0 mm / 2.5 mm / 3.2 mm	0166 Clay 2.5 mm	0091 Shiitake Mushroom 2.5 mm	0146 Beeswax Beige 2.5 mm
			
0054 Concrete Patty 2.5 mm	0158 Tabac Grey 2.5 mm	0153 Greystone Grey 2.5 mm	0090 Soapstone 2.5 mm
			
0160 Industrial Grey 2.0 mm / 2.5 mm	0050 Quartz Grey 2.0 mm / 2.5 mm / 3.2 mm	0164 Milk Coffee 2.5 mm	0003 Dark Brown 2.5 mm
			
0096 Midnight Grey 2.5 mm	0059 Plumb Grey 2.0 mm / 2.5 mm / 3.2 mm	0108 Mokka Brown 2.5 mm	0089 Peacan Pie 2.5 mm

## Marmorette



			
0070 Rocky Brown 2.0 mm / 2.5 mm / 3.2 mm	0092 Beach 2.5 mm	0040 Light Sahara 2.0 mm / 2.5 mm	0042 Shortcrust 2.5 mm
			
0072 Golden Yellow 2.5 mm	0172 Papaya Orange 2.5 mm	0076 Pale Yellow 2.5 mm	0098 Desert Beige 2.5 mm
			
0073 Spicy Orange 2.5 mm	0173 Melon Orange 2.5 mm	0243 Marble Beige 2.5 mm	0045 Sand Beige 2.0 mm / 2.5 mm
			
0117 Mandarin Orange 2.5 mm	0118 Chili Red 2.5 mm	0018 Lobster Red 2.5 mm	0145 Banana White 2.5 mm
			
0119 Terracotta 2.5 mm	0019 Sunset Orange 2.5 mm	0075 Light Aurora 2.5 mm	0211 Pink 2.5 mm

**A** Acoustic 15 dB in stock   **A+** AcousticPlus 19 dB in stock   **R10** R10: in stock   **Bfl** Bfl-s1: in stock

All colours can be manufactured in Acoustic 15 dB version. Special request - Minimum order quantity: 1500 sqm. Below 1500 sqm, use Korkment underlayer.  
All colours can be manufactured in AcousticPlus 19 dB version. Special request - Minimum order quantity: 58 sqm.



# Compact Linoleum

## Marmorette



Neocare™



0130 Antique Green  
2.5 mm



0049 Royal Blue  
2.5 mm / 3.2 mm



0121 Blue Eyes  
2.5 mm



0100 Frog Green  
2.5 mm



0043 Leaf Green  
2.5 mm

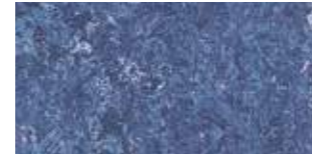

0148 Ink Blue  
2.5 mm



0023 Dusty Blue   
2.0 mm / 2.5 mm / 3.2 mm



0132 Lime Green  
2.5 mm



0099 Grey Turquoise  
2.5 mm



0128 Violet  
2.5 mm



0122 Fluffy Blue  
2.5 mm



0138 Khaki  
2.5 mm



0022 Autumn Blue  
2.5 mm / 3.2 mm



0224 Mystery Blue  
2.5 mm



0026 Sky Blue  
2.5 mm



0083 Jungle  
2.5 mm



0136 Turquoise Bay  
2.5 mm



0149 Dark Blue  
2.5 mm



0028 Dive  
2.5 mm



0129 Curacao Petrol  
2.5 mm

^ Scale 1

Acoustic 15 dB in stock

AcousticPlus 19 dB in stock

R10: in stock

Bfl-s1: in stock

All colours can be manufactured in Acoustic 15 dB version. Special request - Minimum order quantity: 1500 sqm. Below 1500 sqm, use Korkment underlayer.  
All colours can be manufactured in AcousticPlus 19 dB version. Special request - Minimum order quantity: 58 sqm.

0129 Curacao Petrol



# Compact Linoleum

## Colorette

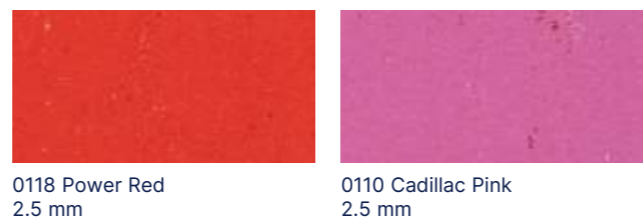
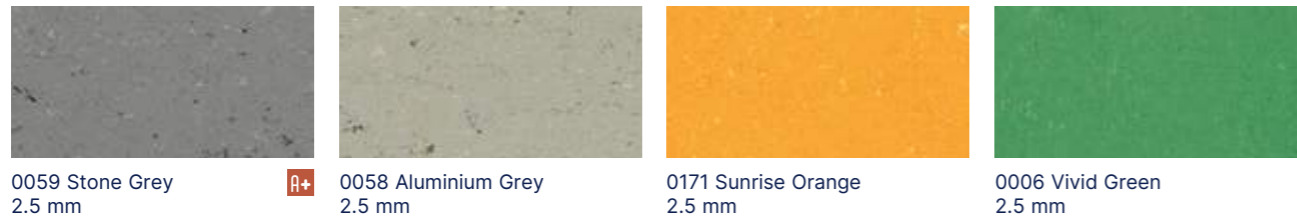

**A+** AcousticPlus 19 dB in stock

All colours can be manufactured in Acoustic 15 dB version. Special request - Minimum order quantity: 1500 sqm. Below 1500 sqm, use Korkment underlayer.  
All colours can be manufactured in AcousticPlus 19 dB version. Special request - Minimum order quantity: 58 sqm.

# Uni Walton

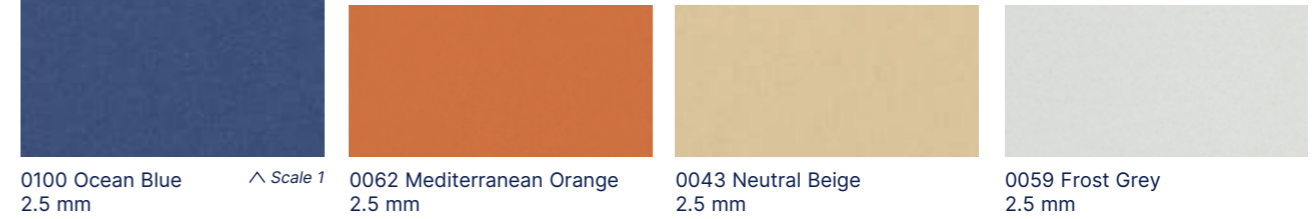
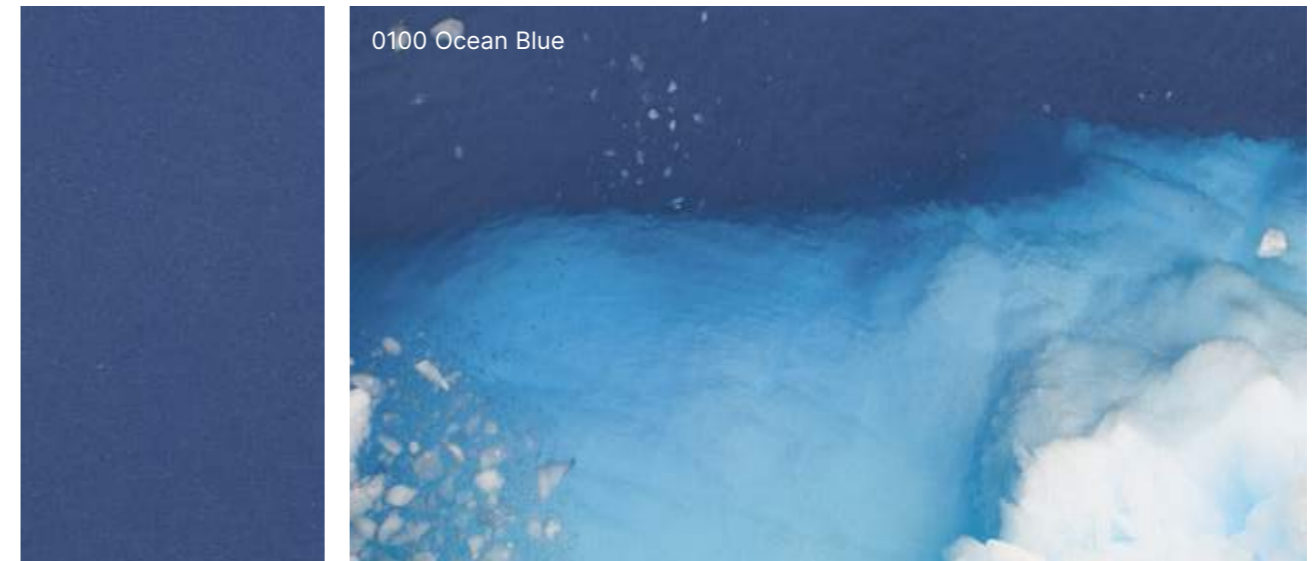

**A+** AcousticPlus 19 dB in stock

All colours can be manufactured in Acoustic 15 dB version. Special request - Minimum order quantity: 1500 sqm. Below 1500 sqm, use Korkment underlayer.  
All colours can be manufactured in AcousticPlus 19 dB version. Special request - Minimum order quantity: 58 sqm.



# Compact Linoleum

## Lino Art - Urban



0554 Concrete Grey



0551 Flashy Asphalt Grey  
2.5 mm

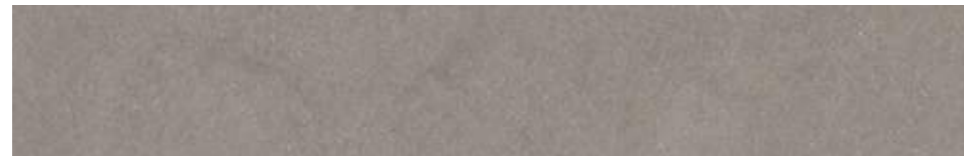

0554 Concrete Grey  
2.5 mm



^ Scale 1



0552 Silver Grey  
2.5 mm

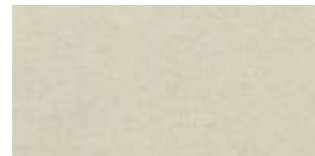

0564 Natural Stone  
2.5 mm



0555 Flashy Street Grey  
2.5 mm



0550 Beton Soft Grey  
2.5 mm



0567 Shining Green  
2.5 mm



0556 Mud Grey  
2.5 mm

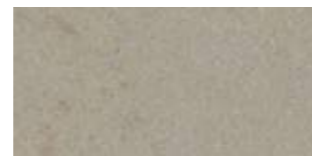

0557 Urban Grey  
2.5 mm



0558 Screed Grey  
2.5 mm



0566 Shining Blue  
2.5 mm



0562 Titan Grey  
2.5 mm



0560 Bold Grey  
2.5 mm

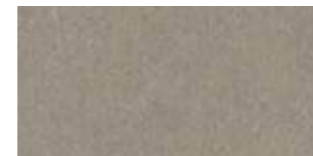

0559 Vintage Grey  
2.5 mm



0565 Graphite Grey  
2.5 mm



0563 Zinc Grey  
2.5 mm



0553 Dark Concrete Grey  
2.5 mm



0561 Pitch Black  
2.5 mm



AcousticPlus 19 dB in stock

All colours can be manufactured in Acoustic 15 dB version. Special request - Minimum order quantity: 1500 sqm. Below 1500 sqm, use Korkment underlayer.  
All colours can be manufactured in AcousticPlus 19 dB version. Special request - Minimum order quantity: 58 sqm.

## Lino Art - Star

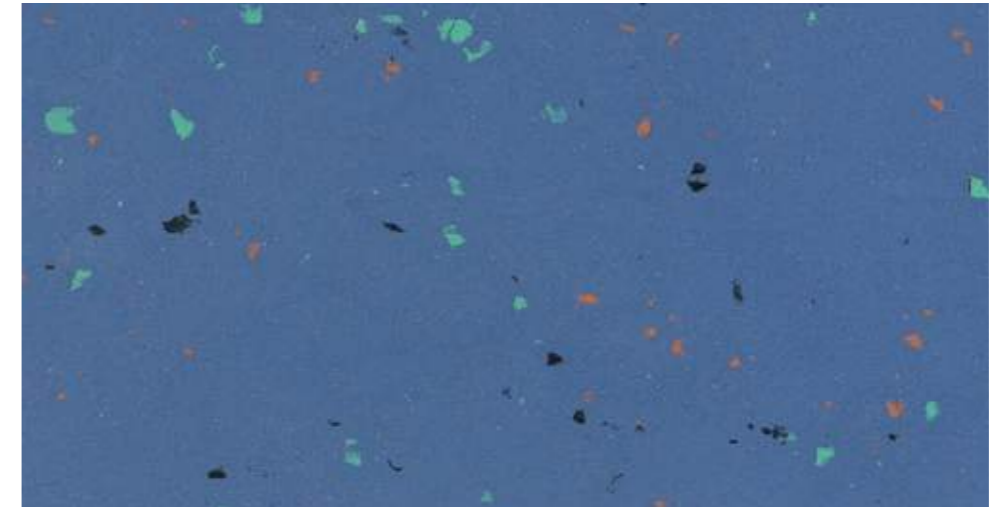

0025 Clear Blue  
2.5 mm

^ Scale 1



0020 Aqua Turquoise  
2.5 mm



0001 Lemon Yellow  
2.5 mm



0092 Stratiatella  
2.5 mm



0030 Apple Green  
2.5 mm



0075 Apricot  
2.5 mm



0059 Dusty Grey  
2.5 mm



0023 Blue Turquoise  
2.5 mm



0015 Glaring Red  
2.5 mm



0090 Smooth Grey  
2.5 mm



0094 Bubble Gum  
2.5 mm



0085 Mid Grey  
2.5 mm



# Compact Linoleum

## Lino Art - Metallic

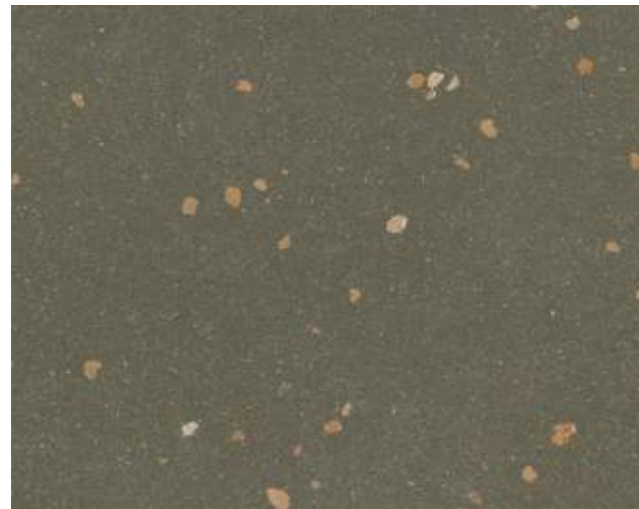

0072 Olive Green  
2.5mm

^ Scale 1



0078 Petrol Blue  
2.5 mm



0070 Cool Grey  
2.5 mm



0083 Aluminio Light Grey  
2.5 mm



0068 Bottle Green  
2.5 mm



0074 Burned Siena  
2.5 mm



0080 Firmament Black  
2.5 mm



0076 Salsa  
2.5 mm



0072 Olive Green



Colorette - 0001 Banana Yellow



# Acoustic Linoleum

## Marmorette Acoustic Plus / Colorette Acoustic Plus

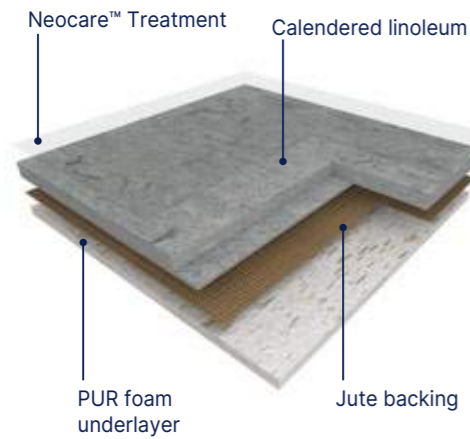

## Marmorette Acoustic

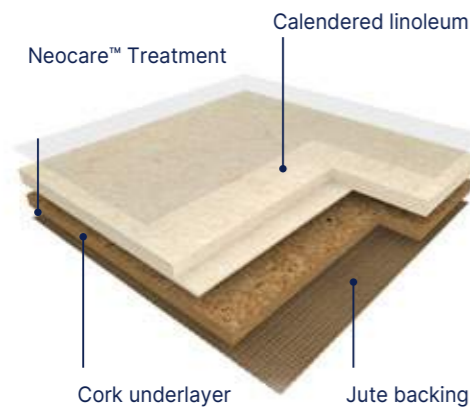

## Korkment: Cork Acoustic Underlayer



2.0 mm underlayer (weight 1.2 kg/sqm)  
15 dB impact sound reduction

Ref R1020102



## Marmorette Acoustic Plus / Colorette Acoustic Plus Uni Walton Acoustic Plus / Lino Art Urban Acoustic Plus

**MARMORETTE ACOUSTIC PLUS** is a calendered linoleum acoustic floorcovering in sheet, 2m wide, providing excellent resistance to everyday wear and tear in high traffic areas. Its weight is 3500g/sqm in 4.0mm. It features a marbled design and presents a matt finish, is composed of natural materials (linseed oil, wood flour, resins, minerals and jute fabric), rapidly renewable and features a 1.5mm recycled foam underlayer, ensuring up to 19dB impact sound reduction.

**COLORETTE ACOUSTIC PLUS** is a calendered linoleum acoustic floorcovering in sheet, 2m wide, providing excellent resistance to everyday wear and tear in high traffic areas. Its weight is 3500g/sqm in 4.0mm. It features a speckled design and presents a matt finish, is composed of natural materials (linseed oil, wood flour, resins, minerals and jute fabric), rapidly renewable and features a 1,5mm recycled foam underlayer, ensuring up to 19dB impact sound reduction.

**UNI WALTON ACOUSTIC PLUS** is a calendered linoleum acoustic floorcovering in sheet, 2m wide, providing excellent resistance to everyday wear and tear in high traffic areas. Its weight is 3500g/sqm in 4.0mm. It features a uni design and presents a matt finish, is composed of natural materials (linseed oil, wood flour, resins, minerals and jute fabric), rapidly renewable and features a 1,5mm recycled foam underlayer, ensuring up to 19dB impact sound reduction.

**LINO ART URBAN ACOUSTIC PLUS** is a calendered linoleum acoustic floorcovering in sheet, 2m wide, providing excellent resistance to everyday wear and tear in high traffic areas. Its weight is 3500g/sqm in 4.0mm. It features a concrete design and presents a matt finish, is composed of natural materials (linseed oil, wood flour, resins, minerals and jute fabric), rapidly renewable and features a 1,5mm recycled foam underlayer, ensuring up to 19dB impact sound reduction.

## Marmorette Acoustic

**MARMORETTE ACOUSTIC** is a calendered linoleum acoustic floorcovering in sheet, 2m wide, providing excellent resistance to everyday wear and tear in high traffic areas. Its weight is 3900g/sqm in 4.0mm. It features a marbled design and presents a matt finish, is composed of natural materials (linseed oil, wood flour, resins, cork, minerals and jute fabric), rapidly renewable and features a 2mm cork underlayer, ensuring up to 15dB impact sound reduction.

## Acoustic Linoleum

The floorings are produced with Neocare™ solvent-free surface treatment, an exclusive photo-cured acrylate based lacquer surface treatment obtained by triple laser UV cross linking. Neocare™ offers excellent scratch resistance as well as resistance to chemicals found in aggressive environments such as bleach, hydro alcoholic solutions, Betadine and Eosin as well as markers making maintenance easier and increasing the life of the flooring. This treatment avoids performing any polishing throughout the lifetime of the product. It can however be polished following usual recommendations and according to the customer's wishes. The products ensure perfect indoor air quality (TVOC at 28 days (EN 16516) < 10 microgram/m<sup>3</sup>) and are classified A + (the best class) in the context of health labeling. They are Floorscore®, M1 and Blue Angel certified. The floorings are 100% recyclable, are composed of minimum 25% recycled content and up to 40% recycled content, 100% controlled, are REACH compliant and rated CfI-s1 for fire resistance. Designed and manufactured in a sustainable way in a plant awarded with ISO 9001 (quality), ISO 14001 (environment) and ISO 50001 (energy) certifications, the floorings are Cradle to Cradle certified™ Bronze (Marmorette AcousticPlus, Colorette AcousticPlus) and Cradle to Cradle certified™ Silver (Marmorette Acoustic). Their Environmental Performance Declaration (EPD) certified by an external laboratory, indicate carbon neutrality during the first stages of their life cycle ("from cradle to gate"). The Camouflage (Marmorette) or Uni (Colorette, Uni Walton, Lino Art) welding rod makes the connections between the strips invisible. They are antistatic, antibacterial according to ISO 22196 / JIS Z 2801 and antiviral according to ISO 21702.



# Acoustic Linoleum

## Marmorette Acoustic

Comfort 15 dB Neocare™ 4 mm



0019 Sunset Orange  
4.0 mm



0098 Desert Beige  
4.0 mm



0045 Sand Beige  
4.0 mm



0059 Plumb Grey  
4.0 mm



0053 Ice Grey  
4.0 mm



0023 Dusty Blue  
4.0 mm

All other colours can be manufactured in Acoustic 15 dB version.  
Special request - Minimum order quantity: 1500 sqm. Below 1500 sqm, use Korkment underlayer.

## Marmorette Acoustic Plus

Comfort 19 dB Neocare™ 4 mm



0130 Antique Green  
4.0 mm



0022 Autumn Blue  
4.0 mm



0023 Dusty Blue  
4.0 mm

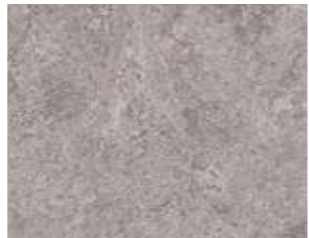

0153 Greystone Grey  
4.0 mm



0073 Spicy Orange  
4.0 mm



0070 Rocky Brown  
4.0 mm

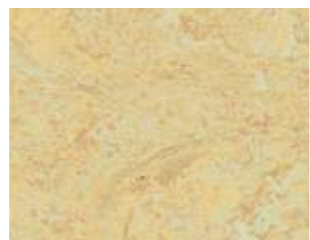

0040 Light Sahara  
4.0 mm



0045 Sand Beige  
4.0 mm



0096 Midnight Grey  
4.0 mm



0059 Plumb Grey  
4.0 mm



0053 Ice Grey  
4.0 mm



0158 Tabac Grey  
4.0 mm

All other colours can be manufactured in AcousticPlus 19 dB version. Special request - Minimum order quantity: 58 sqm.

## Colorette Acoustic Plus

Comfort 19 dB Neocare™ 4 mm



0012 Light Beige  
4.0 mm



0001 Banana Yellow  
4.0 mm



0132 Spicy Green  
4.0 mm



0052 Oxyd Grey  
4.0 mm



0059 Stone Grey  
4.0 mm



0080 Elephant Grey  
4.0 mm

## Uni Walton Acoustic Plus

Comfort 19 dB Neocare™ 4 mm



0085 Warm Concrete Grey  
4.0 mm



0058 Clay Grey  
4.0 mm



0083 Architects Grey  
4.0 mm



0095 Spring Blue  
4.0 mm



0090 Olive  
4.0 mm



0010 Pompeji Red  
4.0 mm

## Lino Art Urban Acoustic Plus

Comfort 19 dB Neocare™ 4 mm

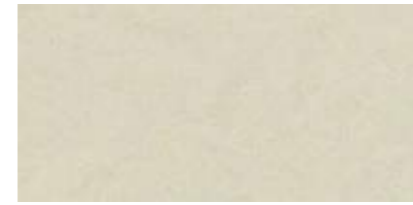

0564 Natural Stone  
4.0 mm



0556 Mud Grey  
4.0 mm



0558 Screed Grey  
4.0 mm



0554 Concrete Grey  
4.0 mm



0553 Dark Concrete Grey  
4.0 mm



0561 Pitch Black  
4.0 mm

All other colours can be manufactured in AcousticPlus 19 dB version. Special request - Minimum order quantity: 58 sqm.



# Technic Linoleum

## Linodur - High Mechanical Traffic Resistance

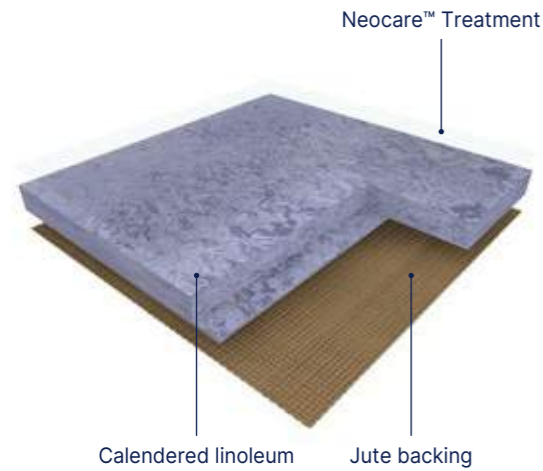

**LINODUR** is a calendered linoleum compact floorcovering in sheet, 2m wide, providing excellent resistance to everyday wear and tear in high pedestrian and mechanical traffic areas. Its weight is 4700g/sqm in 4.0mm. It features a modern design with a fine grain effect and is composed of 98% natural materials (linseed oil, wood flour, resins, minerals and jute fabric) among of which 76% are rapidly renewable. The flooring is produced with Neocare™ solvent-free surface treatment, an exclusive photo-cured acrylate based lacquer surface treatment obtained by triple laser UV cross linking. Neocare™ offers excellent scratch resistance as well as resistance to chemicals found in aggressive environments such as bleach, hydro alcoholic solutions, Betadine and Eosin as well as markers making maintenance easier and increasing the life of the flooring. This treatment avoids performing any polishing throughout the lifetime of the product. It can however be polished following usual recommendations and according to the customer's wishes. The Camouflage welding rod makes the connections between the strips invisible. It is antistatic, antibacterial according to ISO 22196 / JIS Z 2801. The flooring is 100% recyclable, is composed of up to 32% recycled content and up to 40% recycled content, 100% controlled, is REACH compliant and rated Cfl-s1 for fire resistance. This product is manufactured in a plant awarded with ISO 9001 (quality), ISO 14 001 (environment) and ISO 50001 (energy) certifications. The product also benefits from international certifications such as Floorscore® and Blue Angel (emissions).

## Marmorette LCH - Dissipative Linoleum For ESD Areas

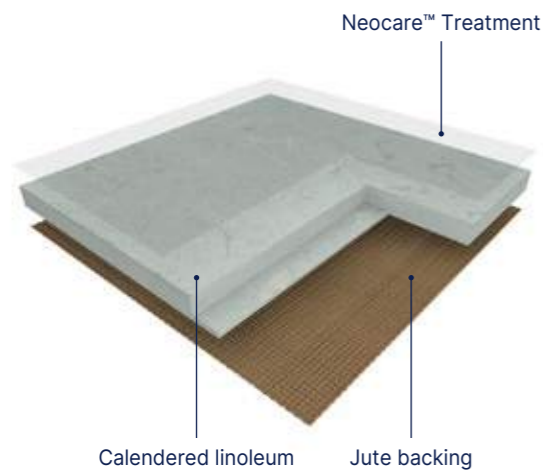

**MARMORETTE LCH** is a calendered linoleum compact dissipative floorcovering in sheet, 2m wide, providing excellent resistance to everyday wear and tear in high traffic areas. Its vertical resistance is  $10^6 < R < 10^8 \Omega$ . Its weight is 3000g/sqm in 2.5mm. It features a marbled design and presents a matt finish, is composed of 98% natural materials (linseed oil, wood flour, resins, cork, minerals and jute fabric) among of which 76% are rapidly renewable. The flooring is produced with Neocare™ solvent-free surface treatment, an exclusive photo-cured acrylate based lacquer surface treatment obtained by triple laser UV cross linking. Neocare™ offers excellent scratch resistance as well as resistance to chemicals found in aggressive environments such as bleach, hydro alcoholic solutions, Betadine and Eosin as well as markers making maintenance easier and increasing the life of the flooring. This treatment avoids performing any polishing throughout the lifetime of the product. It can however be polished following usual recommendations and according to the customer's wishes. The flooring is 100% recyclable, is composed of minimum 25% recycled content and up to 40% recycled content, 100% controlled, is REACH compliant and rated Cfl-s1 for fire resistance. It is designed and manufactured in a sustainable way in a plant awarded with ISO 9001 (quality), ISO 14001 (environment) and ISO 50001 (energy) certifications. The Camouflage welding rod makes the connections between the strips invisible. It is antistatic, antibacterial according to ISO 22196 / JIS Z 2801.

## Linodur - High Mechanical Traffic Resistance



1020 Spring Blue  
4.0 mm



1024 Speckled Blue  
4.0 mm



1056 Marble Grey  
4.0 mm



0020 Spring Blue



1081 Sporty Black  
4.0 mm

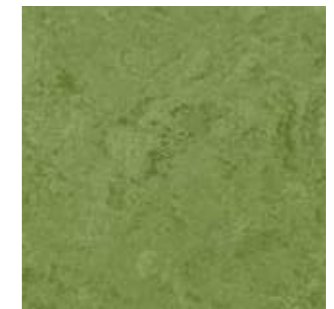

1011 Avocado Green  
4.0 mm



1072 Peach Orange  
4.0 mm

## Marmorette LCH - Dissipative Linoleum for ESD areas



0023 Dusty Blue  
2.5 mm



0055 Ash Grey  
2.5 mm



# Finishes

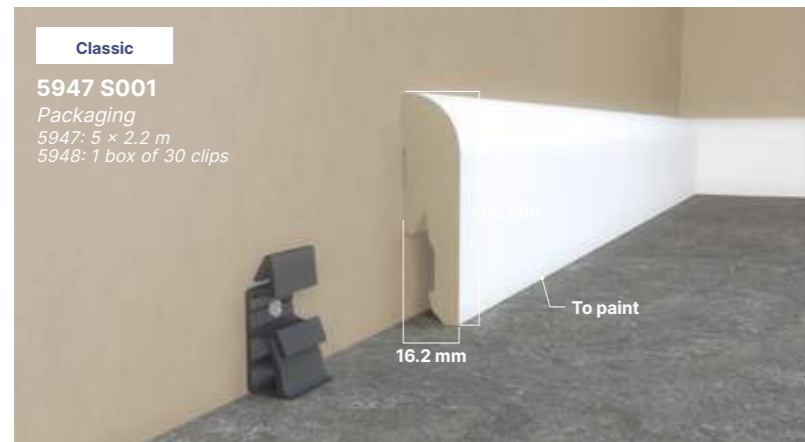

**MDF**  
 Color: White



**Cove Former**  
 Color: 6512

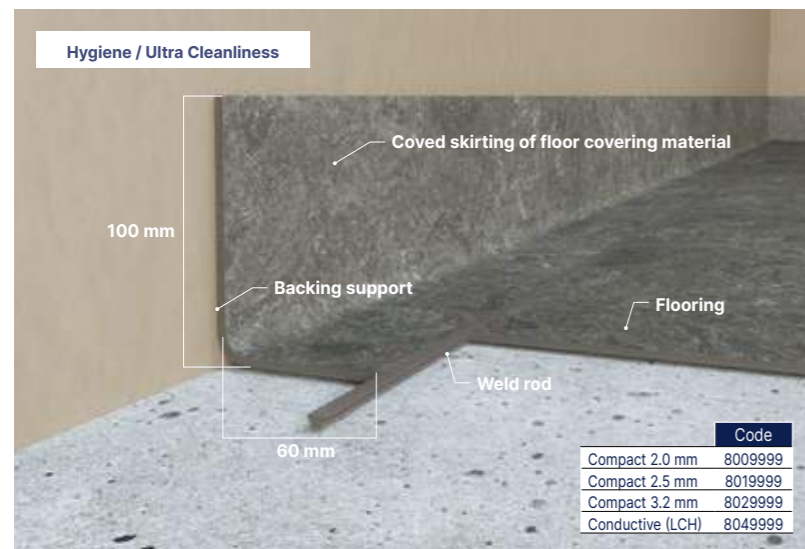

**HSLA**

# Cleaning Neocare™-Treated Linoleum Floors

Marmorette / Colorette / Uni Walton / Lino Art

**Damp sweeping equipment**  
 Flexible mop preferably fitted with disposable, antistatic and/or pre-impregnated gauze strips

**Single disk machine**

**Manual washing equipment**  
 Disposable microfibre mop or gauze

**Autoscrubber**

**Mechanical cleaning disk**  
 3M (or equivalent) colour disks

	Equipment used	Cleaning products	Cleaning methods
<b>First use</b>			
<b>Manual or mechanical cleaning</b>	or	Neutral detergent or Alkaline detergent	<ul style="list-style-type: none"> <li>Damp sweeping</li> <li>Mechanical washing at 160-200 rpm (with water recovery)</li> </ul>
<b>Daily cleaning</b>			
<b>Manual cleaning</b>		Neutral detergent / Disinfectant detergent <sup>(1)</sup>	<ul style="list-style-type: none"> <li>Damp sweeping</li> <li>Manual washing with flat mop</li> <li>Rinsing</li> </ul>
<b>OR</b>			
<b>Mechanical cleaning</b>	or	Neutral detergent	<ul style="list-style-type: none"> <li>Damp sweeping</li> <li>Mechanical washing at 160-200 rpm (with water recovery)</li> </ul>
<b>Deep cleaning</b>			
<b>Mechanical cleaning</b>	or	Alkaline detergent	<ul style="list-style-type: none"> <li>Damp sweeping</li> <li>Mechanical washing at 160-200 rpm (with water recovery)</li> </ul>

(1) In areas where disinfection is essential (e.g. operating theatres, hospital rooms, etc.), alternate between using neutral detergent and amine-free disinfectant detergent.

These cleaning instructions have to be adapted depending on traffic and location of the area.

## Welding rods

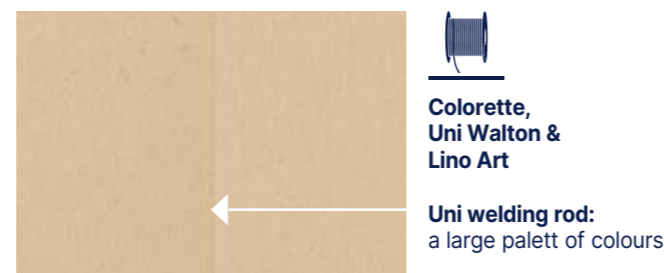

Welding rod matching table available on: gerflor.com

Gerflor DLW flooring products are to be installed in full accordance with Gerflor DLW installation instructions and recognized trade standards. An effective, regular cleaning and maintenance program is vital for retaining a high appearance level. Gerflor DLW flooring products should only be used as floorcoverings.

Note: Gerflor DLW reserve the right to amend this specification without giving prior notice. For the latest versions of the technical specifications, check our website: [www.gerflor.com](http://www.gerflor.com)

**INSTALLATION & MAINTENANCE GUIDELINES AVAILABLE ON GERFLOR.COM**





## Sports Floorings

pages 328-371

- 334. **Taraflex® New**  
Synthetic Sports Floorings
- 356. **Connor Sports®**  
Hardwood Flooring System
- 358. **Sport Court®**  
Outdoor Surfaces
- 364. **DLW**  
Linoleum Sports Floorings
- 368. **Powershock**  
Fitness Rubber Solutions
- 371. **Our solutions for yor fitness center**



# Gerflor, where champions play



## Indoor synthetic floors: the best performing products on the market

Taraflex® has been one of the pioneer in 1947 when developing synthetic floors and is today the world leading brand for indoor sports floor.

With a complete range of products, Gerflor offers the perfect solution adapted to all users and usages, from low impact activities through to elite and performance sports. Gerflor sets itself the highest standards when it comes to the environmental quality of its products.

Made in France 

## Taraflex® sport floors are recognised all over the world

Every day more than **8 millions children** play on a Taraflex® sports floor.

Per year, **3 500**

high level competitions are played on a Taraflex® sports floor.



Hardwood flooring systems: more than 100 years of experience



Founded in 1872, Connor Sports® is the market leader in portable and permanent hardwood sports flooring systems. Connor Sports® professional engineers lead the industry in new product design and development, setting the standard for innovative solutions in sports surfacing. In 1914, Connor Sports® installed the first basketball court in the USA. In the late 90's, Boston Celtics selected Connor Sports® to repurpose their famed parquet into a portable flooring system.

*Please check availability in your zone with your local representative.*



Outdoor surfaces: world's leading outdoor sport surface



In 1974, Sport Court® created the outdoor game court. Since then, over 150,000 courts have been installed worldwide. Sport Court®'s superior outdoor play surface is designed to:

- keep athletes safe
- allow for year-round sports activity
- eliminate costly annual maintenance



Indoor sport areas: historic leader in linoleum sport flooring



DLW Linoleum has been manufacturing high class sport linoleum for over 30 years and is proud to deliver uncompromising product quality. Adapted to both specific and multi-function use, linoleum high performance floors are a great option to address various applications, from kindergartens to multipurpose halls and fitness centres. Thanks to its acknowledged sustainable features, millions of square metres of sport linoleum have been installed over the years and still convince new generations of users.



# Partner of major events

## Official and exclusive floor supplier

Taraflex® has become the trusted historical partner to a host of well-known major international sporting federations, delivering exclusive partnerships which demonstrates Gerflor's position as a worldwide leader in sports flooring.



# Gerflor, supplier of major international sports events



Sport is a catalyst for values such as solidarity and unity. At Gerflor, we embody these principles by designing Taraflex® sports flooring to promote an inclusive experience. We are proud to promote inclusion by designing products for Paralympic sports such as sitting volleyball and boccia. It enables everyone to actively participate and feel valued in the world of sport.

*"Gerflor Taraflex® is an amazing floor. Our athletes look forward to playing on this surface. They tell me they can move well because it slides well. They also appreciate the padding on the floor. It takes a lot of pressure off their shoulders, arms, and hands when they move. It is a fantastic floor for sitting volleyball!"*

**Bill Hamiter**, Women's Head Coach/Program Director, Sitting Volleyball USA National Team.





# Taraflex® Sport Floors

## Why should you choose Taraflex®?

### Sports floors are classified into 3 categories:

- Point-elastic floors such as Taraflex® sports floors
- Area-elastic floors such as sprung wooden floors
- Combined floors, providing a combination of point-elastic and area-elastic floor features

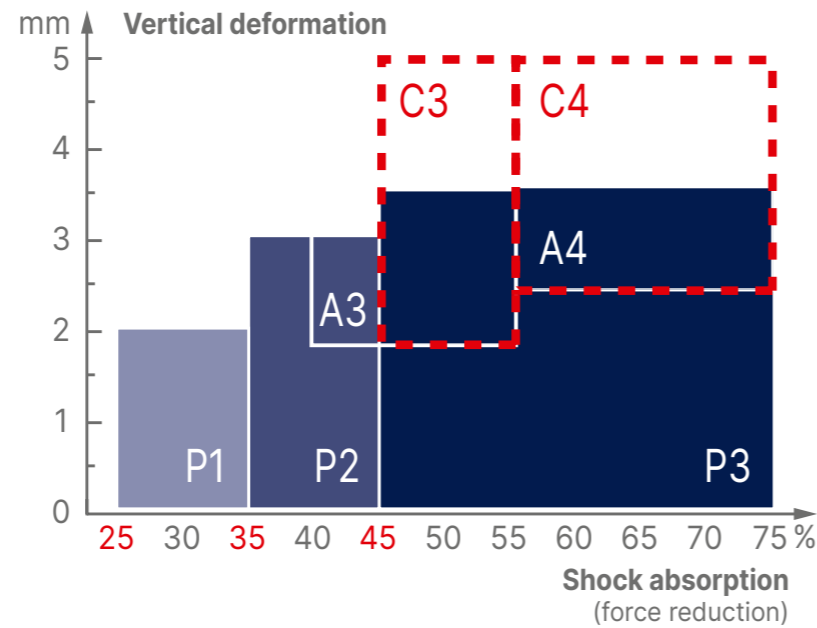

The objective of the European sport standards EN 14904 is to draw attention to the necessity of installing safe, comfortable floors. The purpose of a sports floor is to minimise the force of impact on the body and reduce the risk of long-term injury. This property is called safety and is measured by shock absorption.

EN 14904 determines shock absorption classes for all floors. A floor needs to provide minimum 25% shock absorption to be considered a sports floor.

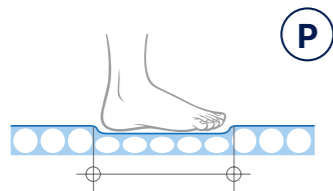

**Adapted to the greatest number of players** (children, teenagers, adults) and sports activities

#### Point-elastic floors

Point-elastic floors compress around the impact point to absorb the force of the impact. Point-elastic material deformation is a comfort indicator and makes this kind of floor particularly adapted to children. These properties make it more comfortable to walk and run, for every players.

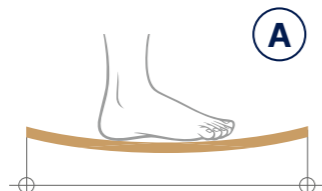

**Adapted to rolling sports and high-level basketball practice**

#### Area-elastic floors

Engineered to disperse impact energy across a wider surface area, these area-elastic floors offer athletes superior energy restitution, ensuring peak performance with every move. Plus, their unmatched ball bounce makes them the ultimate choice for top-tier sports facilities.

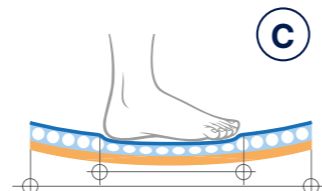

**Adapted to intense to high-level practice**

#### Combined floors

Combined floors are the association of a point-elastic floor and an area-elastic floor. They combine shock absorption and elasticity properties of these two categories. For example, Subflex Taraflex® Evolution is in this category, by association of Taraflex® Evolution, point elastic floor and Subflex cushioning wood subconstruction with foam.

### For protection

The floor that brings immediate protection on impact to all users when falling, diving or sliding on the floor.

Gerflor offers Taraflex® Comfort a P3 floor with the highest level of comfort on the market.

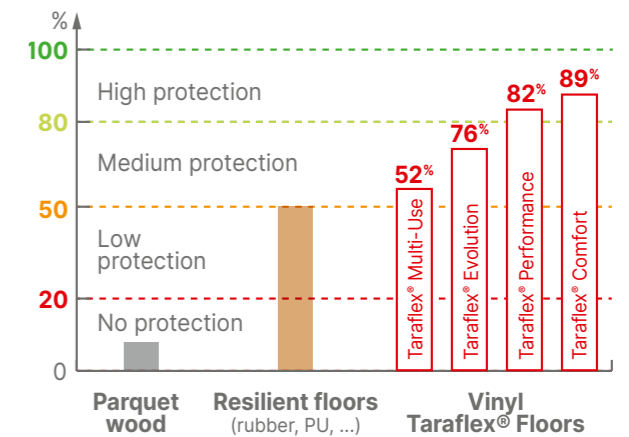

### For safety

Shock absorption **minimises the force** of impact on the body and reduces long term injury risk.

With a complete range of shock absorption P1/P2/ P3, Gerflor provides the right solution and the best safety for every user.

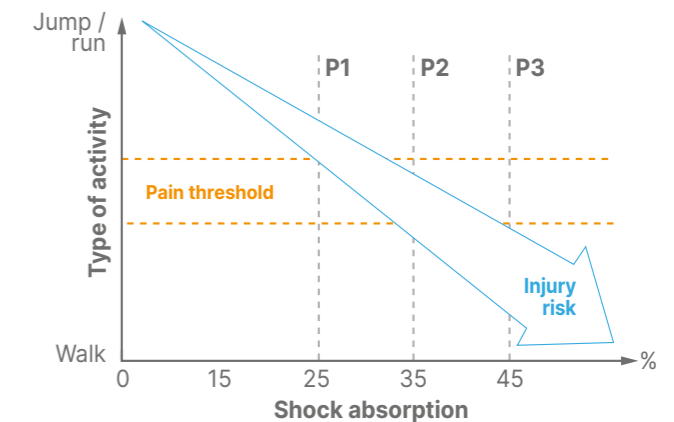

### For durability

Taraflex® technologies ensure long-lasting **High Performance**

Gerflor guarantees the category P1/P2/P3 after 15 years use\*.



"I have been Product Development Manager at Gerflor for 12 years. My constant objective has always been to meet the needs of the market and ensure the satisfaction of our sports customers. To achieve this, I work closely with the technical teams to design and continuously improve our products. Recently, we developed the new Taraflex® products, taking care to incorporate bio-sourced content while maintaining our quality standards."

R&D - Gerflor

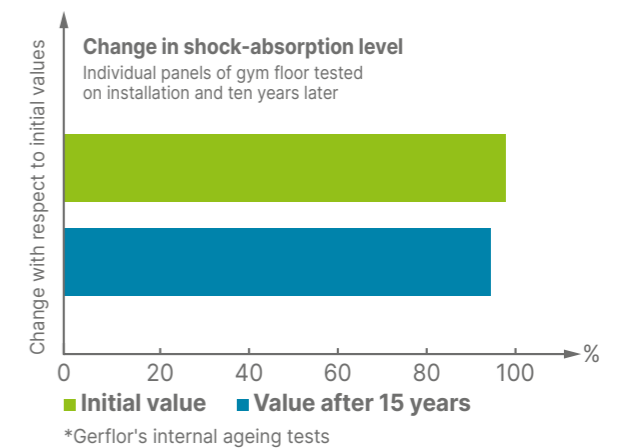

\*Gerflor's internal ageing tests



# Taraflex® Sport Floors

Why should you choose Taraflex®?

Sport floors are classified into 2 different levels of versatility:

- Light versatility
- Heavy versatility

Heavy or light versatility is determined by the weight of the sports and extra-sports equipment used and the duration of the load.

## Light Versatility

Rule of the light versatility according to the standard EN 14904

- Weight: <10 kg/cm<sup>2</sup>
- Duration of non-sport activities solicitation: 5h



Chair occupied  
up to 100 kg

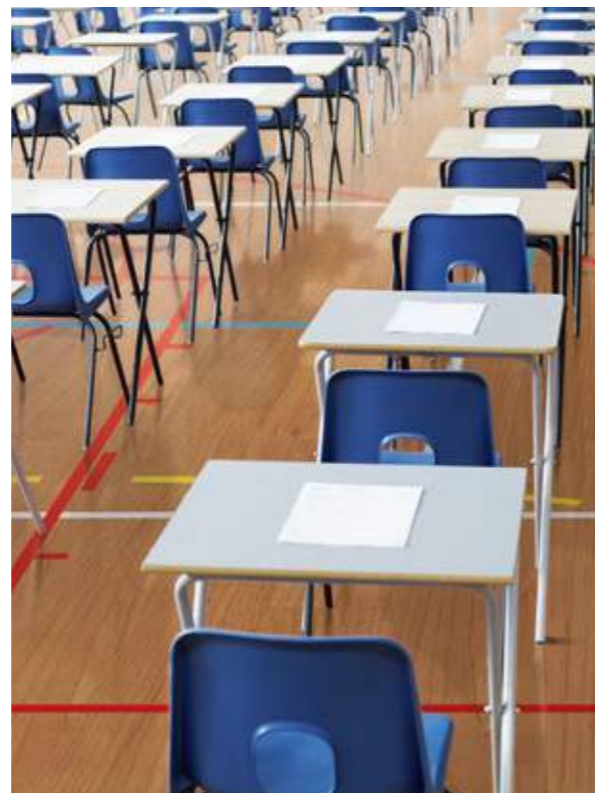

## Heavy Versatility

Rule of the heavy versatility

- Weight: 10 to 50 kg/cm<sup>2</sup>
- Duration of non-sport activities solicitation: 12h to 24h



Bleacher  
up to  
1500 kg



Platform  
380 kg



Concert  
scene  
500 kg



Machine on 4 wheels  
up to  
2000 kg



## IPI: Impact Protection Index

**Protection** is the property of the floor that reduces immediate injuries when falling, diving, sliding on the floor for all users (children, adults, athletes...)

**Protection** is not considered by EN 14904 but is an important criteria, as in many instances sports floors are used for educational purposes.

**Gerflor measures protection** with the Impact Protection Index and defines 3 categories of protection:

### IPI = Impact Protection Index

≤ 50%	low protection
50% < IPI ≤ 80%	medium protection
> 80%	high protection

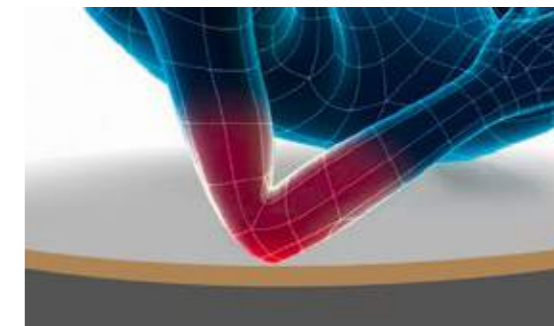

Small surface impact area, **low IPI floors**, high risks of immediate injuries.

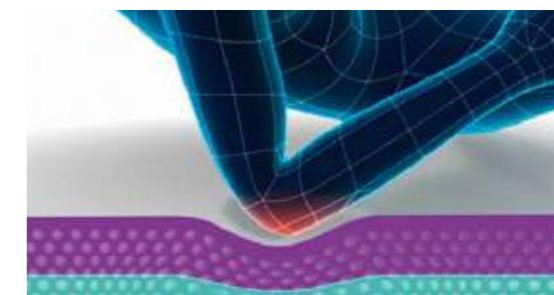

High impact surface area, **high IPI floors**.



## Choosing a sports floor requires a good understanding of the usage of the sports hall:

- Type of users: from children to high level athletes
- Type and variety of sports
- Type of sport equipment: tennis or volleyball posts, gym equipment, ...
- Use for activities other than sport: exams, concerts, requiring other specific equipment



# Taraflex® Sport Floors

Champions in Sustainability

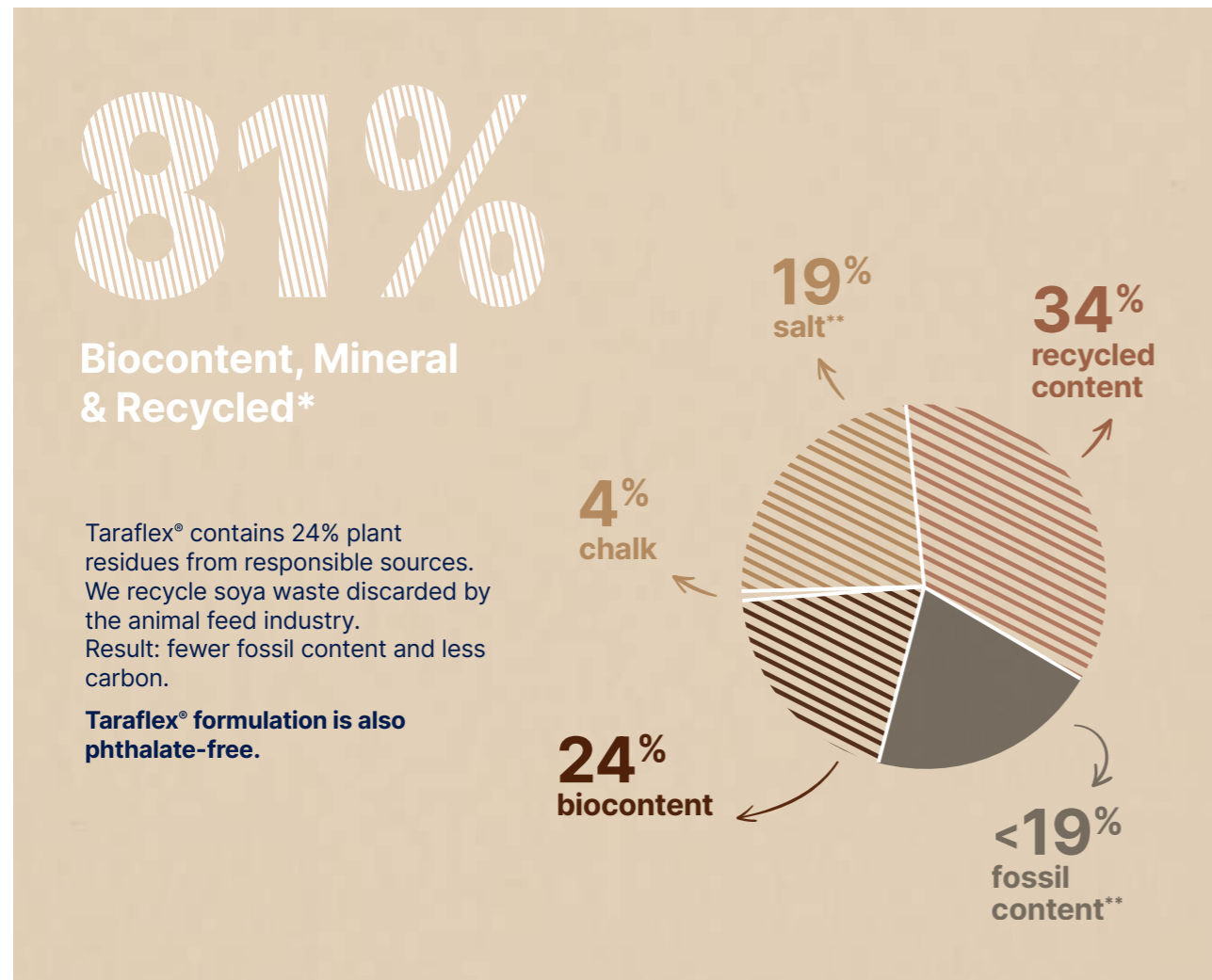

## Best in class carbon footprint



Thanks to 360° eco conception, Taraflex EPD is the lowest of the sports flooring market.

**A good choice for decarbonising your projects.**

## 100 % recyclable



All Gerflor floorings are 100% recyclable and eligible to **Gerflor Second Life collection and recycling program**. Free collection of installation waste is available in 10 countries.

## The secret of Taraflex® Sport Flooring

### 1 ProtecSol®

An intelligent surface with the unique and patented triple action ProtecSol®:

- Best solution to maximise both slide and grip
- A friction-burn free surface, on which the temperature during a fall is reduced by 25%
- Cost effective and easy to maintain

### 2 D-Max™

D-Max™ surface is a UNIQUE complex made of calendered PVC sheets reinforced with a fibreglass grid.

- High durability
- Outstanding dimensional stability

### 3 CXP™ HD

Taraflex® CXP-HD dual-density foam provides shock absorption for ideal player protection and safety.

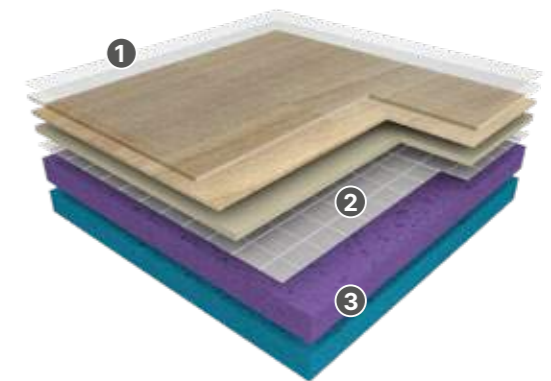

## 4 different foams

Low Density	Density +	Density ++	Density +++
Lightness	Elasticity	Energy restitution	Compactness

## 3 types of products

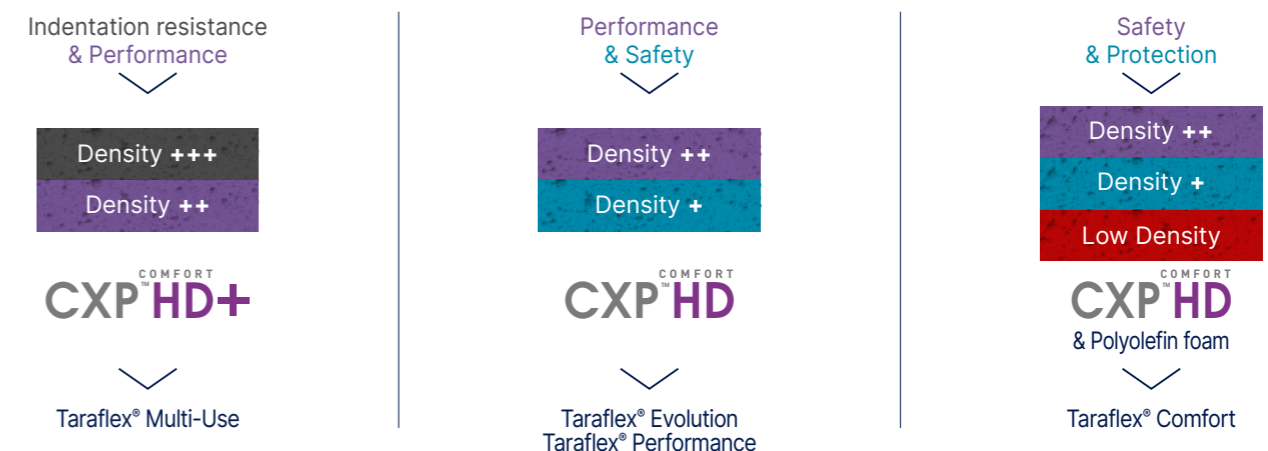

"I'm committed to listening carefully to our customers to find solutions to their problems, while promoting Taraflex®, 'the floor of champions'. Whether young, amateur, professional or senior, I believe that every player has the right to the best possible floor. This conviction has driven my daily work for the past 7 years, to continue to offer excellence and create great experiences of conviviality, pleasure and optimal performance over time on #Taraflex®."

Sports Product Marketing Manager

\*Taraflex® Evolution solid colours

\*\* Vinyl is made from two primary ingredients: salt (abundant mineral) and ethylene (fossil)



# Taraflex® Sport Floors

How to choose the right floor?

## Multi Sport, Education, Club & Competition

### Taraflex® Evolution

The reference in sports flooring

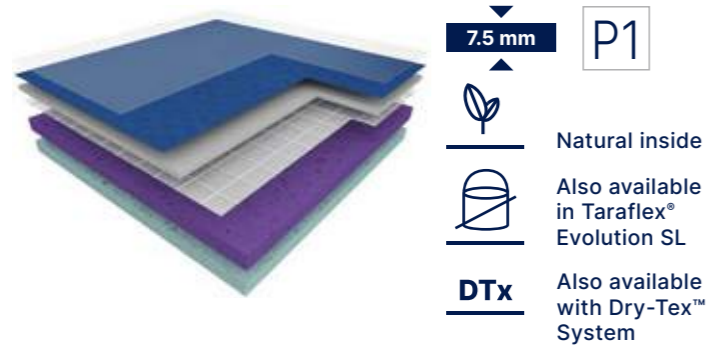

### Taraflex® Performance

Best balance of sport performance and safety

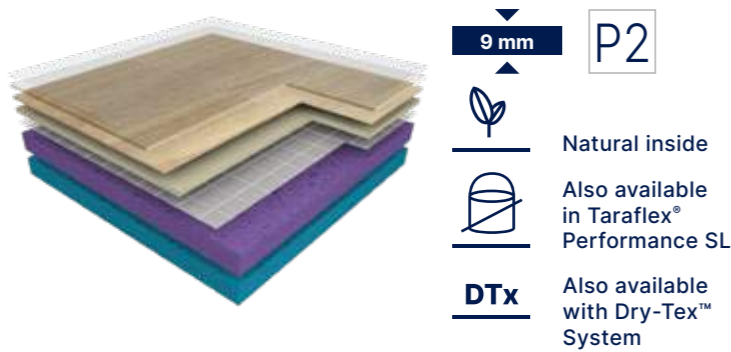

### Taraflex® Comfort

Maximum protection & safety

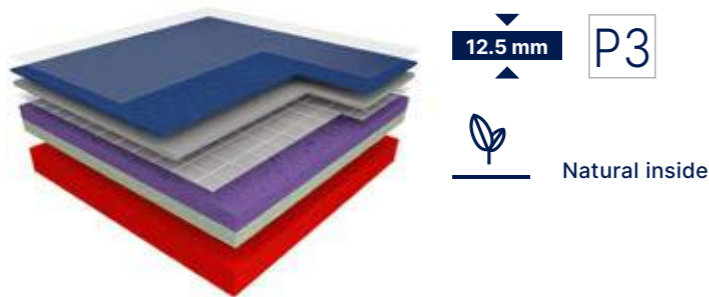

## Multi Purpose, Sport & Non-Sport Activities

### Taraflex® Surface

Compact surface, to be used alone or on sub-construction\*

\*Meets EN14904 with sub-construction

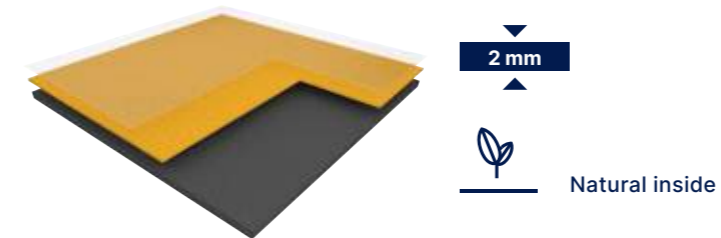

### Taraflex® Multi-Use

Performance & very high indentation resistance

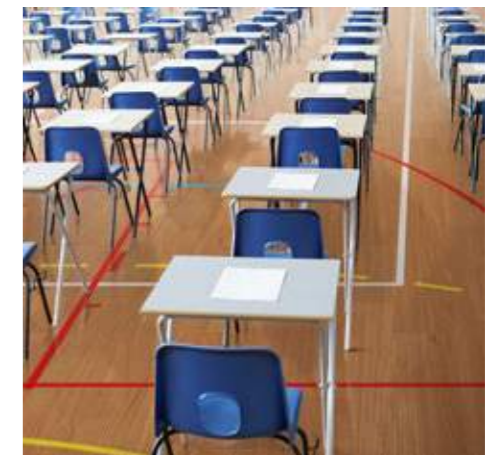
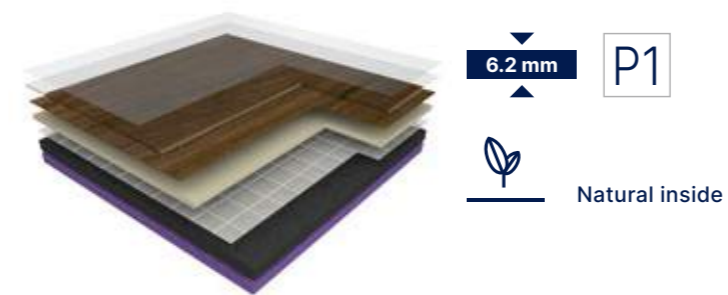

	Basketball	Volleyball	Handball	Netball	Floorball	Futsal	Table Tennis	Badminton	Multi-sports	Rolling Sports & Wheel sports	Disability sports	Heavy versatility	Light versatility
Taraflex® Evolution (P1)	■	■	■	■	■	■	□	■	■	□	×	×	■
Taraflex® Performance (P2)	□	■	■	■	■	■	×	□	■	□	□	×	□
Taraflex® Comfort (P3)	×	□	□	□	□	□	×	□	■	×	■	×	×
Taraflex® Multi-Use (P1)	□	□	□	□	□	□	■	■	■	■	×	■	■
Taraflex® Surface	■	□	□	□	□	□	□	□	■	■	×	■	■

Installed over undercarriage system

■ = Recommended / □ = Possible / × = Not recommended



# Taraflex® Sport Floors

## Smooth Harmony

Taraflex® Surface, Taraflex® Evolution, Taraflex® Performance, Taraflex® Comfort



Ecru



4345 - Ecrú / Y = 52.7

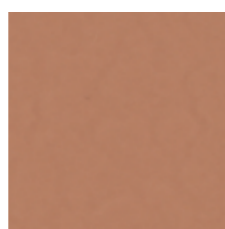

6348 - Clay / Y = 23.1



6553 - Fern / Y = 20.9



0654 - Sage / Y = 43.6



0047 - Mallow / Y = 41.6



« Sport and well-being has become an essential part of our daily lives, the balance between physical and mental fitness is like a rule of life for some people.

This new palette of softer, more contemporary colours create the right ambience for users looking for places that combine sport and relaxation but also to the expectations of architects for new sports complexes, which are often increasingly integrated into the environment.

The two new shades of green (sage and fern) are much closer to the shades found in nature and can be blend perfectly with our wood designs.

Terracotta (clay) is a colour that has been used for a long time in many sports surfaces such as tennis and athletics and this earthy colour provides a reassuring touch.

We've reworked beige (new ecru) to make them more neutral and blend in with all the other colours. Mauve (mallow) is the palette's funniest, trendiest touch. »

Designer - Gerflor

## Timeless Nature

Taraflex® Surface, Taraflex® Evolution, Taraflex® Performance, Taraflex® Comfort



6350 - Light Cherry / Y = 43.3



Scan scale: 25%

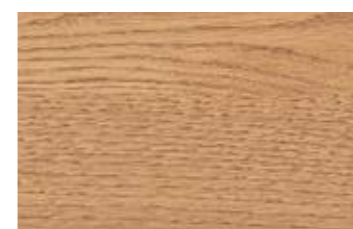

5742 - Wood Oak / Y = 27.8

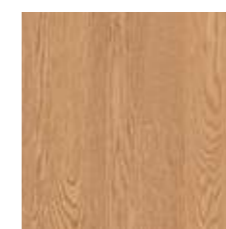

Scan scale: 25%



5763 - Maple Sun / Y = 40.2



Scan scale: 25%



6379 - Maple Desert / Y = 23.2

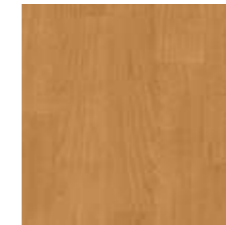

Scan scale: 25%



Light Cherry & Wood Oak



# Taraflex® Sport Floors

## Colourful Games

Taraflex® Surface, Taraflex® Evolution, Taraflex® Performance, Taraflex® Comfort



2404 - London Light Blue / Y = 33.8

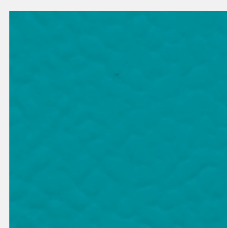

6431 - Teal / Y = 19.2

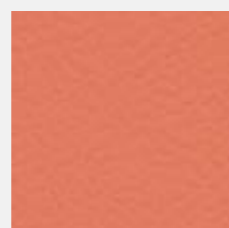

6146 - Coral / Y = 27.8



6038 - Terracotta / Y = 19.9

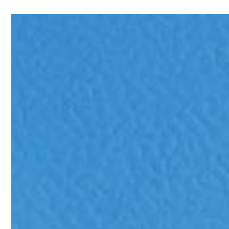

6445 - Lagoon / Y = 24.9



6570 - Mint Green / Y = 16.6



6211 - Gold / Y = 41.5



6180 - Red / Y = 9.8



6430 - Blue / Y = 8.0

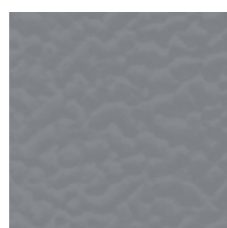

6873 - Anthracite / Y = 20.5



6758 - Silver Gray / Y = 32.6

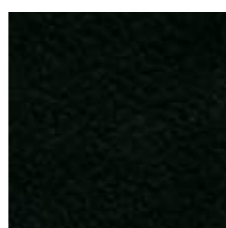

6830 - Black / Y = 3.1



© Volleyball World - Courtesy

Teal / Coral

## Masking designs for multi-use

### Taraflex® Multi-Use



6844 - Black Strips / Y = 14.5



6391 - Maple Stone / Y = 30.6



6373 - Maple Ocean / Y = 21.1



6392 - Maple Earth / Y = 10.2



6379 - Maple Desert / Y = 23.2



2790 - Polished Concrete Dark Grey / Y = 15.3



2791 - Polished Concrete Light Grey / Y = 27.4



6350 - Light Cherry Design / Y = 43.3



5742 - Wood Oak / Y = 27.8



7762 - Pure Concrete Blue / Y = 12.5



7764 - Pure Concrete Lagoon / Y = 28.7



6445 - Lagoon / Y = 24.9



6873 - Anthracite / Y = 20.5



6180 - Red / Y = 9.8



# Taraflex® Sport Floors

## Specific applications racket sports

- Racket sport floors should offer an excellent compromise between slide and grip for lateral moves, accelerations and changes of direction.
- Gerflor offers a complete range of solutions for racket sports with different types of installation methods (portable and permanent floors) to meet player's expectations and facilities needs.

### Taraflex® Table Tennis

Engineered and developed in partnership with the International Table Tennis federation (ITTF)

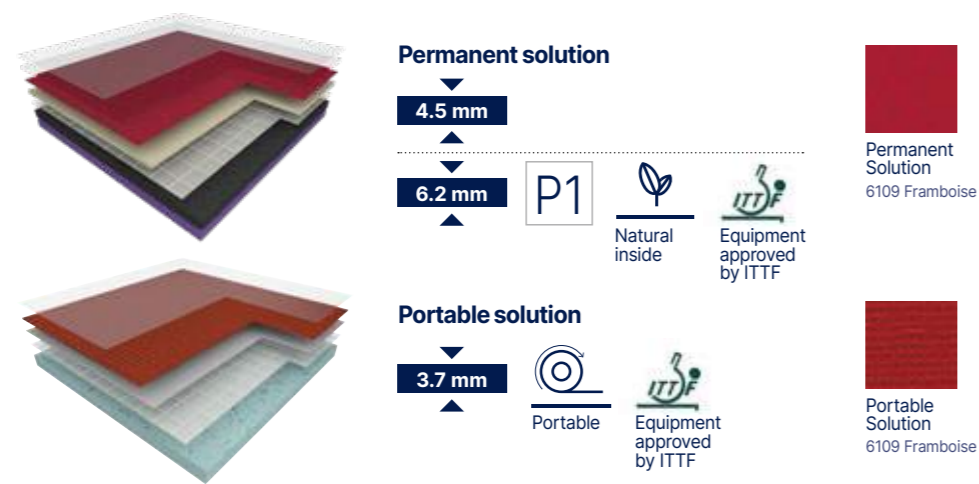

### Taraflex® Badminton

The ultimate floor for badminton movements

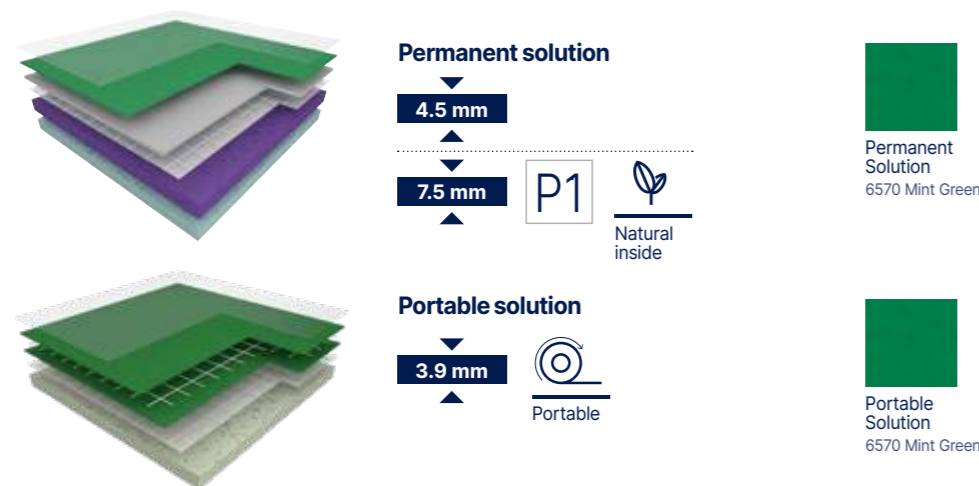

## A sub-construction for each usage

### Subflex **New**

SUBFLEX is a sports sub-construction that can be combined with a floor covering of your choice. It consists of an 18.8mm wooden panel, shock-absorbing and energy-releasing foam, and a protective layer against rising damp. These complete and combined assemblies ensure excellent sporting performance for athletes, as this sub-construction offers unrivalled stability and solidity.

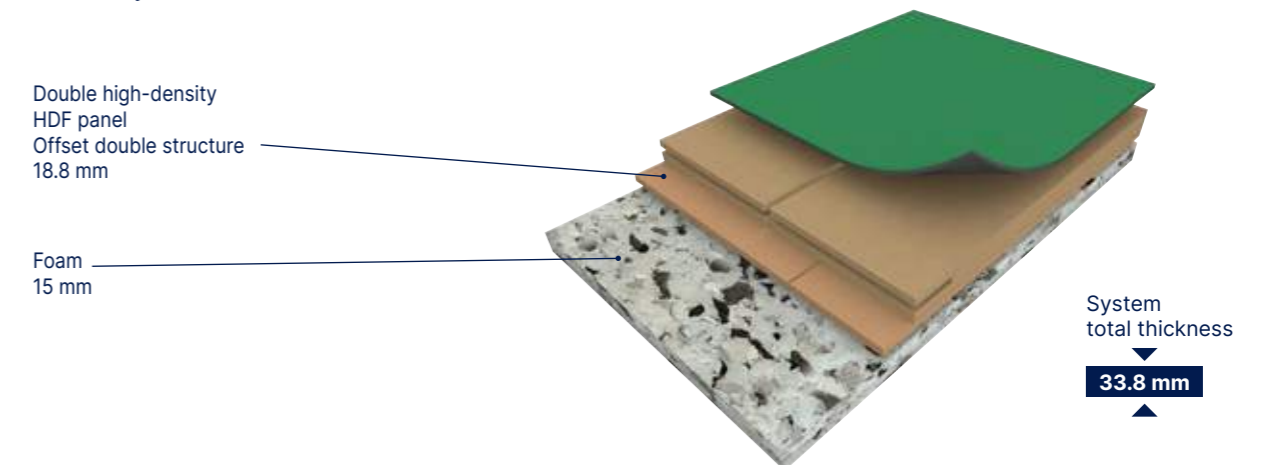

### Subflex benefits



**Resistance against humidity** rises, up to 7%



Wide ranges of designs for an **ultra-realistic wood aspect**



No need to sand or treat joints before surface flooring installation: **easy installation**

Modular installation: **Easy to fix**

GERFLOR SOLUTION



Offset double-layer structure that enables a full assembly coverage: **solidity, stability and superior resistance to static and rolling loads**

OTHER MARKET SOLUTIONS



High-density surface with 900 kg/m<sup>3</sup> HDF: **resistance to impact, static and rolling loads**



"With SUBFLEX, we've developed a simple, high-performance sub-construction that's easy to install and allows a wide range of sports floors to be combined for an optimised playing experience."

Sports Product Manager

Available with Taraflex® Evolution, Taraflex® Surface, Taraflex® Multi-Use, Linodur Sport, Marmorette 3.2.



# Taraflex® Sport Floors

## Taraflex® technologies

Gerflor has developed durable technologies to cover all types of installation, responding to the constraints of substrates, such as humidity, for renovation or temporary installation. These technical solutions can be combined with the products in the range to ensure the best performance, while preserving the sporting characteristics of Taraflex® floors.

### Adhesive free sustainable installation

#### Taraflex® SL

SL® is an installation technology that works in conjunction with our Taraflex® floors.

This installation does not require any adhesive meaning an easier, faster and more sustainable installation without compromising sport performances and quality.

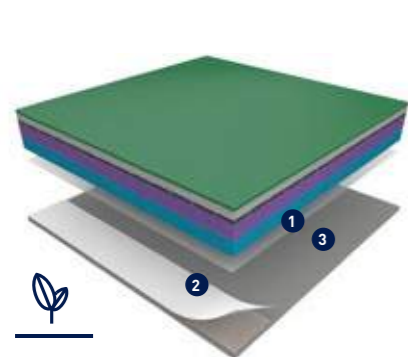

Natural inside

- 1 **Taraflex® sports flooring with reinforced textile backing**  
Improved dimensional stability allowing for the only true adhesive-free sports floor installation including onto damp sub-floors with up to 7%.
- 2 **Long-lasting Taraflex® SL holding strips**  
Strips installed under welded seams and floor perimeter to provide optimal stability and durability.
- 3 **Concrete slab**



Choose the SL solution, a smart choice representing 3 advantages in 1

#### SUSTAINABLE ADHESIVE FREE INSTALLATION

- Eliminating adhesives improves laying comfort and indoor air quality for installers and users
  - Reduce the installation time

#### EASY RECYCLING

- Eco-design: SL textile fibers are composed of recycled plastic bottles



- Can easily be reused\* or recycled



#### UNBEATABLE QUALITY & PERFORMANCE

- Same level of quality and performance as traditionally adhered Taraflex®
- High resistance to all sports demands
- Compliant with sub floors with up to 7% of humidity

Available with Taraflex® Evolution and Taraflex® Performance.  
\* Can be reused in a 10% smaller area.

### Solution for damp subfloors

#### Dry-Tex™ System

DryTex® is an installation technology that works in conjunction with our Taraflex® floors. The action between our Gerpur adhesive and a textile backing applied under the CXP-HD foam during the manufacturing process ensures unequalled stability on very damp surfaces.

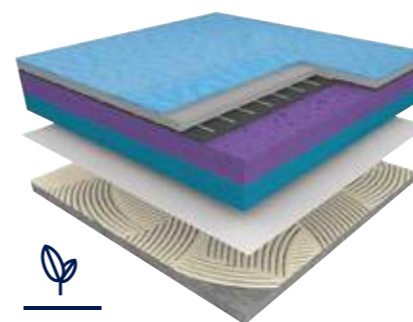

Natural inside

Available with:  
Taraflex® Evolution  
Taraflex® Performance

- **Cost-effective** - no need for additional moisture barriers (DPM's) saving both labour and material costs
- **Time-effective** - no need to wait for the slab to dry out
- **Greater durability and performance** - unbeatable bonding strength to the subfloor

#### Installation criteria:

Moisture	No limit*
Flatness	< 6mm / 3m
Surface	Hydraulic concrete**

\*No surface water on the slab  
\*\*For more information contact us

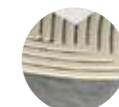

- **DTx™** textile material with CXP HD foam backing
- **GERPUR** proprietary mono component adhesive that reacts to humidity: the higher the moisture, the quicker the bonding!

### Solution for cost-effective renovation works

#### Taraflex® IsolSport

IsolSport is a non-adhesive technical underlay that uses a foam formulation optimised and researched by the R&D department to provide technical and sporting properties suited to all types of application. This solution can be applied to damp substrates and is ideal for renovation.

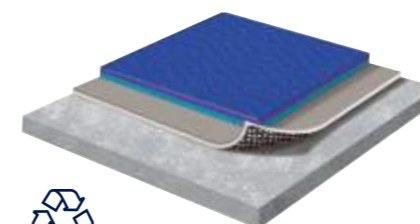

100% recyclable

Available with Taraflex® Evolution,  
Taraflex® Performance, Taraflex® Multi-use (and Recreation 60)

#### For damp surfaces

- Loose lay installation: save money and reduce installation times by leaving the existing floor in place
- Specific texture on the backing to allow humidity to circulate: Minimizes risks from rising dampness
- Provides a complete solution for renovation and build work

#### Installation criteria:

Moisture	RH < 92% (BS 8203) or < 7% humidity (CCM)
Flatness	< 6mm / 3m
Surface	Hydraulic concrete / Porous subfloor



# Taraflex® Sport Floors

## Technical Data

Description	Standard	Requirement	Units	Taraflex® Surface	Taraflex® Multi-Use	Taraflex® Evolution	Taraflex® Performance	Taraflex® Comfort	Taraflex® Badminton			Taraflex® Table Tennis			Taraflex® Bateco	Taraflex® Isolsport
									Portable	4.5	7.5	Portable	4.5	6.2		
Dry-Tex™ System	-	-	-	-	-			-	-	-	-	-	-	-	-	-
Taraflex® SL (Sustainable and Looseelay)	-	-	-	-	-			-	-	-	-	-	-	-	-	-
<b>Product Description</b>																
Surface treatment	-	-	-	Triple-Action ProtecSol®	Triple-Action ProtecSol®	Triple-Action ProtecSol®	Triple-Action ProtecSol®	Triple-Action ProtecSol®	Triple-Action ProtecSol®	PUR Protect®	Triple-Action ProtecSol®	Triple-Action ProtecSol®	PUR Protect®	Triple-Action ProtecSol®	-	-
Surface complex	-	-	-	D-Max™	D-Max™	D-Max™	D-Max™	D-Max™	100% Pur PVC	100% Pur PVC	D-Max™	100% Pur PVC	100% Pur PVC	D-Max™	-	-
Foam	-	-	-	-	CXP-HD +™	CXP-HD™	CXP-HD™	CXP-HD™	CXP	CXP	CXP-HD™	CXP	CXP	CXP-HD+™	-	-
Thickness	EN ISO 24346	-	mm	2	6.2	7.5	9	12.5	3.9	4.5	7.5	3.7	4.5	6.2	1.5	1.65
Weight	EN ISO 23997	-	kg/m²	2.7	4.2	4.7	5.2	5.1	1.95	2.6	4.7	1.9	2.6	4.2	2.05	1.35
Length*	EN ISO 24341	-	lm	26.5 Max	26.5 Max	26.5 Max	26.5 Max	26.5 Max	16 STD	20.5 STD	26.5 Max	16 STD	20.5 STD	20.5 STD	20 / 30	45 Max
Width	EN ISO 24341	-	lm	1.5	1.5	1.5	1.5	1.5	3 x 2.7	1.5	1.5	1.5	1.5	1.5	1.5	2
<b>Sport Properties</b>																
Shock absorption	EN 14808	≥ 25	%	-	P1	P1	P2	P3	-	-	P1	-	-	P1	-	-
Vertical deformation	EN 14809	≤ 3.5	mm	≤ 2	≤ 2	≤ 2	≤ 3	≤ 3.5	≤ 2	≤ 2	≤ 2	≤ 2	≤ 2	≤ 2	-	-
Sliding coefficient	EN 13036-4	80 to 110	-	80 to 110	80 to 110	80 to 110	80 to 110	80 to 110	80 to 110	80 to 110	80 to 110	80 to 110	80 to 110	80 to 110	-	-
Ball bounce	EN 12235	≥ 90	%	≥ 90	≥ 90	≥ 90	≥ 90	≥ 90	-	≥ 90	≥ 90	-	≥ 90	≥ 90	-	-
<b>Technical Characteristics</b>																
Abrasion resistance	EN ISO 5470-1	≤ 1000	mg	≤ 350	≤ 350	≤ 350	≤ 350	≤ 350	≤ 350	≤ 350	≤ 350	≤ 350	≤ 350	≤ 350	≤ 300	-
Impact resistance	EN 1517	≥ 8	N/m	≥ 8	≥ 8	≥ 8	≥ 8	≥ 8	-	-	≥ 8	-	-	≥ 8	-	-
Indentation resistance	EN 1516	≤ 0.5	mm	≤ 0.5	≤ 0.5	≤ 0.5	≤ 0.5	≤ 0.5	≤ 0.5	≤ 0.5	≤ 0.5	≤ 0.5	≤ 0.5	≤ 0.5	≤ 0.5	≤ 0.5
<b>Classification</b>																
Fire	EN 13501-1	-	-	B <sub>fl</sub> -s1	C <sub>fl</sub> -s1	C <sub>fl</sub> -s1	C <sub>fl</sub> -s1	C <sub>fl</sub> -s1	B <sub>fl</sub> -s1	C <sub>fl</sub> -s1	C <sub>fl</sub> -s1	B <sub>fl</sub> -s1	C <sub>fl</sub> -s1	C <sub>fl</sub> -s1	B <sub>fl</sub> -s1	C <sub>fl</sub> -s1
Anti-bacterial activity (E. coli - S. aureus - MRSA) <sup>(1)</sup>	ISO 22196	-	-	> 99% inhibits growth						> 99% inhibits growth						
<b>CE Marking</b>																
	EN 14 904	-	-	Fire Sliding Coefficient Abrasion Resistance Rolling load Resistance	Fire Shock Absorption Sliding Coefficient Abrasion Resistance Rolling load Resistance	Fire Sliding Coefficient Abrasion Resistance Rolling load Resistance	Fire Sliding Coefficient Abrasion Resistance Rolling load Resistance	Fire Sliding Coefficient Abrasion Resistance Rolling load Resistance	Fire Sliding Coefficient Abrasion Resistance Rolling load Resistance	Fire Sliding Coefficient Abrasion Resistance Rolling load Resistance	Fire Sliding Coefficient Abrasion Resistance Rolling load Resistance	Fire Sliding Coefficient Abrasion Resistance Rolling load Resistance	Fire Sliding Coefficient Abrasion Resistance Rolling load Resistance	Fire Sliding Coefficient Abrasion Resistance Rolling load Resistance	Fire	Fire

The proposed specifications fall within the tolerance limits usually accepted in this sector whilst still complying with standards.

(1) The implementation of an effective cleaning method is the best defence against infection

\* For different roll lengths please contact us

### INSTALLATION ON DAMP SUBFLOOR

Gerflor provides installation on Isolsport (free floating underlay) or Taraflex® Dry-Tex™ System or Taraflex® SL.

Please contact your sales representative for more information.



# Taraflex® Sport Floors

Innovative personalized services to make your floor unique

## My Taraflex®



Personalize your sports floor using the digital printing process

- **Choose from collection**  
choose one of our designs from our catalogue (examples shown below)
- **Change colour**  
recolour the standard design of your choice
- **Customise**  
create your own design

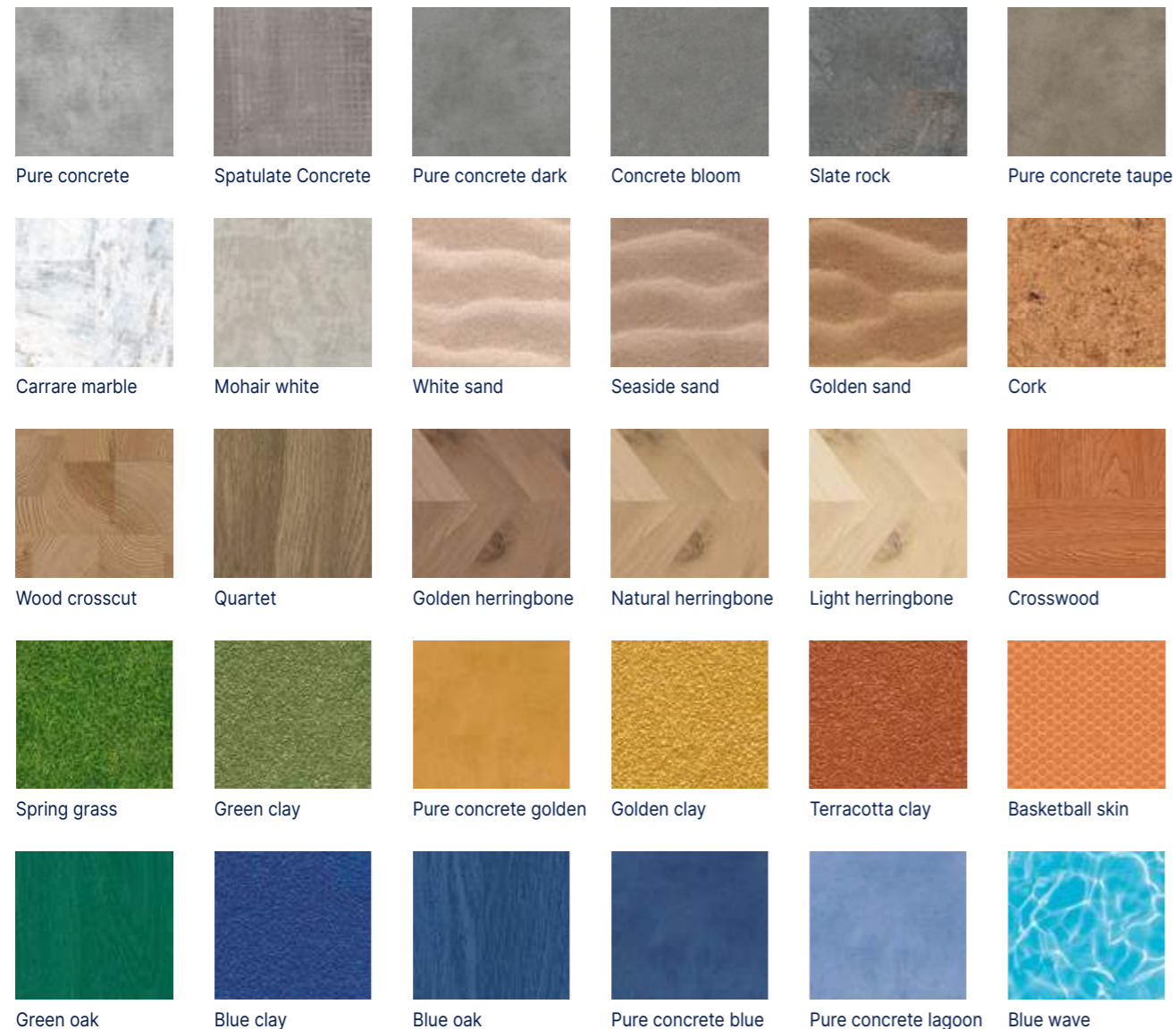

## My Logo

For a stunning result

Thanks to the waterjet cutting technology, **customize your floor** with your city or club colours. For further information, please contact your local Gerflor representative.



## 3D court designer

This intelligent tool lets you customize the sports surface of your choice and the surrounding environment in 3 dimensions to test different pitch configurations.



- 1 Choose your surface: monosport or multisports
- 2 Choose your colours
- 3 Visualise your sport hall

Available on: [courtdesigner.gerflor.com](http://courtdesigner.gerflor.com)

## Interior designer

For a realistic view of your environment

This tool lets you test different sports floors in 2 dimensions with all the colours available in the range. You can also upload your own photo.



- 1 Download your picture and include the floor
- 2 Or change the floor colours in selected pictures
- 3 Visualise your sport hall

Available on: [interiordesigner.gerflor.com](http://interiordesigner.gerflor.com)



# Taraflex® Sport Floors

A wide range of complementary solutions

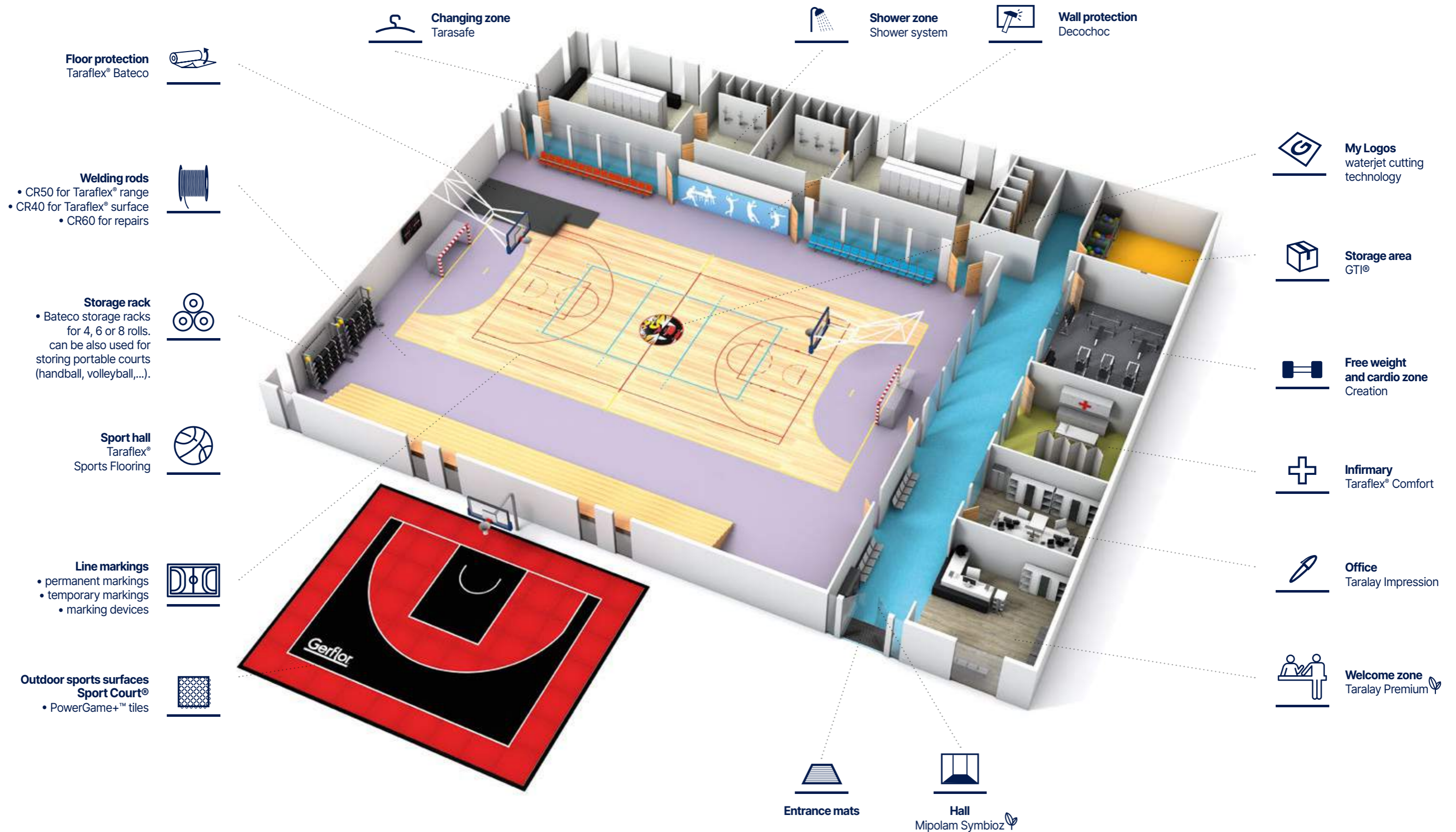



# Connor Sports® Hardwood Flooring Systems



## Where Champions Play™

### Top competitions take place on Connor Sports®

#### BASKETBALL

- ▶ 2020 Olympic Games (Tokyo)
- ▶ 2019 FIBA World Cup (China)
- ▶ 2016 Olympic Games (Rio)
- ▶ NCAA Final Four since 2006 (USA)



## Champions deserve exceptional sport surface



### So we select exceptional maple lumber for them

Connor Sports® hand selects north american maple trees grown north of the 35<sup>th</sup> parallel, where the shorter growing season produces a more dense and uniform woodgrain excellent for sports flooring.



Since its establishment in 1897, the Maple Flooring Manufacturers Association (MFMA) is the authoritative source of technical and general information about maple flooring and related sports flooring systems. Connor Sports® is a charter member of the MFMA and the 1<sup>st</sup> member of that group to be certified by the Rainforest Alliance.



Connor Sports® is proud to be the only ZeroWaste company in the sports flooring industry. Recycling, avoiding waste, developing innovative technology and a strong environmental consciousness are a major part of Connor Sports® corporate policy.



Connor Sports® works with FSC (Forest Stewardship Council®). This organization oversees high conservation value forest and protects the communities and indigenous people that rely on the forest. FSC ensures that everyone delivers the most environmentally friendly product.

## Champions of sport

### Hardwood systems for professional teams

More than half of the teams in the NBA have purchased a Connor Sports® hardwood system:



Boston Celtics



Brooklyn Nets



Philadelphia 76ers



Oklahoma City Thunder



Atlanta Hawks



Golden State Warriors



Sacramento Kings



Utah Jazz



Milwaukee Bucks

More information on [gerflor.com](http://gerflor.com)



# Sport Court® Outdoor Surfaces

Gerflor, Where Champions Play™



## Sharing more than sport!

### Bring people together for unforgettable moments and lifetime memories

With our modular PowerGame+ tiles, we offer everyone the opportunity to share such memorable sport and recreational experiences.

Our premium surfaces are not only fun, great-looking and safe to play on, but they can also be easily installed in all facilities. You can be sure you're providing the ideal playing outdoor surface for every practice and ambitions, from children to champions.

## Designed for multi-sports

Sport Court® surfaces are designed for a wide variety of sports. All game courts can be easily configured to accommodate basketball, futsal, handball, tennis and more, without compromising on playability or safety.

A number of temporary or permanent applications are possible, from multi-sport school facilities to multi-use game areas to all kinds of sporting events.



Event-based courts



School facilities



Multi-Use Game Areas



# Sport Court® Outdoor Surfaces

They trust us

## Partner of sports federations

Sport Court® surfaces are used at the highest levels of competition by leading sports federations around the world. Our courts are perfect for both temporary events and permanent installations.

**150 000**  
courts installed since 1974



## Optimal playability and safety

Powergame+ tiles provide exceptional protection against abrasion, head injuries and joint strain. Extensive third-party testing ensures that athletes of any age remain safe while playing and competing on Sport Court® surfaces.

## Accomodate many sports with unmatched playability and safety



## Powergame+ enhances game experience

- Highly versatile multisport surface
- Same dribbling response as a hardwood flooring
- Remarkably stable surface

## Powergame+ provides a unique balance between safety, comfort and durability

- High tile stability optimises ball rebound and game performance
- Improved water drainage enables faster drying and playability after rain
- Low skin abrasion protects players when falling without compromising on traction



## Long-lasting aesthetics

Design a court that makes an impression. With a selection of 10 fade-resistant tile colours, you have more ways to customise the look of your playing surfaces to fit your requirements, whether you want a fun colourful court, or to customise it with your company's or school's colours.

## Choose your colours

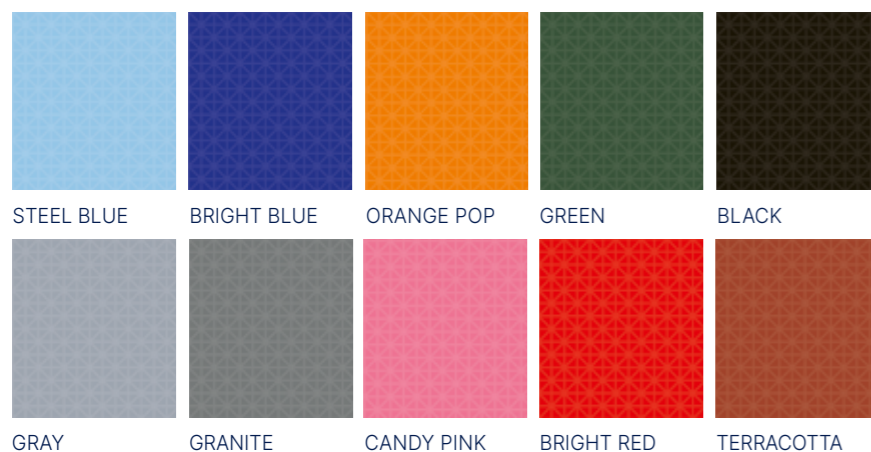

## Superior Impact Protection

A head impact from just 10 cm above a concrete surface can cause a concussion. Sport Court® tiles are significantly more forgiving, with PowerGame+ reducing the likelihood of a serious head injury from a fall of 50 cm

Critical Fall Height is a test used in conjunction with the European Standards EN 1177-2018, used for evaluating playground surfaces, such as sand, wood chips, resilient rubber and asphalt.

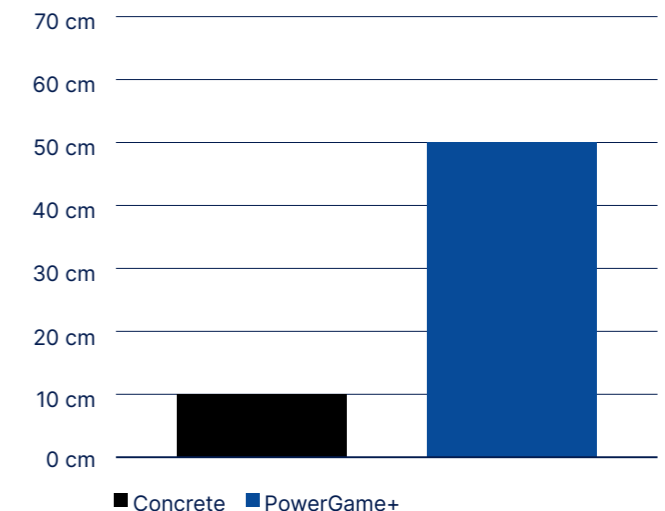



# Sport Court® Outdoor Surfaces

Save time and money

## Easy installation and maintenance

The simple and strong interlocking system enables the installation of a 1,000 sqm court in 4h



**1,000M<sup>2</sup> COURT = 4H COURT INSTALLATION + 2H GAME LINE PAINTING**

WITH A 4-PERSON TEAM

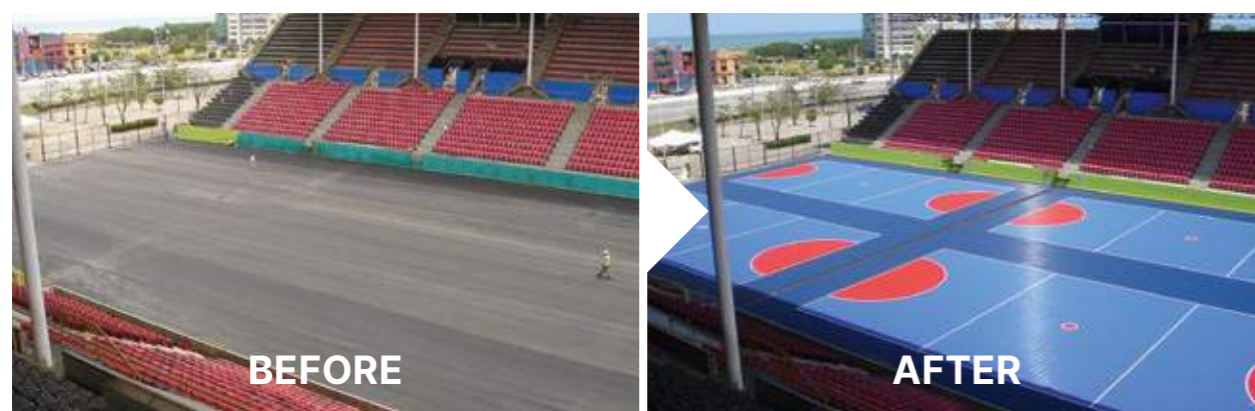
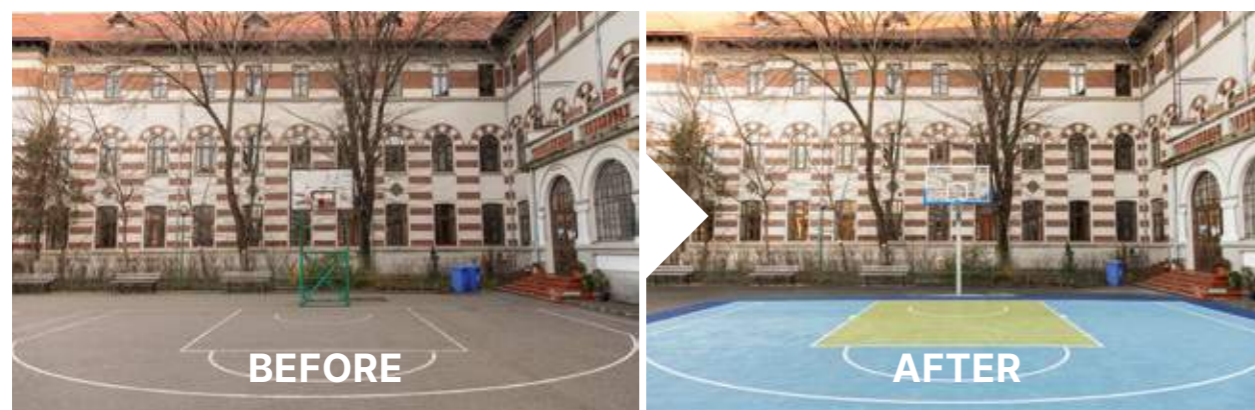

The next step in multi-sports outdoor surfacing

## POWERGAME+

Made in France  
Designed to provide the highest levels of safety and playability. PowerGame+ is the perfect choice for your facility.

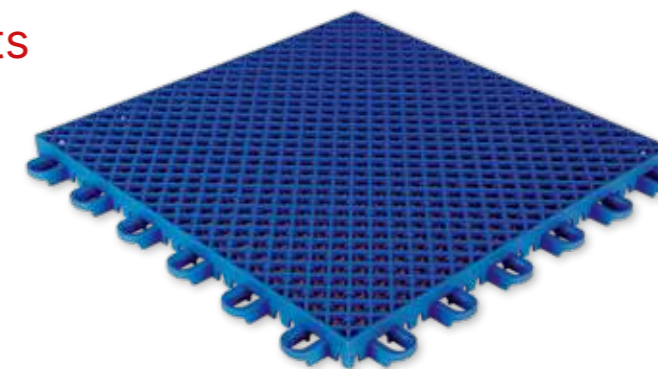

### Long-lasting aesthetics

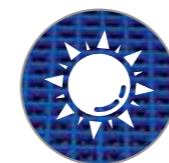

#### UV protection

Outstanding colour durability

### Durabilité et confort de jeu



#### Wide and deep connection loops

High stability and durability over installation and removal, safety of the players

### Optimal playability

#### Optimal grid design

Double-grid structure for faster drying, reduced water rebound, and optimal safety



#### Top-grid:

"Open Diamond" design  
For better drainage



#### Lower grid:

"Saddle" Shape  
To prevent water retention

A greater court with finishing profiles

Discover our complete range of finishing profiles, adapted to every court configuration.

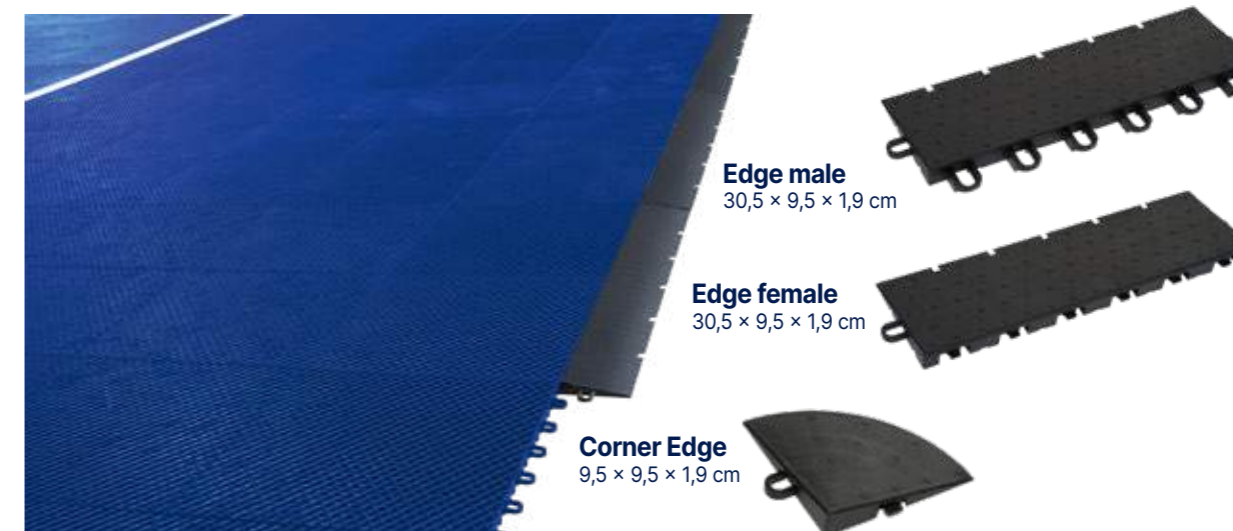

### Polypropylene Profiles

- Easy and fast installation
- Beautiful additional elements to finish the court



# Linoleum Sports Floorings

## Colorette Sport / Linodur Sport / Marmorette Sport



### Colorette Sport

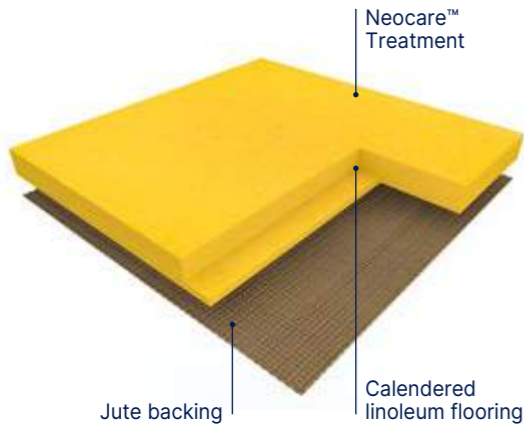

**COLORETTE SPORT** is a calendered linoleum compact floorcovering in sheet, 2 m wide, compatible with Gymflex II rubber underlay for a point elastic installation. Its weight is 4700 gr/sqm in 4.0 mm. It features a speckled design. It is composed of 98% natural materials (linseed oil, wood flour, resins, cork, minerals and jute fabric) among which 76% are rapidly renewable. The flooring is produced with Neocare™ solvent-free surface treatment, an exclusive photo-cured acrylate based lacquer surface treatment obtained by triple laser UV cross linking. Neocare™ offers excellent scratch resistance as well as resistance to chemicals found in aggressive environments such as bleach, hydro alcoholic solutions, Betadine and Eosin as well as markers making maintenance easier and increasing the life of the flooring. This treatment avoids performing any polishing throughout the lifetime of the product. It can however be polished following usual recommendations and according to the customer's wishes. The flooring is 100% recyclable, 100% controlled, is REACH compliant and rated Cfl-s1 for fire resistance. The product also benefits from international certifications such as Floorscore® and Blue Angel (emissions). Designed and manufactured in a sustainable way in a plant awarded with ISO 9001 (quality), ISO 14001 (environment) and ISO 50001 (energy) certifications, the flooring is certified "Cradle to Cradle Silver". Its Environmental Performance Declaration (EPD) certified by an external laboratory, indicates carbon neutrality during the first stages of its life cycle ("from cradle to gate").

### Linodur Sport

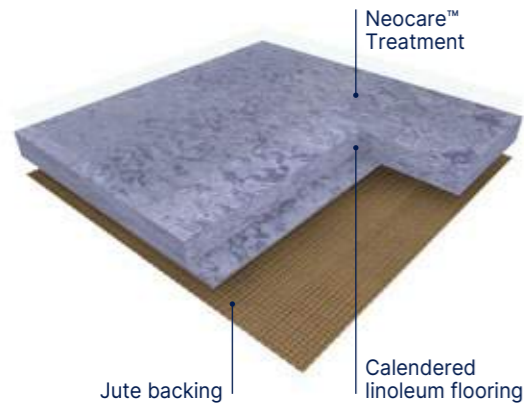

**LINODUR SPORT** is a calendered linoleum compact floorcovering in sheet, 2 m wide, compatible with Gymflex II rubber underlay for a point elastic installation. Its weight is 4700 gr/sqm in 4.0 mm. It features a modern design with a fine grain effect. It is composed of 98% natural materials (linseed oil, wood flour, resins, minerals and jute fabric) among which 76% are rapidly renewable. The flooring is produced with Neocare™ solvent-free surface treatment, an exclusive photo-cured acrylate based lacquer surface treatment obtained by triple laser UV cross linking. Neocare™ offers excellent scratch resistance as well as resistance to chemicals found in aggressive environments such as bleach, hydro alcoholic solutions, Betadine and Eosin as well as markers making maintenance easier and increasing the life of the flooring. This treatment avoids performing any polishing throughout the lifetime of the product. It can however be polished following usual recommendations and according to the customer's wishes. The flooring is 100% recyclable, is composed of up to 32% recycled content, 100% controlled, is REACH compliant and rated Cfl-s1 for fire resistance. The product also benefits from international certifications such as Floorscore® and Blue Angel (emissions). Designed and manufactured in a sustainable way in a plant awarded with ISO 9001 (quality), ISO 14001 (environment) and ISO 50001 (energy) certifications, the flooring is certified "Cradle to Cradle Silver". Its Environmental Performance Declaration (EPD) certified by an external laboratory, indicates carbon neutrality during the first stages of its life cycle ("from cradle to gate").

### Marmorette Sport

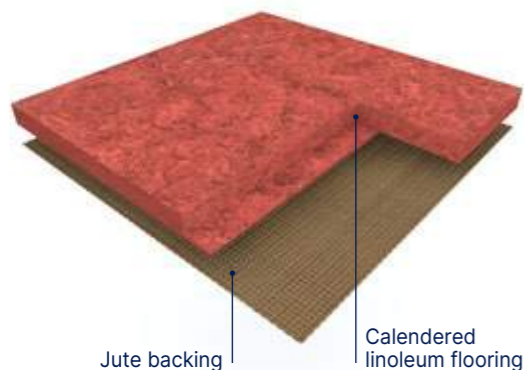

**MARMORETTE SPORT** is a calendered linoleum compact floorcovering in sheet, 2 m wide. Its weight is 3800 gr/sqm in 3.2 mm. It features a marbled design. It is composed of 98% natural materials (linseed oil, wood flour, resins, minerals and jute fabric) among which 76% are rapidly renewable. The flooring is 100% recyclable, is composed of minimum 25% recycled content and up to 40% recycled content, 100% controlled, is REACH compliant and rated Cfl-s1 for fire resistance. The product also benefits from international certifications such as Floorscore® and Blue Angel (emissions). Designed and manufactured in a sustainable way in a plant awarded with ISO 9001 (quality), ISO 14001 (environment) and ISO 50001 (energy) certifications, the flooring is certified "Cradle to Cradle Silver". Its Environmental Performance Declaration (EPD) certified by an external laboratory, indicates carbon neutrality during the first stages of its life cycle ("from cradle to gate").

## Colorette Sport / Linodur Sport / Marmorette Sport

			Colorette Sport	Linodur Sport	Marmorette Sport
<div style="display: flex; justify-content: space-around; align-items: center;"> <div style="text-align: center;">4 mm</div> <div style="text-align: center;">3,2 mm</div> </div>					
<b>Description</b>					
Total thickness	EN ISO 24346	mm	4.0	4.0	3.2
Backing	-	-	Jute fabric	Jute fabric	Jute fabric
Weight	EN ISO 23997	g/sqm	4700	4700	3800
Width of sheet	EN ISO 24341	cm	200	200	200
Length of sheet	EN ISO 24341	m	Ca. 28	app. 28	app. 28
Material content	-	-	98% natural materials (bio-based & mineral), among which 76% are rapidly renewable, 100% recyclable	98% natural materials (bio-based & mineral), among which 76% are rapidly renewable, recycled content up to 32%, 100% recyclable	98% natural materials (bio-based and mineral) : linseed oil, wood flour, resins, cork, minerals, jute fabric, among which 76% are rapidly renewable. 100% recyclable, contains up to 40% recycled
<b>Classification</b>					
Norm / Product specification	-	-	EN 14904 / DIN V 18032-2 2001/04	DIN EN 14904 DIN V 18032-2	EN 14904 / DIN 18032-2
European classification	EN ISO 10874	class	23 / 34 / 43	23 / 34 / 43	23 / 34 / 43
Fire rating	EN 13501-1	class	Cfl-s1 <sup>(1)</sup>	Cfl-s1 <sup>(1)</sup>	Cfl-s1 <sup>(1)</sup>
Dynamic friction coefficient	DIN V 18032-2 2001/04	μ	0.4 - 0.6 OK	0.4 - 0.6 OK	0.4 - 0.6 μ - Fulfilled
Sliding Coefficient	EN 13036 - 4	-	80 - 110 OK	80 - 110 OK	80-110 - Fulfilled
Impact sound insulation	EN ISO 717-2	dB	8	8	6 dB
<b>Performances</b>					
Residual indentation	EN ISO 24343-1	mm	≤ 0.20	≤ 0.20 OK	≤ 0.15
Indentation resistance	EN 1516	mm	≤ 0.5 OK	≤ 0.5 OK	-
Slip resistance	EN 16165 App B (DIN 51130)	class	R10	R10	-
Colour fastness	EN ISO 105 - B02	degree	≥ 6	≥ 6	≥ 6
Point contact resistance	VDE 0100	-	-	-	p ≥ 0.20 Fulfilled
Light reflection	DIN 5036-3	-	ρ ≥ 0.20 OK (except colours 1004,1080 und 1118)	ρ ≥ 0.20 OK (except colours 1013,1024,1059,1073,1081)	-
Static electrical propensity	EN 1815	kV	≈ 2	≤ 2	app. 2.0
Castor chair test (Type W)	ISO 4918	-	OK	OK	OK
Thermal resistance	EN 12667	(m <sup>2</sup> K)/W	0.023	0.023	0.018
Thermal conductivity	EN ISO 10456	W/(m.K)	0.17	0.17	0.17
Chemical products resistance	EN ISO 26987	class	Excellent <sup>(2)</sup>	Excellent <sup>(2)</sup>	OK
Impact resistance	EN1517	N/m	≥ 8 OK	≥ 8 OK	-
Abrasive wear resistance	EN ISO 5470-1	mg	≤ 1000 OK	≤ 1000 OK	-
Gloss level	EN ISO 2813	-	OK	OK	-
Surface Treatment	-	-	NEOCARE™	NEOCARE™	-
Anti-viral activity (Human coronavirus) after 5 h <sup>(3)</sup>	ISO 21702	-	> 98.65 % virucidal activity	> 98.65 % virucidal activity	-
Anti-bacterial activity (E. coli - S. aureus - MRSA) <sup>(3)</sup>	EN ISO 22196 (JIS Z 2801)	-	> 99.99% inhibits growth after 24h	> 99.99% inhibits growth after 24h	-
Indoor air quality (TVOC after 28 days)	EN 16516	μg/m <sup>3</sup>	< 30	< 50	-
<b>Circular Economy</b>					
Certification	Cradle to Cradle	-	Silver	Silver	Silver
<b>CE Marking</b>					
CE	EN 14904: 2006	-			

(1) Glued according to certificate.

DOP numbers available from your local branch.

(2) Resistant to non-colouring alcohol-based sanitisers, domestic chemicals and acid and alkaline solutions for short periods.

(3) The implementation of an effective cleaning method is the best defence against infection.

⚠ Depending on light exposure, the product color can vary, due to linoleum natural oxidization process. This process is reversible. We recommend that the samples be exposed to sunlight for several hours prior to making a final color choice.



# Linoleum Sports Floorings

## Linodur Sport

Compact Neocare™ 4 mm



1048 Country Beige



1074 Straw Yellow

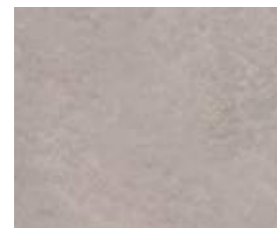

1049 Cliff Grey



1072 Peach Orange



1011 Avocado Green



1056 Marble Grey



1059 Slate Grey



1073 Glowing Rock



1026 Lagoon



1057 Heaven Blue

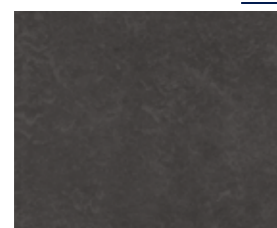

1081 Sporty Black



1013 Lava Red



1024 Speckled Blue



1020 Spring Blue

## Marmorette Sport

Compact 3,2 mm



1076 Pale Yellow



1070 Rocky Brown



1172 Papaya Orange



1048 Cranberry Red

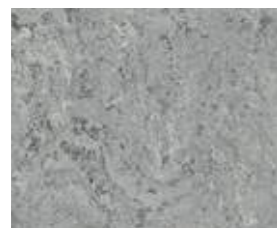

1053 Ice Grey



1050 Quartz Grey



1132 Lime Green



1026 Sky Blue

## Colorette Sport

Compact Neocare™ 4 mm



1118 Power Red



1171 Sunrise Orange



1001 Banana Yellow

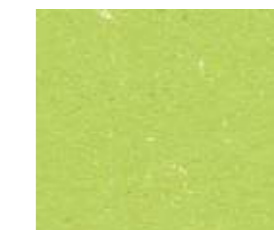

1132 Spicy Green

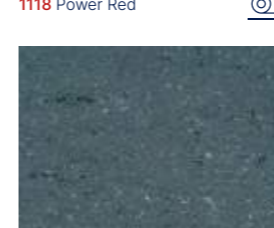

1080 Elephant Grey

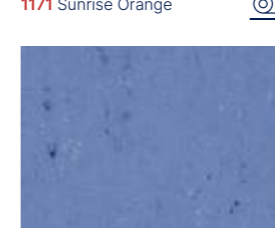

1004 Bluebird



1123 Poppy Blue



1574 Pure Green

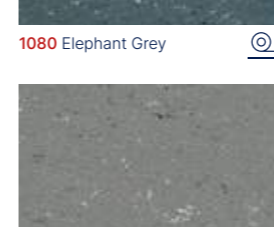

1059 Stone Grey

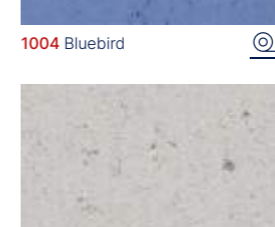

1052 Oxid Grey



1012 Light Beige

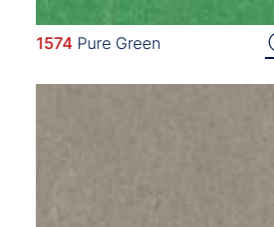

1559 Vintage Grey

## Linogym II - 10 mm

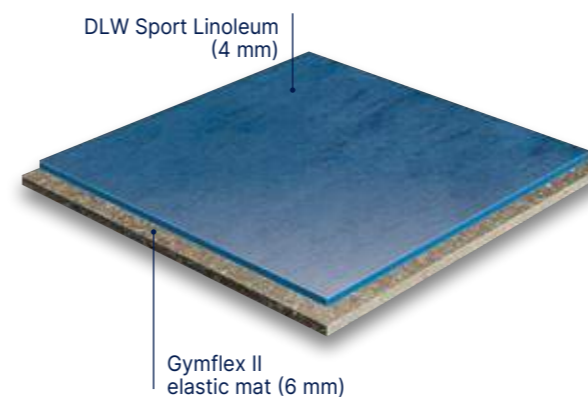

Ideally suited for kindergardens. With a 26% impact absorption rate, **LINOGYM II SYSTEM** provides outstanding cushioning qualities.

**THE LINOGYM II SYSTEM** – point-elastic flooring!

**LINOGYM II SYSTEM** brings together the best of Sport Linoleum and elastic matting. It consists of the 6 mm elastic matting Gymflex II on which a 4 mm Sports Linoleum (Linodur or Colorette) will be installed. With a 26% impact absorption rate, **LINOGYM II SYSTEM** provides outstanding cushioning qualities. The elastic matting is made of PUR foam, rubber powder and binder.



# Powershock Fitness Rubber Solutions



## High impact rubber solutions for fitness

### Powershock 80

#### Cardio & Free-weight zone

##### POWERSHOCK 80 is:

- ✓ Highly  **durable**
- ✓  **Easy to clean and maintain**
- ✓  **Highly resistant** to static loads and to dumbbells thanks to the vulcanization process of this 8 mm vulcanized rubber

Vulcanized rubber is a chemical process through high pressure and temperature enables the sulfur atoms to form links and bridges between long chains of rubber molecules. This increases the overall strength and durability of the rubber.

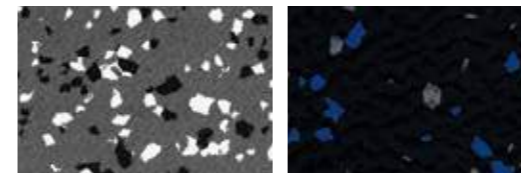

Dark Grey

Black



8 mm  
Interlocking tiles with  
dovetail edges

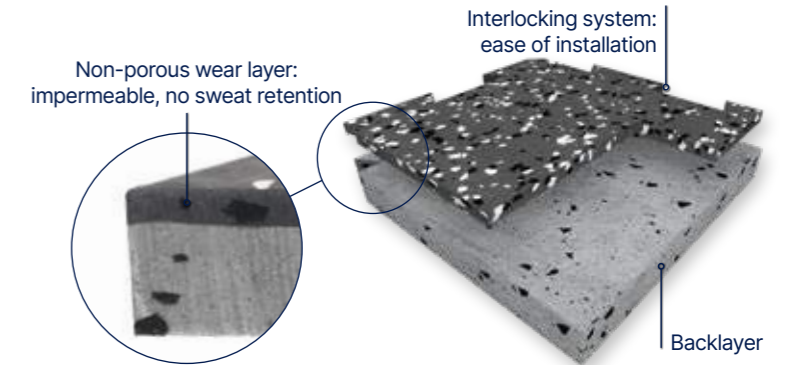

Non-porous wear layer:  
impermeable, no sweat retention

Interlocking system:  
ease of installation

Backlayer

#### Accessories

(available from Romus)



Aluminium reducer  
Unit : 3 lm



Multilevel coverstrip  
Unit : 2,7 lm

### Powershock 300

#### Crossfit & Heavy-weight area

##### POWERSHOCK 300

avoids deep-impact damage while providing an outstanding sound deadening, as well as:

- ✓ high  **shock absorption**
- ✓  **Sound insulation** of 24 dB
- ✓ great  **protection of the subfloor** being a 30 mm high impact rubber.

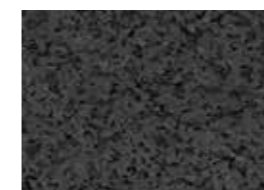

Dark Grey

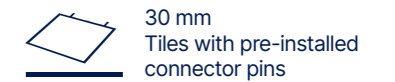

30 mm  
Tiles with pre-installed  
connector pins

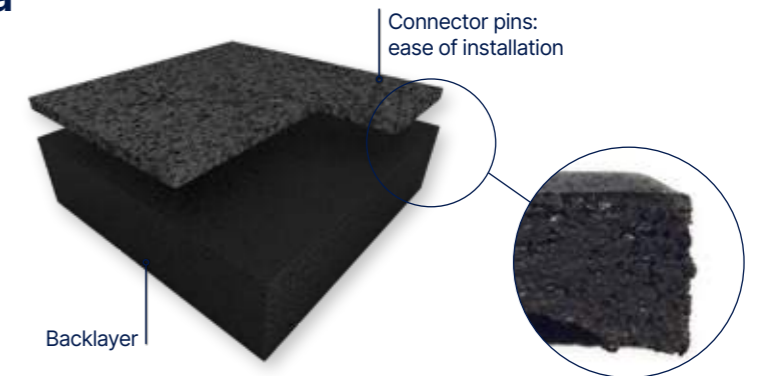

Connector pins:  
ease of installation

Backlayer

#### Accessories

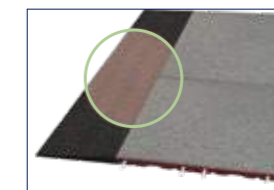

Ramp edge rubber 30 mm  
1 lm



Corner ramp edge rubber  
30 mm  
2 units (1000 x 250 mm)



# Powershock Fitness Rubber Solutions

## Technical Data

Powershock				
		300		80
		Crossfit & heavy-weight area		Cardio & free-weight area
Description				
Thickness	NF EN ISO 24346	mm	30 (± 2)	8
Weight	NF EN ISO 23997	kg/tile	6,8 (±0,2)	11,9
Size	NF EN ISO 24342	mm	500 × 500 (±0,8 %)	980 × 980 (incl. dovetails)
Classification				
Fire resistance	EN 13501-1	class	Cfl,s1	Bfl,s1
VOC	ISO 16000-6	class	A+	A+
Performance				
Dimensional stability	NF EN ISO 23999	%	< 0,1	< 0,3
Abrasion	EN ISO 5470-1	g	1,5	< 0,5
Light resistance	EN ISO 20105 - B02	level	3	4
Indentation resistance	EN 1516	mm	0,12	< 0,1
Slip resistance in dry condition	EN 13036-4	unit	80-110	80-110
Sound insulation	EN ISO 717/2	dB	24	13
Hardness shore A	Int.	-	60	> 75



# Our solutions for your fitness center

Each zone in your club has different constraints and requirements; we have solutions for each one of them.

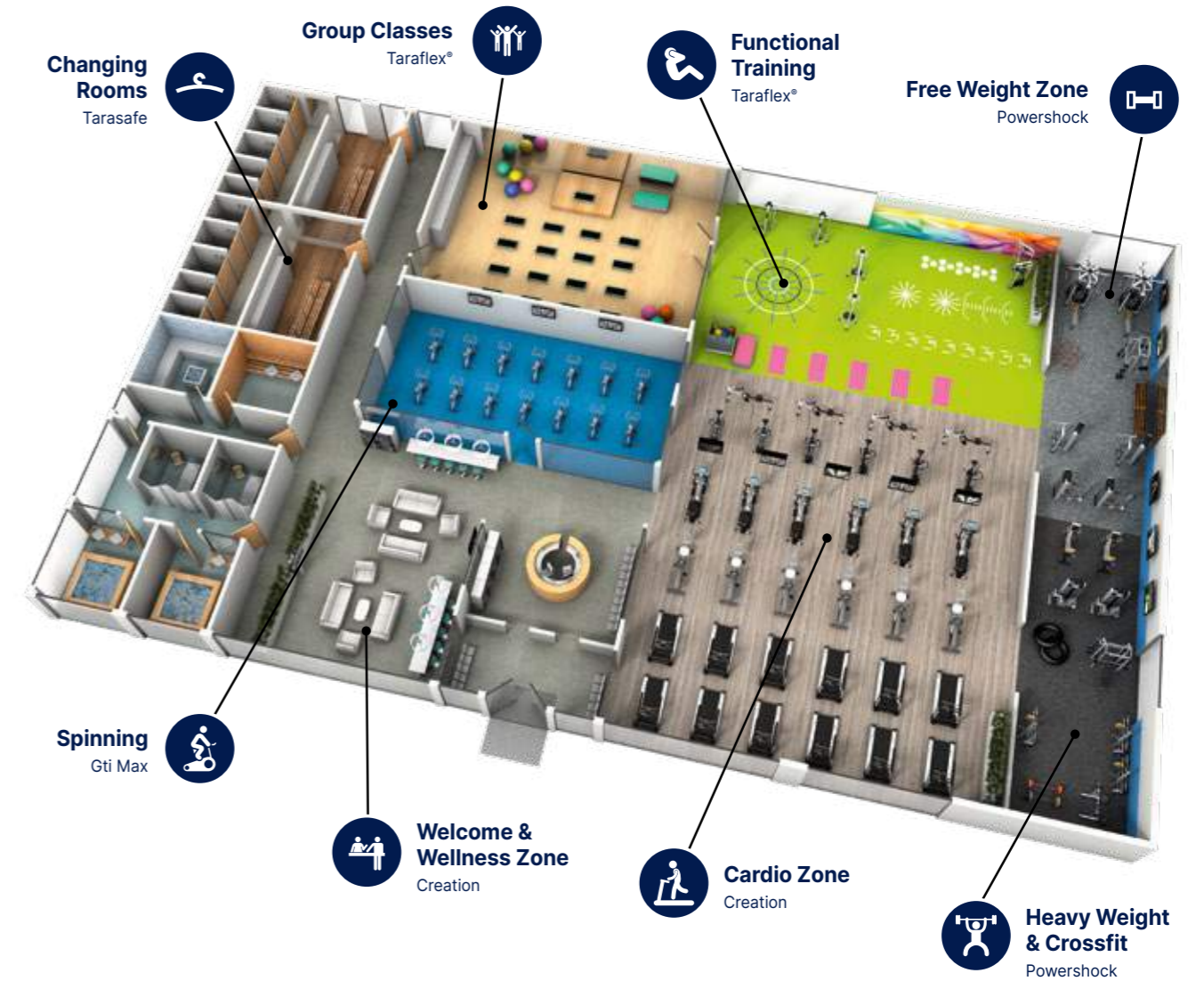

Welcome Zone



Functional Training



Spinning Zone



Cardio Zone



Group Classes



Weightlifting Zone





## Finishes

pages 372-401

**374. Finishes**

**388. Technical Solutions**

**396. Sports Finishes**

## Specifications

pages 402-409



# Finishes

- 375. Skirting and coving solutions
- 380. Stair solutions
- 382. Profile solutions
- 385. Welding solutions
- 386. Entrance solutions



## Finishes

### Skirting and coving solutions



Flexible full cove former



Full cove former  
Clip system



Capping strip



Capping strip -  
Clip system



PVC Cove former



Design skirting (MDF)



Design skirting (PVC)



Semi-rigid skirting

There are two ways of finishing the junction between the floor and wall:

- 1 Installing the PVC covering up to the edge of the wall and using a skirting insert.

**This is cost effective and time saving.**

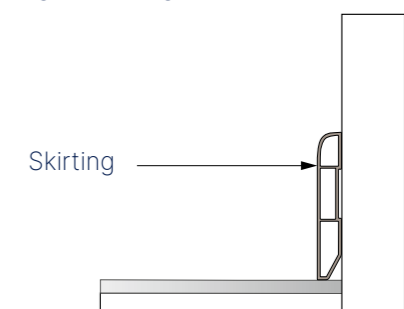

- 2 Making a cove.

**This solution makes it easier to clean inside angles and edges. It gives a waterproof connection wall/floor covering.**

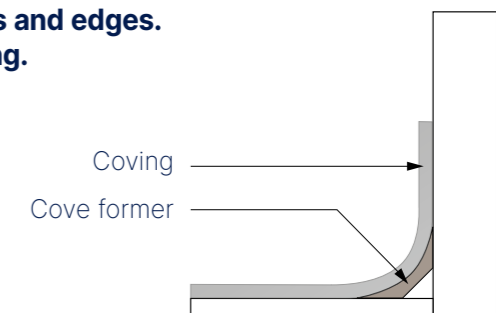

#### FOCUS

Gerflor provides a complete range of solutions including skirting, stairs, profiles and welds.













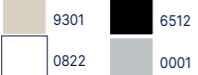
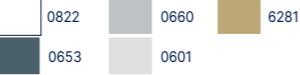

# Finishes

## Coving solutions

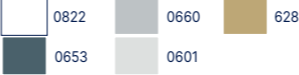
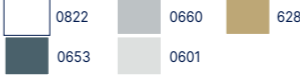
### PVC CAPPING STRIPS

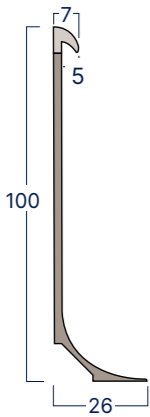
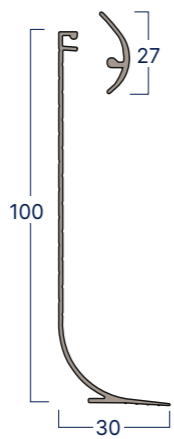
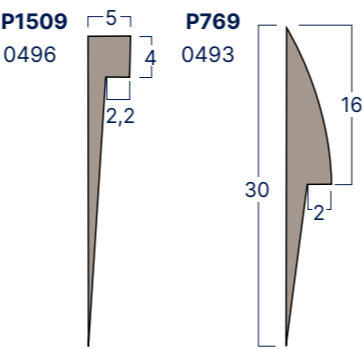
### PVC CAPPING STRIPS

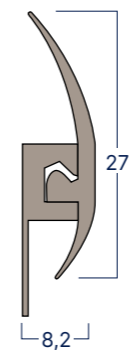
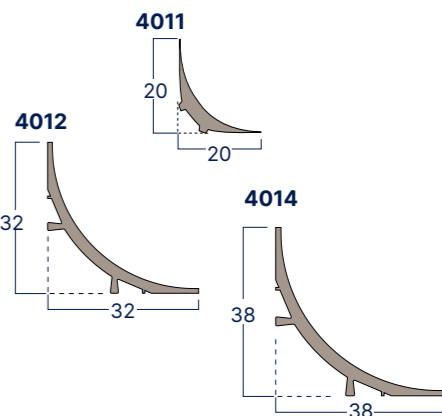



Description	 <p><b>0488</b></p> <p><b>FLEXIBLE FULL COVE FORMER</b> PVC profile combining the cover former and the capping strip into a single product.) • Adapted to the hospital sector and any room requiring a waterproof skirting</p>	 <p><b>0487</b></p> <p><b>FULL COVE FORMER CLIP-SYSTEM</b> PVC profile combining the cover former and the capping strip into a single product. • Adapted to the hospital sector and any room requiring a waterproof skirting.</p>	 <p><b>0496 0493</b></p> <p><b>P1509 / P769</b> Finishes that can be welded to the floor covering. • Do not use in commercial kitchens and showers</p>	 <p><b>0491</b></p> <p><b>CAPPING STRIPS</b> Rigid capping strip with flexible lip • Do not use in commercial kitchens and showers</p>	 <p><b>0486</b></p> <p><b>CAPPING STRIP CLIP SYSTEM</b> Rigid clipped finishing profile with 2 flexible lips • Capping strip that covers the skirting</p>	 <p><b>4011 - 4012 - 4014</b></p> <p><b>PVC COVE FORMER</b> This accessory allows the floor-wall cove to be formed</p>
Colours						
Benefits	<ul style="list-style-type: none"> <li>• Maximum floor covering thickness <b>4 mm</b></li> <li>• Guarantees <b>watertightness</b></li> <li>• <b>Quick to install</b></li> </ul>  <p><b>Packaging</b> 15 × 3 lm strips</p>	<ul style="list-style-type: none"> <li>• Maximum floor covering thickness <b>4 mm</b></li> <li>• Guarantees <b>watertightness</b></li> <li>• <b>Quick &amp; easy to install thanks to the capping strips with clip</b></li> </ul>  <p><b>Packaging</b> 20 × 3 lm strips</p>	<ul style="list-style-type: none"> <li>• P769: Adapted to 2 mm floors</li> <li>• P1509: Adapted to 2.2 mm floors</li> </ul>  <p><b>Packaging</b> 30 × 3 lm strips</p> <p><b>Packaging</b> 2 rolls of 25 lm</p>	<ul style="list-style-type: none"> <li>• Maximum covering thickness: 4 mm</li> <li>• <b>Hygienic</b></li> <li>• <b>Easy to install</b></li> </ul>  <p><b>Packaging</b> 15 × 3 lm strips</p>	<ul style="list-style-type: none"> <li>• Maximum floor covering thickness: 4 mm</li> <li>• Good watertightseal for finishing floor-wall coves and floor-wall systems notably in industrial kitchens</li> <li>• <b>Easy to install</b> thanks to the clip system</li> </ul>  <p><b>Packaging</b> 20 × 3 lm strips</p>	<ul style="list-style-type: none"> <li>• Its rounded shape <b>makes it easier to clean</b> the floor-wall junction • Propose une meilleure esthétique</li> <li>• Gives a better look</li> <li>• Limits the risk of piercing the floor covering</li> <li>• <b>Prevents accumulation</b> of dirt and bacteria</li> </ul>  <p><b>Packaging</b> 30 × 2 lm strips</p>
Tips	<ul style="list-style-type: none"> <li>• Heat the skirting with a heat gun in order to match the shape of the wall</li> <li>• Use either a double bonding adhesive, a dispersion contact adhesive or a double sided tape compatible with the PVC skirting</li> </ul>	<ul style="list-style-type: none"> <li>• Heat the skirting with a heat gun in order to match the shape of the wall</li> <li>• Use either a double bonding adhesive, a dispersion contact adhesive or a double sided tape compatible with the PVC skirting</li> </ul>	<ul style="list-style-type: none"> <li>• May also be used as a floor stopping profile</li> <li>• Weld with SG916</li> <li>• Use either a double bonding adhesive, a dispersion contact adhesive or a two-side adhesive compatible with the PVC skirting</li> </ul>	<ul style="list-style-type: none"> <li>• Slightly heat the strip if it whitens once installed</li> <li>• Use a miter shear for a perfect cut</li> <li>• Use either a double bonding adhesive, a dispersion contact adhesive or a double sided tape compatible with the PVC skirting</li> </ul>	<ul style="list-style-type: none"> <li>• Heat the profile with a heat gun (temperature about 150°C) for the installation of the external corners</li> <li>• Use a miter shear for a perfect cut</li> <li>• Use SG916 for a perfect finish of the internal corners</li> <li>• Slightly heat the profile if it whitens once installed</li> <li>• Use either a double bonding adhesive, a dispersion contact adhesive or a double sided tape compatible with the PVC skirting</li> </ul>	<ul style="list-style-type: none"> <li>• Use a mitre shear for a perfect cut</li> </ul>

Colours and images are not contractual.



# Finishes

## Skirtings

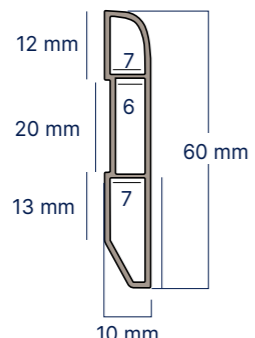
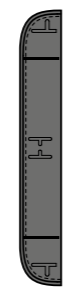
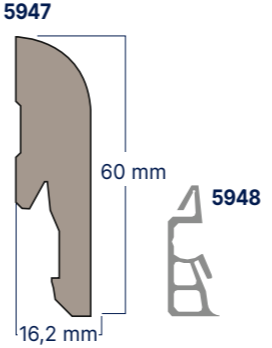
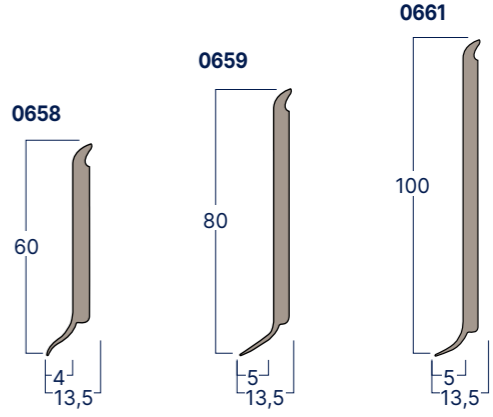
	DESIGN SKIRTING (PVC)	PVC DESIGN SKIRTING ENDCAP	PVC CAPPING STRIPS	PVC CAPPING STRIPS
<b>Description</b>	 <p><b>SKIRTING (PVC)</b> Vinyl Design Skirting for a perfect finish of Gerflor floorcoverings. 100% watertight, it could be installed in all environment.</p> <p><b>6086</b></p>	 <p><b>ENDCAP (PVC)</b> These caps allow to cover PVC Design Skirting side.</p> <p><b>6087</b></p>	<div style="display: flex; justify-content: space-around;"> <div style="text-align: center;"> <p><b>GLUE DOWN</b></p>  </div> <div style="text-align: center;"> <p><b>INTERLOCKING</b></p>  </div> </div> <p style="text-align: center; margin: 0 10px;"><b>Or</b></p> <p><b>SKIRTING (MDF)</b> MDF Design Skirting for a perfect finish of Gerflor floorcoverings.</p> <p><b>5947</b></p>	 <p><b>VYNAFLEX</b> Semi-rigid PVC skirting to be placed on the wall</p> <p><b>60 mm : 0658 / 80 mm : 0659 / 100 mm : 0661</b></p>
<b>Colours</b>		<p>Anthracite grey 0001</p>	<p>Blanc 0822 Noir 6512 Gris 0430</p> <p>Miel 0455 Taupe 0456</p>	
<b>Benefits</b>	<ul style="list-style-type: none"> <li>Thin and discrete, it ensures an elegant finish and hides the dilatation gaps</li> <li>Designs of the Creation 30, Creation 55 and Rigid 30 collections are available</li> <li>Some Creation 70 designs are available</li> <li>The skirting is also available in a paintable white version</li> </ul>  <p><b>Packaging</b> 6 x 2 m</p>	<ul style="list-style-type: none"> <li>PVC cap, aluminum color, fits all our PVC Design Skirtings</li> <li>Can be used for one side of the skirting or the other</li> </ul>  <p><b>Packaging</b> Bag of 10 reversible caps</p>	<ul style="list-style-type: none"> <li>Available in all designs of Creation 30, Creation 55, Top Silence and Rigid collection</li> <li>Some Creation 70 designs are available</li> <li>It ensures an elegant finish and hides the dilatation gaps</li> <li>The skirting is also available in a paintable white version</li> </ul>  <p><b>Packaging</b> 5947: 5 x 2.2 m 5948: 1 box of 30 clips</p>	<ul style="list-style-type: none"> <li>Solid colour</li> <li>Resistant to washing waters</li> </ul>  <p><b>Packaging</b> 0658 / 0661: 25 format (3lm) 0659: 32 format (3lm)</p>
<b>Tips</b>	<ul style="list-style-type: none"> <li>Use a wood saw with fine teeth</li> <li>Use a mitre box for the corner</li> <li>Do not screw or nail</li> <li>For more information contact the customer service</li> </ul>	<ul style="list-style-type: none"> <li>Cut one end, glue it, press it</li> </ul>	<ul style="list-style-type: none"> <li>Use a wood saw with fine teeth</li> <li>Use a mitre box for the corner</li> <li>For more information contact the customer service</li> </ul>	<ul style="list-style-type: none"> <li>Use skirting corner Cutter to handle internal and external angles</li> <li>Use either a double bonding adhesive, a dispersion contact adhesive or a double sided tape compatible with the PVC skirting</li> <li>Apply an adhesion primer if the sub-floor is porous</li> </ul>

Colours and images are not contractual.



# Finishes

## Stair solutions

Gerflor has developed 2 solutions for installing a Vinyl floor on stairs to complement its range of floors:

### 1 Tarastep

- Install the base of the finishing clip onto the flat angle of the stair
- Install the Tarastep
- Clip the stair clip system

**Adapted to rounded stair nosing.**

**Mill the angle for straight stair nosing.**

**For bird's beak stair nosing, fill the void beforehand.**

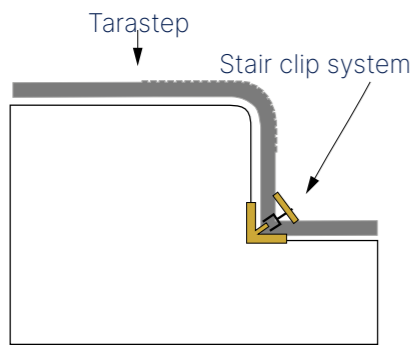
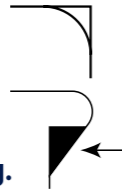



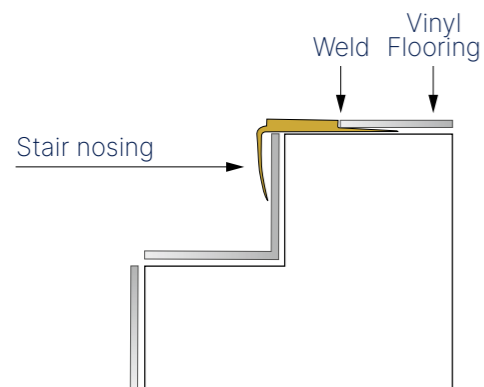

### 2 Stair nosing insert

- Install the vinyl flooring and the stair nosing by starting at the bottom of the stair
- Install the riser
- Install the stair nosing
- Install the flat of the stair
- Weld

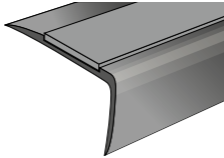
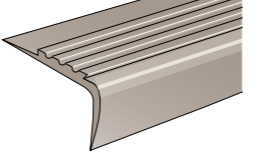
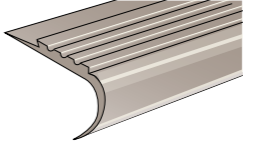
**Adapted to straight stair nosing, rounded stair nosing and bird's beak stair nosing.**

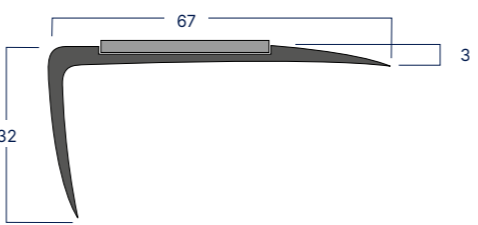
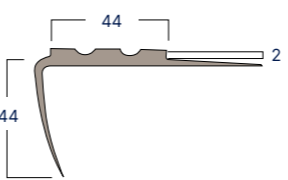
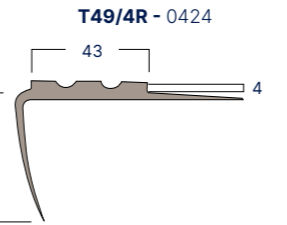
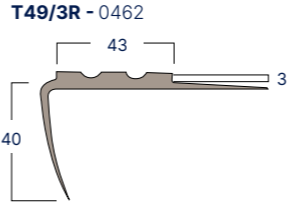
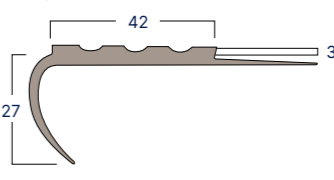

	STAIR NOSING INSERT	STAIR NOSING INSERT	STAIR NOSING INSERT
<b>Description</b>	 <p>ALUMINIUM STAIR NOSING T67 ALU</p> <ul style="list-style-type: none"> <li>• Landing/stair harmony</li> <li>• Guarantees floor covering durability</li> </ul> <p>0503</p>	 <p>GROOVED PVC STAIR NOSING T49/4R - T49/3R - T49/2R Straight angles</p> <p>0424 - 0462 - 0461</p>	 <p>GROOVED PVC STAIR NOSING T27/3R Rounded angles and bird's beak</p> <p>0467</p>
<b>Colours</b>	 0001		
<b>Benefits</b>	<ul style="list-style-type: none"> <li>• For a state-of-the-art stair finish</li> <li>• Delivered with a black strip made out of carborandum for an improved anti-sliping action of the stair nosing</li> </ul>  <p><b>Packaging</b> 10 × 3 lm strips + 10 carborandum strips</p>	<p>T49/4R - T49/3R - T49/2R</p> <ul style="list-style-type: none"> <li>• Adapted to 2, 3 or 4 mm floor covering</li> <li>• Weldable</li> </ul> <p>T49/2R - 0461</p>  <p>T49/4R - 0424</p>  <p>T49/3R - 0462</p>  <p><b>Packaging</b> 10 × 3 lm strips</p>	<p>T27/3R</p> <ul style="list-style-type: none"> <li>• Adapted to 3 mm floor covering</li> <li>• Weldable</li> </ul> <p>T27/3R - 0467</p>  <p><b>Packaging</b> 10 × 3 lm strips</p>
<b>Tips</b>	<ul style="list-style-type: none"> <li>• Secure with flat head cross head countersunk stainless steel screws (not included)</li> </ul>	<ul style="list-style-type: none"> <li>• Do not apply adhesive to the vertical part of the stair nosing</li> <li>• Double bonding</li> </ul>	

Colours and images are not contractual.



# Finishes

## Profile solutions

Our profiles provide solutions to several problems concerning links between floors, walls or bare spots depending on the flooring thickness and technical requirements.



Diminishing profile



Connection profile



Aluminium coverstrip



Ramp edges



Aluminium profiles

They in particular, allow two types of connections to be dealt with:

### 1 Connecting profiles

The connections between two floor coverings

- Floor/Floor
- Floor/wall

**Allow the link between two floor coverings with different thicknesses.**

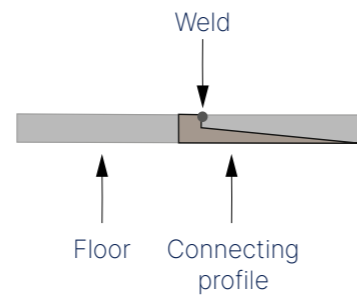

### 2 Ramp edges

The vinyl floor/bare spot connections

**Protect the edging and prevent the floor covering from delaminating.**

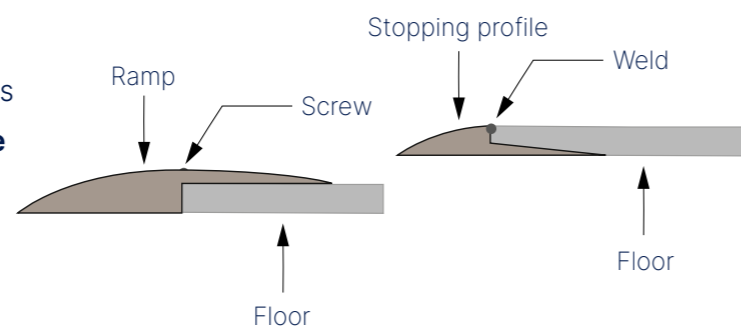

## PVC profiles









	FLOOR TO WALL CONNECTING PROFILE	FLOOR TO FLOOR CONNECTING PROFILE	RAMP EDGES
Description	 <p><b>0490</b></p> <p><b>DIMINISHING PROFILE</b></p> <ul style="list-style-type: none"> <li>▸ Coving/wall covering connection</li> <li>▸ Used in laboratories, hospital shower systems, commercial kitchens</li> </ul>	 <p><b>0496</b></p> <p><b>P1509</b></p> <ul style="list-style-type: none"> <li>▸ These products allow the link between two-floor coverings to be made</li> </ul>	 <p><b>0493</b></p> <p><b>P769</b></p> <ul style="list-style-type: none"> <li>▸ Connect other surfaces and vinyl floors</li> </ul>
Colours	 <p>Noir 6512</p>	 <p>Noir 6512 Gris 4203</p>	 <p>Noir 6512 Gris 4203</p>
Benefits	<ul style="list-style-type: none"> <li>▸ Makes it easier to link the floor covering and wall</li> <li>▸ <b>Hygienic.</b> Avoids bacteria accumulation</li> <li>▸ <b>Prevents the</b> floor covering from <b>tearing</b>, improves <b>durability</b> and ensures <b>watertightness</b></li> </ul> 	<ul style="list-style-type: none"> <li>▸ Junction between two floors of 2.2 mm and 5 mm</li> <li>▸ Floor covering can be welded to profile to create a watertight seal</li> <li>▸ <b>Can also be used as a finishing profile</b></li> </ul> 	<ul style="list-style-type: none"> <li>▸ Floor covering <b>welding</b> system</li> <li>▸ Suitable for 2 mm floors</li> <li>▸ Ensures watertight seal</li> <li>▸ Can also be used as a capping strip</li> </ul> 
Tips	<p><b>Packaging</b> 2 rolls of 25 lm</p> <ul style="list-style-type: none"> <li>• Bonding with acrylic adhesive</li> </ul>	<p><b>Packaging</b> 30 × 3 lm strips</p> <ul style="list-style-type: none"> <li>• Polychloroprene double bonding</li> </ul>	<p><b>Packaging</b> 2 rolls de 25 lm</p> <ul style="list-style-type: none"> <li>• Double bonding</li> </ul>

Colours and images are not contractual.



# Finishes

## Aluminium Ramp Edges

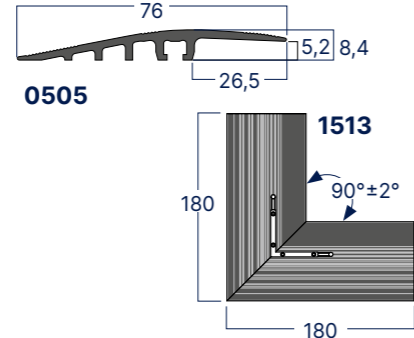
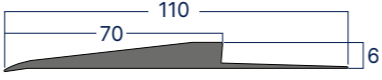
	SCREWED	LOOSELAY	
Description	 <p>ALUMINIUM RAMP 2.8 MM</p> <ul style="list-style-type: none"> <li>Access ramps resistant to high traffic and humidity</li> </ul>	  <p>ALUMINIUM RAMP 5-6 MM</p> <p>ALUMINIUM CORNER 5-6 MM</p>	 <p>PVC RAMP 6 MM</p>
Colours	 0001	 0001	 0001 0002
Benefits	<p>Product suitable for floor coverings of:</p> <ul style="list-style-type: none"> <li>2-3 mm (Creation 70, Creation 55, Creation 30, ...)</li> </ul>  <p>0504</p> <p><b>Packaging</b> 10 x 3 lm ramps</p>	<ul style="list-style-type: none"> <li>Smooth shape for more utilisation comfort</li> <li>Connectors for a perfect connection of 2 profiles</li> <li>Pre-assembled corners for an easier installation and a perfect finish</li> </ul> <p>Products suitable for floor coverings of:</p> <ul style="list-style-type: none"> <li>5-6 mm (Attraction®, GTI® MAX, Creation 70 Clic, Creation 55 Solid Clic, Creation 30 Solid Clic, ...)</li> </ul>  <p>0505</p> <p>1513</p> <p><b>Packaging</b> 5 x 3 lm ramps (0505) / 4 corners (1513)</p>	<ul style="list-style-type: none"> <li>Product suitable for floor coverings of 6mm (GTI®)</li> <li>Easy to install &amp; and no floor damage : time saving</li> <li>Unbreakable &amp; less scratches : fewer replacing costs</li> <li>Easy to cut</li> </ul>  <p>0500</p> <p><b>Packaging</b> 8 lengths x 2 lm / box</p>
Tips	<ul style="list-style-type: none"> <li>Delivered with fixation kit</li> <li>Screwing of the ramp to the floor with flat cross head countersunk stainless steel screws (Aluminium ramp 5-6 mm and aluminium corner)</li> </ul>	<ul style="list-style-type: none"> <li>Looselay installation without damaging the subfloor (looselay ramp)</li> </ul>	

## Welding solutions

	HOT WELD
Description	 <p>WELDING RODS</p> <ul style="list-style-type: none"> <li>This is used for all types of PVC floors, for coving sport floors</li> <li>Ensures a complete watertight seal</li> </ul> <p><b>Gerflor has a large range of rods available</b> Ø 4 mm / Ø 4.1 mm / Ø 5 mm / Ø 6 mm</p>  <p>The welding rod is placed in the chamfer between two floor coverings. When heated, it melts and fills the entire space to ensure complete watertight seal.</p>
Benefits	<p>WELDING ROD AND FLOORING MATCHING TOOL <a href="http://www.gerflor.com/servicesprofessionals/welding-rods-matching.html">http://www.gerflor.com/servicesprofessionals/welding-rods-matching.html</a></p>  <p>Product suitable for floor coverings of:</p> <ul style="list-style-type: none"> <li>CR40: Floor/floor weld - Code 0585</li> <li>CR50: Welding of sport floors - Code H209</li> </ul> <p><b>Specific weld rods</b></p> <ul style="list-style-type: none"> <li>CR50: Weld, Tarasafe Plus, floor repairs on special order - Code H009</li> <li>CA72: Triangular rod for commercial kitchen floor to base welding - Code H007</li> <li>CR60: Welding of sport floors, repair on special order - Code H011</li> <li>BBR40: 100% Bio-based plasticizer rod for Mipolam Symbioz</li> <li>MCR40: Multicolor rod for Mipolam Accord &amp; Affinity - Code H058</li> </ul> <p><b>Packaging</b> CR40, BBR40, CR50, CA72: 100 lm. coil CR60: 60 lm. coil MCR40: 50 lm. coil</p> <p><i>Please contact us for further information on weld rods</i></p>
Tips	<ul style="list-style-type: none"> <li>For a better weld the correct grooving should be performed.</li> <li>Use an adapted nozzle (Ultra Speed Nozzle).</li> </ul>

Colours and images are not contractual.



# Finishes

## Entrance Solutions

Three cleaning zones to be covered at the entrance to a building

Each zone has a specific "cleaning" role:



### Zone 1



Ribbed Rubber Insert

**Romat**  
Frequent traffic (500 p/day)

**Romat GT**  
Heavy traffic (500 to 2,000 p/day)

**Reversible**  
Intensive traffic (> 2,000 p/day)

### Zone 2

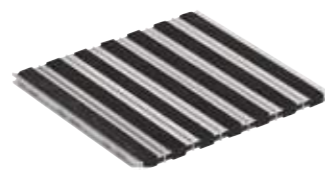

Textile Insert

**Romat**  
Frequent traffic (500 p/day)

**Romat GT**  
Heavy traffic (500 to 2,000 p/day)

Rubber Grate Insert

**Romat reverse**  
Intensive traffic (> 2,000 p/day)

### Zone 3



Dirt-Trapping Mat

**Ronet**  
Frequent traffic (500 p/day)

**Roclean**  
Heavy traffic (> 500 p/day)

## Entrance Mats

- ▶ Eliminate dust, moisture and other residue from visitors' feet as efficiently as possible at the entrance of a building.
- ▶ Prevent premature soiling and wear of floor coverings.

### LOOSELAY ROMAT GT - INSERT KIT



Ref. 1719 - 1.5 × 1 m

#### For pedestrian traffic only.

Entrance mat affording floors of buildings efficient and sustainable protection from pedestrian traffic by forming a barrier to outside dirt. Thanks to its loose-lay installation, the mat can be installed without damaging the surface. Adapted for an important pedestrian traffic (up to 2000 people per day).

#### This kit contains:

- ▶ 1 mat
- ▶ 4 frames composed of 4 lower and 4 upper profiles
- ▶ 4 external pre-assembled corners
- ▶ 60 5-7 screws
- ▶ 1 Installation guideline

### KIT ESPLANADE 9000



Ref. 1700 - 1.5 × 1.5 m

Kit for the incrustation of an ESPLANADE 9000 mat in an area covered with Attraction®, GTI®, Creation 55 Solid Clic, Creation 70 Clic. The closed conception of the mat enable to scratch the underside of shoes and increase the durability of the floors. It resists to intense pedestrian traffic (up to 5000/day) and to mecanial traffic.

- ▶ Packaging: 2.5 sqm kit: 3 mats modules, 4 upper and 4 lower profiles, screws.



# Technical Solutions

## 389. Accessibility

## 390. LVT Underlayers

## 392. Specific products

- 393. Isolating membranes
- 393. ESD copper strip

## 394. Adhesives and tapes



# Technical Solutions

## Accessibility

### WARNING SURFACES

ALERTILE, SELF-ADHESIVE OR WELDABLE TACTILE SLAB

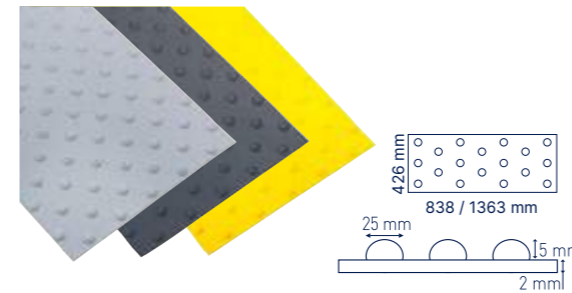

Dimensions: 426 x 1363 mm / 426 x 838 mm  
 Packaging: 8 units per box (838 mm)  
 4 units per box (1363 mm)  
 Codes: 059B (838 mm) / 059A (1363 mm)

EASYPLOT, THE AESTHETIC SOLUTION FOR WARNING



Packaging: Kit of 198 studs (6 planks de 33 studs)  
 approx. 1.3 m x 0.4 m  
 Codes: 059C (Grey, Black) - 059D (Alu)

### GUIDING

EASYGUIDE, THE SELF-ADHESIVE SOLUTION FOR GUIDING



Packaging: Box of 6 slabs 300 x 220 mm (4 bars/slab) for 1.8 m of guideline  
 Code E219

### SIGNAGE

Personalised cut-to-size system



### FOCUS

Gerflor offers a full range of technical solutions such as the shower system, copper strips, adhesives or tools in order to provide all the technical requirements on site.



# Technical Solutions

## LVT Underlayers

	CREATION 30/40/55 SOLID CLIC & CREATION 70 CLIC	CREATION 40/55 SOLID CLIC - HOME CLIC	CREATION 70 CLIC + 30/40/55 SOLID CLIC	CREATION 30/40/55
Description	<p>GERFLOR ACOUSTIC 15 DB</p>  <p><b>1798</b></p> <ul style="list-style-type: none"> <li>Sound absorption underlay in roll</li> </ul>	<p>GERFLOR SILENCE PLUS 19 DB</p>  <p><b>5949</b></p> <ul style="list-style-type: none"> <li>Sound absorption underlay in accordion</li> </ul>	<p>GERFLOR ACOUSTIC PLUS 19 DB</p>  <p><b>0704</b></p> <ul style="list-style-type: none"> <li>Sound absorption underlay in roll</li> </ul>	<p>GERFLOR SMART FIX 16 DB</p>  <p><b>1698</b></p> <ul style="list-style-type: none"> <li>Underlay with self-adhesive surface</li> <li>Sound absorption underlay in roll</li> </ul>
Benefits	<ul style="list-style-type: none"> <li>Reduces impact noise up to <b>15 dB</b></li> <li>Adapted to the same traffic than the LVT but semi-industrial or industrial application</li> <li>Thickness: <b>0.93 mm</b></li> </ul> <p><b>Packaging</b> 1798 - 1 x 15 lm = 15 sqm</p>	<ul style="list-style-type: none"> <li>Reduces impact noise up to <b>19 dB</b></li> <li>Adapted to the same traffic than the LVT but semi-industrial or industrial application</li> <li>Thickness: <b>1.5 mm</b></li> </ul> <p><b>Packaging</b> 5949 - 1.18 x 8.5 lm = 10 sqm</p>	<ul style="list-style-type: none"> <li>Reduces impact noise up to <b>19 dB</b></li> <li>Adapted to the same traffic than the LVT but semi-industrial or industrial application</li> <li>Thickness: <b>1.2 mm</b></li> </ul> <p><b>Packaging</b> 704 - 0,98 x 15,3 lm = 15 sqm</p>	<ul style="list-style-type: none"> <li>For a loose lay installation of LVT dry back.</li> <li>Reduces impact noise up to <b>16 dB</b></li> <li>Adapted to the same traffic than the LVT but semi-industrial or industrial application</li> <li>Thickness: <b>2 mm</b></li> </ul> <p><b>Packaging</b> 1 x 7.5 lm = 7.5 sqm</p>
Tips	<ul style="list-style-type: none"> <li>Underlay is rolled on reverse</li> <li>Refer to technical installation guidelines to check the approved products</li> </ul>	<ul style="list-style-type: none"> <li>Printed side on top</li> <li>Refer to technical installation guidelines to check the approved products</li> </ul>	<ul style="list-style-type: none"> <li>Unroll the underlay</li> <li>Refer to technical installation guidelines to check the approved products</li> </ul>	<ul style="list-style-type: none"> <li>Fleece side: on the subfloor</li> <li>Adhesived side: under the LVT</li> <li>Refer to technical installation guidelines to check the approved products</li> </ul>



# Technical Solutions

## Specific Products

Gerflor offers a set of products providing solutions to specific problems such as accessibility, insulation, maintenance of floors and electrical conductivity of our floors.



ISOLATING MEMBRANES



ESD COPPER STRIP



WATERTIGHT



RESISTANT & DURABLE



CLEAN

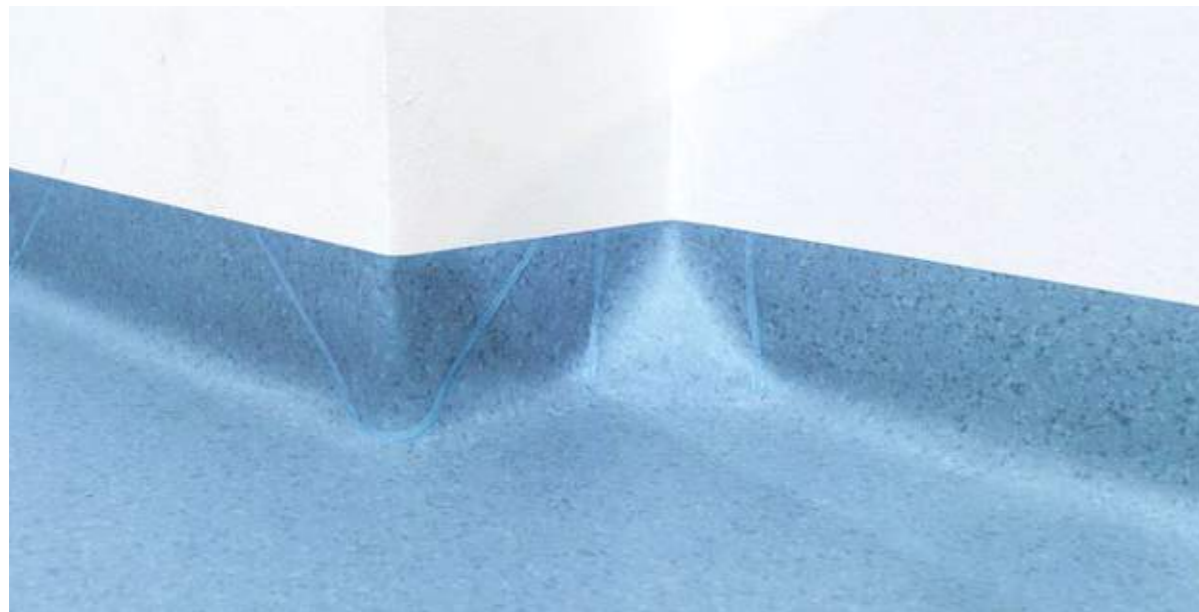

CLEAN CORNER SYSTEM FOR ALL GERFLOR FLOORS

	ISOLSPORT	TARAFOAM	COPPER STRIP
Description	 <p><b>0829 0002</b> VINYL ISOLATING MEMBRANE <b>Specially designed for sports</b> For installation on concrete subfloors</p>	 <p><b>997C 6792</b> COMFORT VERSION OF THE SHOWER SYSTEM</p>	 <p><b>0586 0001</b> ESD COPPER STRIP Copper strip enabling earthing</p>
Benefits	<ul style="list-style-type: none"> <li>• Vinyl isolating membrane, double side on non woven glass fibre with backing design made up of 3-branch star foam pads.</li> <li>• Its design enables loose laying on sensitive subfloors (risks of humidity, coated, etc.) when it is associated with a Taraflex® sporting floor. The raised effect allows humidity to circulate.</li> <li>• Thickness: 1.7 mm</li> </ul>	<ul style="list-style-type: none"> <li>• Provides <b>acoustic insulation for the shower system</b> (15 dB) and comfort under foot.</li> <li>• Thickness: 2 mm</li> </ul>	<ul style="list-style-type: none"> <li>• For electro-conductive floor coverings such as Elegance EL5, Technic EL5, GTI® EL5, Affinity EL7, Robust EL7</li> <li>• Width 10 mm, thickness 0.08 mm</li> </ul>
Packaging	<p><b>Packaging</b> 1 × 45 lm roll</p>	<p><b>Packaging</b> Roll of 2 m x 20 lm - 40 m<sup>2</sup></p>	<p><b>Packaging</b> 1 × 200 lm roll</p>
Tips	<ul style="list-style-type: none"> <li>• Bond well at doors with PU adhesive to prevent delamination.</li> <li>• Keep the raised surface, floor side, on the periphery</li> <li>• Edge to edge installation</li> </ul>	<ul style="list-style-type: none"> <li>• Levels out around the edge of the room</li> <li>• Acrylic bonding</li> <li>• Edge to edge installation</li> </ul>	<ul style="list-style-type: none"> <li>• Prevent discontinuity between the angles by folding it back onto itself</li> </ul>

Colours and images are not contractual.



# Technical Solutions

## Adhesives and Tapes

Gerflor has developed specific bonding solutions to make it easier to install its products.

	ADHESIVES	HOOK & LOOP AND DOUBLE SIDED TAPE FOR TEXTILE BACKING	hop HOLDING TAPE <b>New</b>	NON-MIGRATING DOUBLE SIDED TAPES	
Description	<p>GERPUR</p>  <p><b>086C 0083</b> Specially designed for sports Only for Dry Tex™ System (bonding of Taraflex sport floors with non-woven backing)</p>	<p>D75</p>  <p><b>0534 0001</b></p>	<p>hop HOLDING TAPE</p>  <p><b>059E0001</b></p>	<p>FIX&amp;FREE 100</p>  <p><b>058U 0001</b></p>	<p>FIX&amp;FREE 740</p>  <p><b>058W 0001</b></p>
			Width: 75 mm	Width: 96 mm	Width: 100 mm
Benefits	<ul style="list-style-type: none"> <li>• Bonding on new and old humid concrete subfloor</li> <li>• Mono component PU adhesive, reactive to humidity which enables the DTX material to be fully bonded in humid environment (no restriction of humidity levels with the exception of surface water)</li> <li>• Consumption: 400 to 450 g/m<sup>2</sup></li> </ul>	<ul style="list-style-type: none"> <li>• D75 enables installation of vinyl floor coverings with textile backing on the perimeter and under joints.</li> <li>• Time saving and cleanliness by comparison with a bonded system.</li> <li>• No gumming time and no smell.</li> </ul>	<ul style="list-style-type: none"> <li>• Reinforced tape : durable</li> <li>• Easy to position</li> <li>• No transfer to surface underneath</li> <li>• Easy to remove without damaging the support</li> <li>• Makes welding easier</li> </ul>	<ul style="list-style-type: none"> <li>• New double-sided tapes in order to install and uninstall our floorcovering easily, without damaging the subfloor. This is particularly useful for "ephemeral areas" (in retail for instance) of for renovation of subfloor containing asbestos.</li> <li>• Fix&amp;Free 100 is suitable for textile backing floorcovering.</li> <li>• Fix&amp;Free 740 is suitable for Creation Clic and GTI®.</li> <li>• Time saving and cleanliness by comparison with a bonded system.</li> <li>• No gumming time and no smell.</li> </ul>	
	<p><b>Packaging</b> 15 kg bucket</p>	<p><b>Packaging</b> 1 × 25 lm roll</p>	<p><b>Packaging</b> 1 × 50 lm roll</p>	<p><b>Packaging</b> 1 × 50 lm roll</p>	<p><b>Packaging</b> 1 × 25 lm roll</p>
Tips	<ul style="list-style-type: none"> <li>• To be applied with ergonomic trowel for rigid adhesive and B1 blade</li> </ul>				

Colours and images are not contractual.



# Sports Finishes

- 397. Marking
- 398. Specific Products
- 400. Adhesives and Tapes
- 401. Tools - Sport



## FOCUS

We provide finishing solutions suitable for sports floor coverings such as permanent or temporary line marking solutions.

# Sports Finishes

## Marking



### PERMANENT GAME LINES (PAINT)

Description	Article code	Components
KIT TLD AQUA BASKET	085V0001	4 red paint's can, 4 hardener's can, 9 adhesive tapes and 1 roller
KIT TLD AQUA BADMINTON	085W0001	3 black paint's can, 3 hardener's can, 7 adhesive tapes and 1 roller
KIT TLD AQUA TENNIS	085X0001	3 white paint's can, 3 hardener's can, 7 adhesive tapes and 1 roller
KIT TLD AQUA HANDBALL	085Y0001	4 yellow paint's can, 4 hardener's can, 9 adhesive tapes and 1 roller
KIT TLD AQUA VOLLEY	085Z0001	2 blue paint's can, 2 hardener's can, 3 adhesive tapes and 1 roller

### TEMPORARY GAME LINES (TAPE)

Description	Article code	Use
3M TAPES BLACK (**)	H1970002	For game lines
3M TAPES WHITE (**)	H1970004 (*)	For game lines - White = Tennis
3M TAPES RED (**)	H1970005	For game lines - Red = Basket
3M TAPES BLUE (**)	H1970006	For game lines - Blue = Volley



### GAME LINE EQUIPMENT (PERMANENT & TEMPORARY)

Description	Article code	Use
GAME LINE MARKING DEVICE	087W0001	Circular line marking of up 9 m radius can be achieved with this device.
GAME LINE MARKING DEVICE AND CIRCLE CUTTER	087X0001	<p><b>COMPONENTS</b></p> <ul style="list-style-type: none"> <li>① Marking head with 50 mm adhesive marking tape</li> <li>② Marking head with 19 mm protective tape</li> <li>③ Extension poles</li> <li>④ Pole-connections</li> <li>⑤ Centre-part with 2 suction cups</li> <li>⑥ Sheet metal guides for straight lines</li> <li>⑦ Transporting case ABS</li> <li>⑧ Case for extension poles</li> </ul> <p>Circle cutter (optional for only 087X0001)</p>

(\*) White color can be used for any other monosport court.  
 (\*\*) To be installed on Taraflex® Range except on portable embossing.

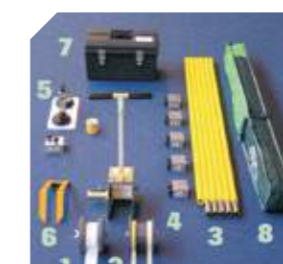

Game Line Marking Device







Circle Cutter



# Sports Finishes

Specific Products / Isolating membrane & cleaning detergents

Specific Products / Cleaning detergents

	BATECO	SPORT FLOOR MAINTENANCE		PROTECSOL® FLOOR MAINTENANCE	
<b>Description</b>	 <p><b>H3756801 (customized lengths)</b>  <b>HM126801 (standard lengths at 20 lm)</b>  <b>HM066801 (standard lengths at 30 lm)</b></p> <p>PROTECTIVE SURFACE</p> <p><b>Specially designed for sports</b>            Suitable for gymnasium / reception hall versatility</p>	 <p><b>085P 0001</b>            TRACIFLEX</p> <ul style="list-style-type: none"> <li>• Multipurpose detergent for cleaning the vinyl sport floors (shoe marks and contact marks)</li> <li>• Also suitable for floors which are difficult to clean</li> <li>• For daily or weekly maintenance</li> </ul>	 <p><b>085E 0001</b>            TANEX TROPHY</p> <ul style="list-style-type: none"> <li>• Multipurpose detergent for cleaning the vinyl sport floors (shoe marks and contact marks)</li> <li>• Also suitable for floors which are difficult to clean</li> <li>• For weekly maintenance</li> </ul>	 <p><b>085A 0010</b>            SPRAY TARACLEAN</p> <ul style="list-style-type: none"> <li>• Spray cleaner to remove occasional and tough stains, notably resin marks</li> </ul>	
<b>Benefits</b>	<ul style="list-style-type: none"> <li>• <b>Protective surface</b> made from black calendered and grained plasticised vinyl.</li> <li>• Taraflex Bateco is especially designed to protect sport floors in the event of non-sports use of the room. It prevents marking by chairs, tables, heels on the sport floor.</li> <li>• Thickness: 1.5 mm</li> </ul> <p><b>Packaging</b>            1 × 20 lm roll / 1 × 30 lm roll</p>	<ul style="list-style-type: none"> <li>• Removes resin from Handball courts</li> <li>• Recommended in sport room</li> </ul>  <p><b>Packaging</b>            1 l can</p>		<ul style="list-style-type: none"> <li>• For all sport floors</li> </ul> <p><b>Packaging</b>            2 cans of 5 L, for a total of 10 L</p>	<ul style="list-style-type: none"> <li>• Suited to all types of floors treated with Protecso!®</li> <li>• Easy and quick to use</li> </ul> <p><b>Packaging</b>            unit</p>
<b>Tips</b>	<ul style="list-style-type: none"> <li>• Edge to edge installation</li> <li>• Strips can be secured with single-sided adhesive tape AT7</li> </ul>	<ul style="list-style-type: none"> <li>• Traciflex may be sprayed on stubborn stains</li> </ul>			

Colours and images are not contractual.



### DOUBLE SIDED TAPES FOR SPORT FLOORS

Description	AT7	TARAFIX SL
<p>ADHESIVE TAPE FOR SMOOTH SURFACES</p>  <p><b>H1050001</b></p> <p>DOUBLE-SIDE TAPE FOR SMOOTH SURFACES LIKE VARNISHED PARQUET OR PVC SPORTS FLOORS</p>	 <p><b>H206 0001</b></p> <p>SINGLE-SIDE TAPE</p>	 <p><b>06480001</b></p> <p>HOLDING STRIPS FOR TARAFLEX® SL SOLUTIONS</p>
Width: 96 mm	Width: 100 mm	Width: 96 mm
<p>Adapted to temporary installation</p> <p>Requires a test on site for validation</p>	<p>Black</p> <p>Bonds without leaving marks, non migrating</p> <p><b>Holds strips:</b></p> <ol style="list-style-type: none"> <li>During non sportive events</li> <li>Enables the material to be secured on the tube at the time of winding</li> <li>Holds strips during the storage time</li> </ol>	<p>Reinforced tape : durable</p> <p>Easy to position</p> <p>No transfer to surface underneath</p> <p>Easy to remove without damaging the support</p> <p>Makes welding easier</p>
<p><b>Packaging</b></p> <p>0.096 × 45 lm roll (96 mm x 45 m)</p>	<p><b>Packaging</b></p> <p>0.1 × 33 lm roll (100 mm x 33 m)</p>	<p><b>Packaging</b></p> <p>0.096 × 25 lm roll</p>
<p>Required material:</p> <ul style="list-style-type: none"> <li>Double side tape reel</li> <li>Unroller for double sided tapes H372001</li> </ul> 	<p>Required material:</p> <ul style="list-style-type: none"> <li>AT7 tape reel</li> <li>Unroller for single sided tapes H367 0003</li> </ul> 	<p>Required material:</p> <ul style="list-style-type: none"> <li>Unroller for single sided tapes H367 0003</li> </ul>
Tips		

Refer to the product glossary for information on colours and packaging

### STORAGE EQUIPMENT

Description	Article Code	Use
NAIROD PALLET (brand new)	087Q0057	For transportation and storage of mobile court (160 × 120 × 180)
NAIROD PALLET (2 <sup>nd</sup> hand)	087Q0057	

Description	Article Code	Use
SERVING TROLLEY Portable floors	088H0001	To wind and unwind Bateco or portable floors
SERVING TROLLEY Bateco	088F0001	

Description	Article Code	Use
STORAGE RACK FOR 4 ROLLS DPP4	087E0039	For BATECO storage
STORAGE RACK FOR 4 ROLLS DPP4	088N0001	For portable floors
STORAGE RACK FOR 6 ROLLS DPP6	088O0001	For BATECO storage
STORAGE RACK FOR 6 ROLLS DPP6	088K0001	For portable floors
STORAGE RACK FOR 8 ROLLS DPP8	087B0037	For BATECO storage
STORAGE RACK FOR 8 ROLLS DPP8	088S0001	For portable floors
STORAGE RACK FOR 10 ROLLS DPP10	088J0001	For BATECO storage: Must be ordered with a frame extension pair
STATIC WALL STORAGE RACK	088E0001	

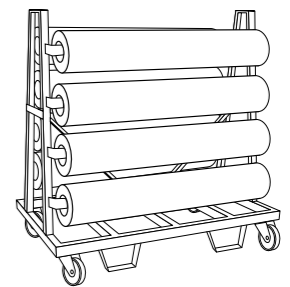
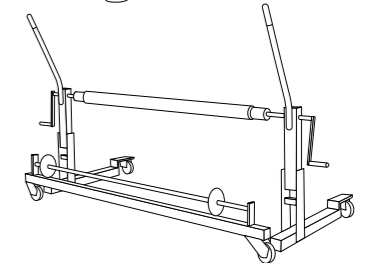
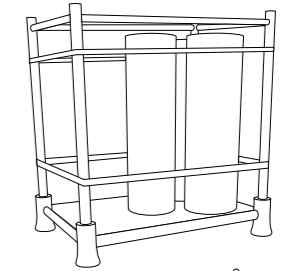

### ACCESSORIES

Description	Article code	Use
MOTORIZED UNWINDING KIT	088G0001	Motorised system to easily wind and unwind Bateco or sports floors
HOLDING STRAP	H2950001	Holding strap to prevent roll unwinding Use 2 for a 1.5m.

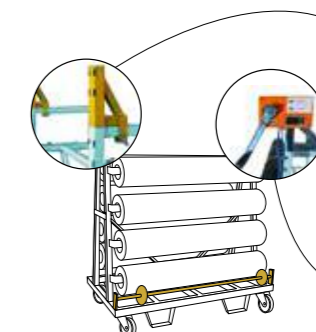

**087G0042 FRAME EXTENSION PAIR:**  
The frame extension pair is only to support the roll hoist. It enables the lifting of rolls to the highest position on roll stands.

**H4000012 ROLL HOIST PAIR:**  
indispensable device for easy upload or download of rolls.





# Specifications

pages 402-409

## 404. Gerflor specifications







# Gerflor Specifications

Education - Industry - Hotel - Restaurant

Image	Mipolam Homogeneous		Premium		Taralay Multilayered						Technical Tiles				Creation LVT					Technical Solutions			Safety Flooring			DLW Lino								
	Compact	Compact	Acoustic	Compact	Textile backing	Acoustic	Compact	Acoustic	Compact	Acoustic	Compact	Acoustic	Compact	Acoustic	Compact	Compact	Acoustic	Compact	Acoustic	Compact	Compact	Compact	Compact	Compact	Compact	Compact	Acoustic	LCH						
	Homogeneous Flooring (Evercare <sup>SM</sup> )	Homogeneous Flooring (PUR)	Premium Comfort / Taralay Millennium Acoustic	Premium Compact / Taralay Millennium Compact	Taralay Libertex	Taralay Impression Acoustic / Taralay Impression Hop Acoustic	Taralay Initial Comfort	Taralay Impression Compact / Taralay Impression Hop Compact	Taralay Initial Compact	Nerok 55/70	Tarastep Pro	Attraction®	GTI® Max / GTI® Pure	GTI EL5	Design Tile	R-Tile	Creation 55 LooseLay Acoustic	Creation Saga <sup>2</sup>	Creation Zen	Creation 70 Connect	Creation 70	Creation 55	Creation 40	Creation 30	EL5/EL7 solutions (Static control flooring)	Shower system	Wall covering	Tarasafe Ultra H2O et Tarasafe H2O	Tarasafe Ultra / Design (SparClean®)	Tarasafe Standard	Tarasafe Plus / Super	Linoleum Compact	Linoleum Acoustic	Linoleum Technical Solutions

## EDUCATION

Reception	•		•	•					•	•									•	•								•										
Corridors	•		•	•	•				•	•										•	•						•											
Classroom	•		•		•	•	•		•	•							•	•	•	•	•	•																
Dormitory room					•	•	•		•	•								•																				
Changing room																			•							•		•	•	•								
Bathroom - Toilets																									•	•	•	•	•									
Meeting - Library			•		•	•	•		•	•							•	•	•		•	•																
Computer room			•			•	•							•											•													
Laboratory	•			•				•	•					•											•		•			•								
Student's residence					•	•	•			•									•		•					•												
Student's refectory	•		•			•																																
Multipurpose room - Hall	•		•			•																																
Stairs											•																											

## INDUSTRY

Clean room / Laboratory	•			•									•													•														
Changing room	•			•											•											•														
Computer room													•												•		•													
Production	•			•									•												•				•	•	•									
Stocking and Packaging areas													•																•	•	•									
Stairs											•																													

## HOTEL - RESTAURANT

Reception				•			•	•						•					•	•	•																		
Bedroom				•		•								•					•		•	•																	
Bathroom - Toilets																									•	•	•	•	•										
Restaurant - Bar				•				•	•										•																				
Conference - Exhibition	•			•				•	•											•																			
Cinema - Show - Theatre			•			•														•																			
Stairs											•																												

• GERFLOR's recommendation    □ Other possible solutions



# Gerflor Specifications

Retail - Housing - Kitchen

	Mipolam Homogeneous		Premium		Taralay Multilayered				Technical Tiles				Creation LVT					Technical Solutions			Safety Flooring			DLW Lino		
	Compact	Compact	Acoustic	Compact	Textile backing	Acoustic	Compact	Acoustic	Compact	Compact	Compact	Acoustic	Compact	Compact	Compact	Acoustic	Compact	Compact	Compact	Compact	Compact	Compact	Compact	Compact	Acoustic	LCH
Homogeneous Flooring (Evercare™)																										
Homogeneous Flooring (PUR)																										
Premium Comfort / Taralay Millennium Acoustic																										
Premium Compact / Taralay Millennium Compact																										
Taralay Libertex																										
Taralay Impression Acoustic / Taralay Impression Hop Acoustic																										
Taralay Initial Comfort																										
Taralay Impression Compact / Taralay Impression Hop Compact																										
Taralay Initial Compact																										
Tarastep Pro																										
Attraction®																										
GTI® Max / GTI® Pure																										
GTI EL5																										
Design Tile																										
Creation 55 Loose Lay Acoustic																										
Creation Saga²																										
Creation Zen																										
Creation 70 Connect																										
Creation 70																										
Creation 55																										
Creation 40																										
Creation 30																										
EL5/EL7 solutions (Static control flooring)																										
Shower system																										
Wall covering																										
Tarasafe Ultra H2O et Tarasafe H2O																										
Tarasafe Ultra / Design (SparClean®)																										
Tarasafe Standard																										
Tarasafe Plus / Super																										
Linoleum Compact																										
Linoleum Acoustic																										
Linoleum Technical Solutions																										

## RETAIL

Shop	•			•																						
Department store				•																						
Supermarket				•																						
Cafeterias			•	•		•																				
Stocking areas																										
Stairs																										

## HOUSING

Dry Private room					•		•																			
Damp Private room							•																			
Reception area - Corridor - Landing					•		•																			
Other private home																										

## KITCHEN

Collective kitchens																										
Food preparation areas - Canteen																										

- GERFLOR's recommendation
- Other possible solutions

Installation & Maintenance instructions on [gerflor.com](http://gerflor.com)



# Notes

# Gerflor web site

New design,  
New navigation!



A website you can access on your tablet  
or smartphone everywhere!



Follow us on social media!

**Gerflor**

Be connected!



#Gerflor

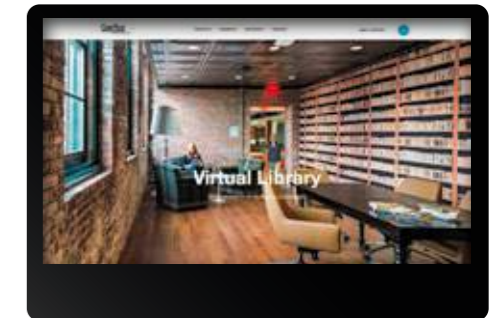

## 1 Virtual library

Access to all commercial and technical documentation that will help you developing your projects.

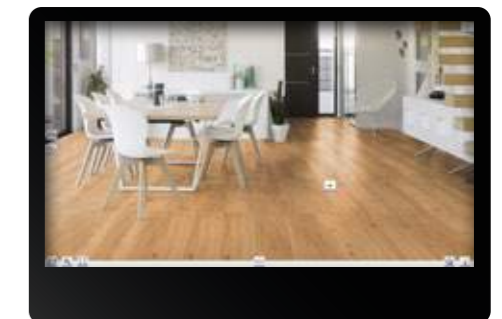

## 2 Interior designer

The Interior Designer provide you a real time simulation of the floor selected either in your own photo or in a pictures' gallery.



## 3 Store locator

Access to our distributor partners list and select the closest one.





**we care / we act** Our Commitments for a Sustainable future



**CARBON FOOTPRINT\***  
-20 % kg CO<sub>2</sub> equivalent/m<sup>2</sup> between 2020 and 2025



**BIOSOURCED CONTENT\*\***  
10 % by 2025



**RECYCLED CONTENT**  
30 % by 2025



**ADHESIVE FREE\*\*\***  
35 % by 2025



**ANNUAL VOLUME RECYCLED**  
60 000 t by 2025



\* Scopes 1 and 2 defined in the GHG protocol \*\* % of activity with biosourced materials \*\*\* % of activity - adhesive free solution